

ATV | UTV **2020**



SPRING | SUMMER | FALL | WINTER





A BRAND FOR ALL SEASONS

FROM SPRING, SUMMER, FALL TO WINTER. MOOSE UTILITY DIVISION® PROVIDES THE LARGEST SELECTION OF ATV/UTV ACCESSORIES ON THE MARKET.





FALL

NEW HARVEST | VIBRANT COLORS | CRISP AIR



PLOWS.....4-19
 WINCHES 20-25
 UTV..... 26-55
 RACKS56-63
 IMPLEMENTS & TOWING 64-73
 LUGGAGE 74-83

BODY84-93
 CONTROLS 94-105
 ELECTRICAL.....106-123
 WHEELS & TIRES124-163
 SUSPENSION & DRIVE164-229
 BRAKING 230-241

ENGINE242-265
 RIDER.....266-273
 GARAGE.....274-281
 PROMO..... 282-283



WINTER

SHORTER DAYS | COLD TEMPS | FRESH POWDER







PROMO
GARAGE
RIDER
ENGINE
BRAKING
SUSPENSION & DRIVE
WHEELS & TIRES
ELECTRICAL
CONTROLS
BODY
LUGGAGE
IMPLEMENTS & TOWING
RACKS
UTV
WINCHES
PLOWS

PLOWS

STANDARD PLOW BLADES

Formed from 11-gauge steel, plow blade has a curved design that provides better snow/dirt roll-off at any angle. Strong matte, powder coated finish. Our standard 127 cm (50") blade clears a 113 cm (44 ½") path when angled and our 152 cm (60") blade clears 136 cm (53 ½") path when angled. The 183 cm (72") blade is designed for utility vehicles, ATVs 500cc and larger and clears a 163 cm (64") path when angled. Rubber plow flap sold separately (See page 18). 168 cm (66") and 183 cm (72") blades come standard with plow flap. Side shield sold separately (See page 18).
Made in the USA.

DESCRIPTION	BLADE HEIGHT	PART #
STANDARD PLOW BLADE		
107 CM (42") YELLOW BLADE	38 CM (15")	4501-0750
127 CM (50") YELLOW BLADE	38 CM (15")	4501-0751
127 CM (50") BLACK BLADE	38 CM (15")	4501-0752
140 CM (55") YELLOW BLADE	38 CM (15")	4501-0753
152 CM (60") YELLOW BLADE	38 CM (15")	4501-0754
152 CM (60") BLACK BLADE	38 CM (15")	4501-0776
168 CM (66") YELLOW BLADE	43 CM (17")	4501-0755
168 CM (66") BLACK BLADE	43 CM (17")	4501-0777
183 CM (72") YELLOW BLADE	43 CM (17")	4501-0756
183 CM (72") BLACK BLADE	43 CM (17")	4501-0778

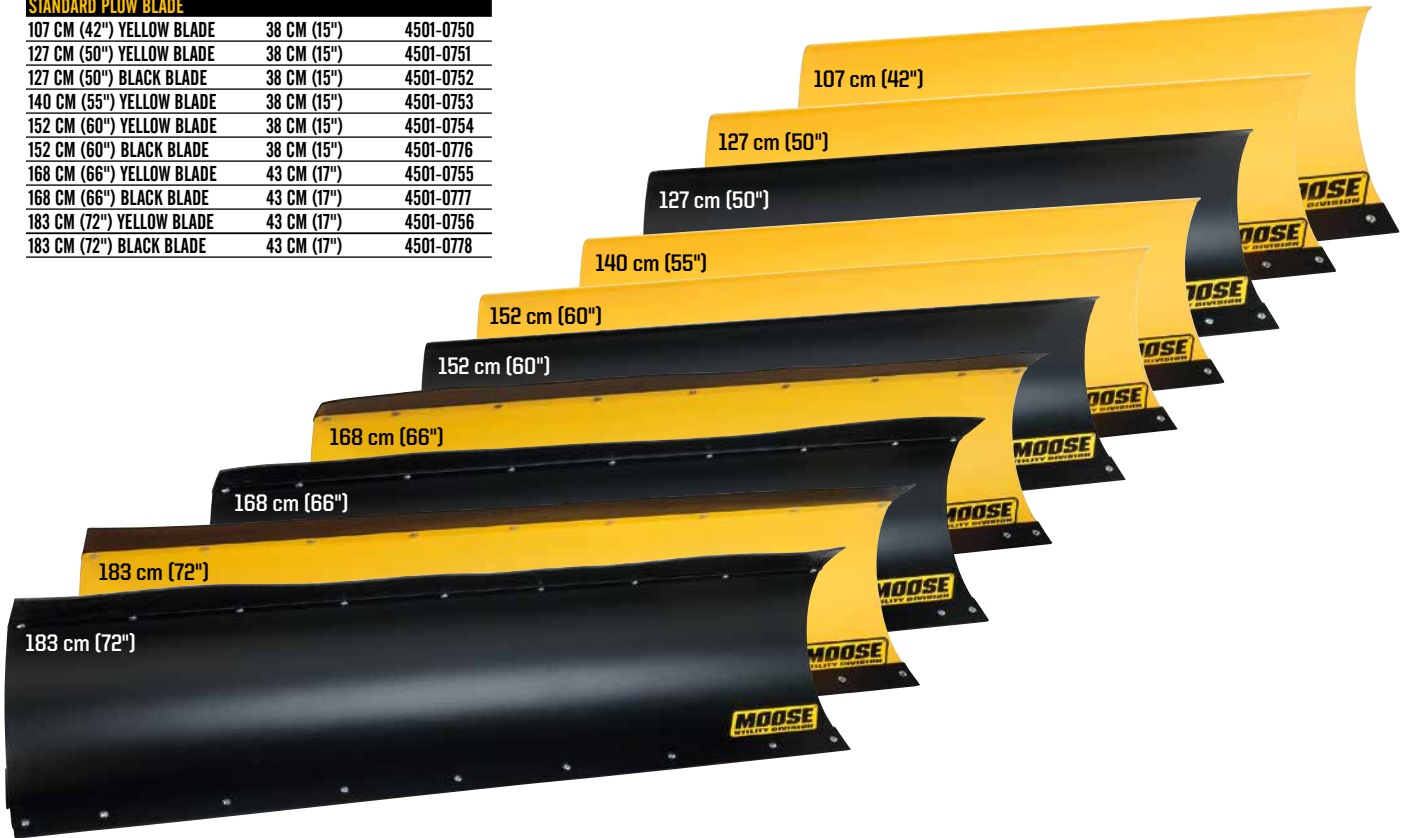

COUNTY PLOW BLADES

Features a "wing" design and blade curve that guides snow up and away from the surface you're clearing. Strong matte, powder coated finish. The height of the wing measures 66 cm (26") tall with the plow tapering down to 40,5 cm (16") at the end. Standard rubber plow flap helps keep snow from blowing up and over into your face. Made in the USA.

DESCRIPTION	BLADE HEIGHT	PART #
COUNTY PLOW BLADE		
127 CM (50") YELLOW BLADE	40,5 CM (16") - 66 CM (26")	4501-0757
152 CM (60") YELLOW BLADE	40,5 CM (16") - 66 CM (26")	4501-0758



WHAT TO ORDER FOR A COMPLETE PLOW SETUP

CHOICE OF PLOW BLADE AND SIZE: STANDARD BLADE OR COUNTY BLADE
 CHOICE OF PLOW SYSTEM: RM4 OR PUSH TUBE/BOTTOM MOUNT (SEE FOLLOWING PAGES)

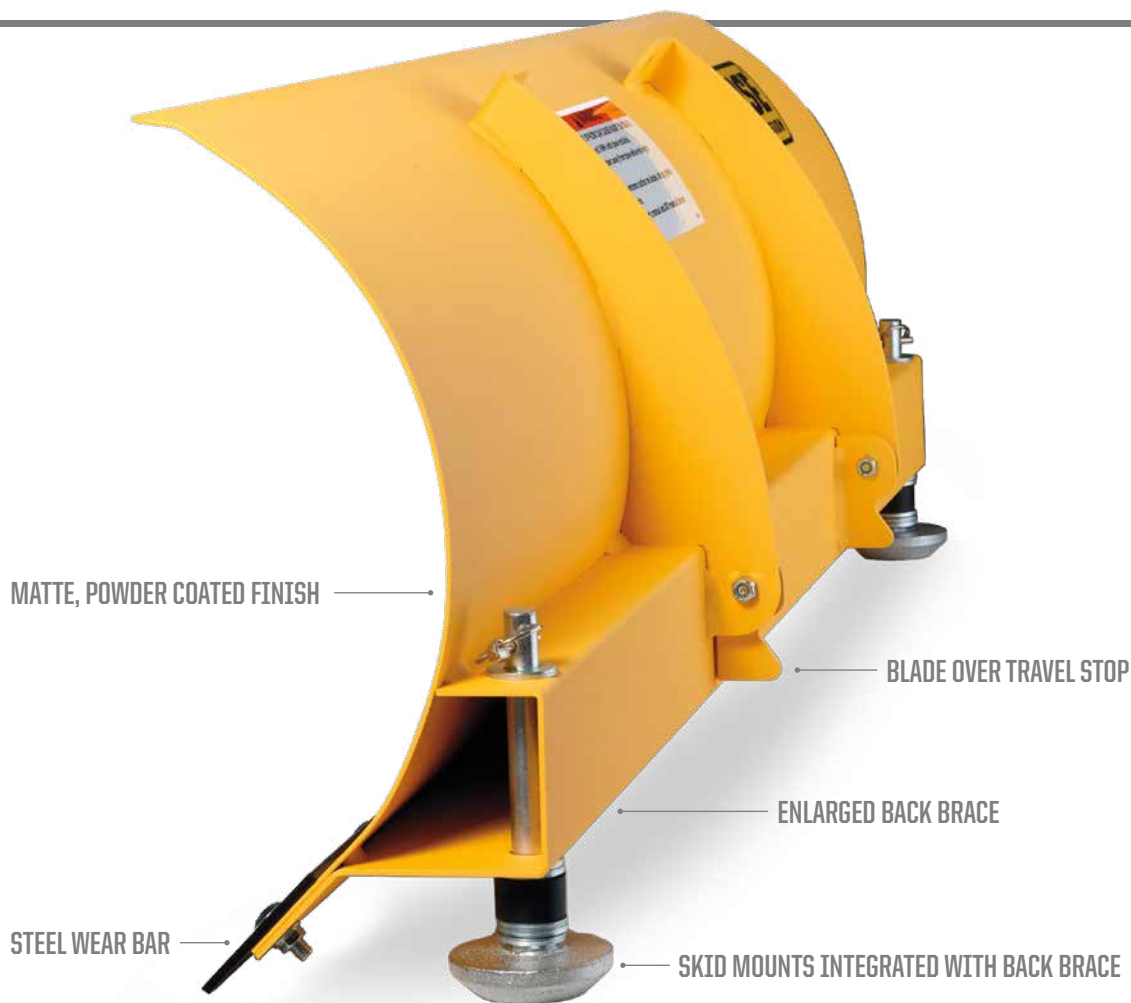



FOR ATV'S

Tailgate style latch for easy on and off. Receiver-style mount is easily removed. Increased strength of the bottom support plates. Triangulated front mount push tube for maximum strength and stability. 76 cm (30") of lift height on some models. Works with all current RM4 ATV mount plates. Fits all straight or county blades up to 183 cm (72"). Made in the USA.

RECEIVER STYLE MOUNT



76 cm
(30")
LIFT
HEIGHT

WHAT TO ORDER



CHOICE OF PLOW BLADE **1**



PLOW FRAME **2**

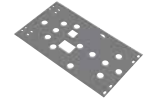

MOUNT PLATE **3**



WINCH MOUNT **4**



CHOICE OF WINCH **5**



PULLEY KIT **6**

CHOICE OF PLOW BLADE	BLADE HEIGHT	PART #
STANDARD PLOW BLADE		
107 CM (42") YELLOW BLADE	38 CM (15")	4501-0750
127 CM (50") YELLOW BLADE	38 CM (15")	4501-0751
127 CM (50") BLACK BLADE	38 CM (15")	4501-0752
140 CM (55") YELLOW BLADE	38 CM (15")	4501-0753
152 CM (60") YELLOW BLADE	38 CM (15")	4501-0754
152 CM (60") BLACK BLADE	38 CM (15")	4501-0776
168 CM (66") YELLOW BLADE	43 CM (17")	4501-0755
168 CM (66") BLACK BLADE	43 CM (17")	4501-0777
183 CM (72") YELLOW BLADE	43 CM (17")	4501-0756
183 CM (72") BLACK BLADE	43 CM (17")	4501-0778
COUNTY PLOW BLADE		
127 CM (50") YELLOW BLADE	40,5 CM (16") - 66 CM (26")	4501-0757
152 CM (60") YELLOW BLADE	40,5 CM (16") - 66 CM (26")	4501-0758

CHOICE OF WINCH **SEE PAGES 22 - 23**

FITS MODEL	PLOW FRAME	MOUNT PLATE	WINCH MOUNT	PULLEY KIT
ARCTIC CAT				
400 06-11	4501-0763	4501-0810	4505-0635	4501-0699
450 10-12	4501-0763	4501-0810	4505-0635	4501-0699
500 06-14	4501-0763	4501-0810	4505-0635	4501-0699
500 XR 15	4501-0763	4501-0670	4505-0635	4501-0699
500 ALTERA XT EFI 16	4501-0763	4501-0670	4505-0635	4501-0699
550 09-13	4501-0763	4501-0810	4505-0635	4501-0699
650 05-11	4501-0763	4501-0810	4505-0635	4501-0699
700 07-14	4501-0763	4501-0810	4505-0635	4501-0699
700 XR 15	4501-0763	4501-0670	4505-0635	4501-0699
700 ALTERA XT EFI 16	4501-0763	4501-0670	4505-0635	4501-0699
1000 09-13	4501-0763	4501-0810	4505-0635	4501-0699
CAN-AM				
OUTLANDER 400 06-14	4501-0763	4501-0787 ¹	4505-0640	4501-0699
OUTLANDER / MAX 450L 4X4 15-17	4501-0763	4501-0671	-	4501-0699
OUTLANDER 500 07-12	4501-0763	4501-0787	4505-0638	4501-0699
OUTLANDER 500 13-14	4501-0763	4501-0811	-	4501-0699
OUTLANDER 500L 4X4 15	4501-0763	4501-0671	-	4501-0699
OUTLANDER 570L 16-19	4501-0763	4501-0671	-	4501-0699
OUTLANDER MAX 570 XT 19	4501-0763	4501-0671	-	4501-0699
OUTLANDER 650 06-12	4501-0763	4501-0787	4505-0638	4501-0699
OUTLANDER 650 13-15	4501-0763	4501-0811	-	4501-0699
OUTLANDER 650 MAX XT 17-19	4501-0763	4501-0671	-	4501-0699
OUTLANDER 800 06-11	4501-0763	4501-0787	4505-0638	4501-0699
OUTLANDER 800 R 12-15	4501-0763	4501-0811	-	4501-0699
OUTLANDER 850 16-18	4501-0763	4501-0671	-	4501-0699
OUTLANDER 1000 R 12-17	4501-0763	4501-0811	-	4501-0699
HONDA				
RANCHER 420 07-13	4501-0763	4501-0786	4505-0360 ²	4501-0699
RANCHER 420 14 (IRS MODEL ONLY)	4501-0763	4501-0786	4505-0360	4501-0699
RANCHER 420 15-16 (IRS MODEL ONLY)	4501-0763	4501-0789	4505-0633 ⁴	4501-0699
RANCHER 420 15-16 (IRS MODEL ONLY)	4501-0763	4501-0789	4505-0753 ⁵	4501-0699
RANCHER 420 14-19 (STRAIGHT AXLE)	4501-0763	4501-0789	4505-0633 ⁴	4501-0699
RANCHER 420 14-19 (STRAIGHT AXLE)	4501-0763	4501-0789	4505-0753 ⁵	4501-0699
FOREMAN 500 12-13	4501-0763	4501-0426	4505-0631	4501-0699
FOREMAN 500 14 -17	4501-0763	4501-0789	4505-0633 ⁴	4501-0699
FOREMAN 500 14 -17	4501-0763	4501-0789	4505-0753 ⁵	4501-0699
RUBICON 500 15-18	4501-0763	4501-0789	4505-0633 ⁴	4501-0699
RUBICON 500 15-18	4501-0763	4501-0789	4505-0753 ⁵	4501-0699
RINCON 650/680 03-15	4501-0763	4501-0769	4505-0642	4501-0699

FITS MODEL	PLOW FRAME	MOUNT PLATE	WINCH MOUNT	PULLEY KIT
KAWASAKI				
BRUTE FORCE 650 (IND. SUSP.) 11-12	4501-0763	4501-0766	4505-0654	4501-0699
BRUTE FORCE 750 08-18	4501-0763	4501-0766	4505-0654	4501-0699
POLARIS				
SPORTSMAN 400 11-14	4501-0763	4501-0772	4505-0672	4501-0699
SPORTSMAN 450 4X4 16-18	4501-0763	4501-0812	4505-0672	4501-0699
SPORTSMAN 500 11-13	4501-0763	4501-0772	4505-0672	4501-0699
SPORTSMAN 550 XP (INCLUDING TOURING) 09-14	4501-0763	4501-0772	4505-0672	4501-0699
SPORTSMAN 550 X2 14	4501-0763	4501-0772	4505-0672	4501-0699
SPORTSMAN 570 4X4 14	4501-0763	4501-0772	4505-0672	4501-0699
SPORTSMAN 570 4X4 16-18	4501-0763	4501-0812	4505-0672	4501-0699
SPORTSMAN 570 4X4 SP 15-17	4501-0763	4501-0812	4505-0672	4501-0699
SPORTSMAN 570 TOURING EPS 15-17	4501-0763	4501-0812	4505-0672	4501-0699
SPORTSMAN 800 11-14	4501-0763	4501-0772	4505-0672	4501-0699
SPORTSMAN 850 XP (INCLUDING TOURING) 09-14	4501-0763	4501-0660	4505-0672	4501-0699
SCRAMBLER XP 850 13-14	4501-0763	4501-0660	4505-0672	4501-0699
SCRAMBLER 850 16	4501-0763	4501-0767	4505-0672	4501-0699
SPORTSMAN 850 SP 15-16	4501-0763	4501-0767	4505-0672	4501-0699
SPORTSMAN 850 XP 15-16	4501-0763	4501-0767	4505-0672	4501-0699
SPORTSMAN 850 HO 16-17	4501-0763	4501-0767	4505-0672	4501-0699
SCRAMBLER 1000 15-16	4501-0763	4501-0767	4505-0672	4501-0699
SPORTSMAN 1000 15-18	4501-0763	4501-0767	4505-0672	4501-0699
SUZUKI				
KING QUAD 450 07-10	4501-0763	4501-0797	4505-0656 ³	4501-0699
KING QUAD 500 09-19	4501-0763	4501-0797	4505-0656 ³	4501-0699
KING QUAD 700 05-07	4501-0763	4501-0797	4505-0656 ³	4501-0699
KING QUAD 750 08-19	4501-0763	4501-0797	4505-0656 ³	4501-0699
YAMAHA				
KODIAK 450 18-19	4501-0763	4501-0590	-	4501-0699
GRIZZLY 550 09-15	4501-0763	4501-0773	4505-0653	4501-0699
GRIZZLY 700 07-15	4501-0763	4501-0773	4505-0653	4501-0699
GRIZZLY 700 16-19	4501-0763	4501-0790	4505-0634	4501-0699
KODIAK 700 16-17	4501-0763	4501-0790	4505-0634	4501-0699

¹ MUST USE CAN-AM WINCH MOUNT ON OUTLANDER 400

² NOT FOR USE WITH MOOSE UTILITY DIVISION® 3700 LB. WINCH OR TERRA SERIES 2500/4500

³ MUST USE WITH MOOSE UTILITY DIVISION® FAIRLAD PART #4505-0704

⁴ NOT FOR TWO-BOLT WINCHES

⁵ IF USING MOOSE UTILITY DIVISION® VRX WINCHES, 2500/3500



Tailgate style latch for easy on and off. Receiver-style mount is easily removed.
Increased strength of the bottom support plates. Triangulated front mount push tube for maximum strength and stability. 76 cm (30") of lift height on some models. Works with all current RM4 UTV mount plates. Fits all straight or county blades up to 183 cm (72").
Made in the USA.

RECEIVER STYLE MOUNT



**30"
LIFT
HEIGHT**

WHAT TO ORDER



CHOICE OF PLOW BLADE **1**



PLOW FRAME **2**

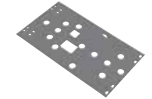

MOUNT PLATE **3**



WINCH MOUNT **4**



CHOICE OF WINCH **5**

CHOICE OF PLOW BLADE	BLADE HEIGHT	PART #
STANDARD PLOW BLADE		
107 CM (42") YELLOW BLADE	38 CM (15")	4501-0750
127 CM (50") YELLOW BLADE	38 CM (15")	4501-0751
127 CM (50") BLACK BLADE	38 CM (15")	4501-0752
140 CM (55") YELLOW BLADE	38 CM (15")	4501-0753
152 CM (60") YELLOW BLADE	38 CM (15")	4501-0754
152 CM (60") BLACK BLADE	38 CM (15")	4501-0776
168 CM (66") YELLOW BLADE	43 CM (17")	4501-0755
168 CM (66") BLACK BLADE	43 CM (17")	4501-0777
183 CM (72") YELLOW BLADE	43 CM (17")	4501-0756
183 CM (72") BLACK BLADE	43 CM (17")	4501-0778
COUNTY PLOW BLADE		
127 CM (50") YELLOW BLADE	40,5 CM (16") - 66 CM (26")	4501-0757
152 CM (60") YELLOW BLADE	40,5 CM (16") - 66 CM (26")	4501-0758

CHOICE OF WINCH **SEE PAGES 22 - 23**

FITS MODEL	PLOW FRAME	MOUNT PLATE	WINCH MOUNT
ARCTIC CAT			
PROWLER HDX XT 16	4501-0764	4501-0807	-
PROWLER HDX CREW 17	4501-0764	4501-0807	-
CAN-AM			
COMMANDER 800/1000 11-19	4501-0764	4501-0658	4505-0694
DEFENDER HD10 800 16-18	4501-0764	4501-0659	4505-0592
CF MOTO			
TRAIL Z-FORCE 500/800 17-19	4501-0764	4501-0808	-
HONDA			
PIONEER 500 15-19	4501-0764	4501-0805	4505-0693
PIONEER 700/PIONEER 700-4 14-19	4501-0764	4501-0765	4505-0688
PIONEER 1000 / 1000-5 16-19	4501-0764	4501-0792	4505-0702 ³
KAWASAKI			
MULE 610 05-16	4501-0764	4501-0435 ²	4505-0677
TERYX 750 4X4 08-13	4501-0764	4501-0796	4505-0678
TERYX 750 4 (4-SEATER) 4X4 12-14	4501-0764	4501-0796	4505-0685
TERYX 800 & 4 14-19	4501-0764	4501-0796	4505-0685
MULE PRO-FXT 15-19	4501-0764	4501-0791	4505-0700
MULE PRO FX 18	4501-0764	4501-0791	4505-0700
MULE PRO DX 16	4501-0764	4501-0791	4505-0700
MULE SX 4X4 17	4501-0764	4501-0793	4505-0677
MULE 4010 09-16 (NOT FOR DIESEL)	4501-0764	4501-0802 ¹	-
POLARIS			
RANGER 325 ETX 15-16	4501-0764	4501-0770	4505-0692
RANGER 400 10-13	4501-0764	4501-0770	4505-0692
RANGER 500 09-10	4501-0764	4501-0770	4505-0689
RANGER 500 11-13 (INCLUDING CREW MODEL)	4501-0764	4501-0770	4505-0692
RANGER 500 18 (MIDSIZE)	4501-0764	4501-0770	4505-0692
RANGER 570 MIDSIZE 14-18	4501-0764	4501-0770	4505-0692
RANGER 570 XP FULLSIZE 15-16	4501-0764	4501-0804	4505-0681
RANGER 570 FULLSIZE 16-19	4501-0764	4501-0770	4505-0692
RZR 570 TRAIL 12-16	4501-0764	4501-0771	4505-0682
RANGER 700/800 09-14 (WILL NOT FIT 09 CREW MODEL)	4501-0764	4501-0770	4505-0689
RANGER 800 MIDSIZE 13-14	4501-0764	4501-0770	4505-0692
RANGER DIESEL 11	4501-0764	4501-0770	4505-0689
RANGER EV (ELECTRIC) 12	4501-0764	4501-0770	4505-0692
RANGER 900 XP (INCLUDING CREW) 13-19	4501-0764	4501-0804	4505-0681
RANGER 1000 XP 17	4501-0764	4501-0804	4505-0681
RANGER 1000 CREW XP 18	4501-0764	4501-0804	4505-0681
RANGER 1000 18	4501-0764	4501-0836	4505-0681
GENERAL 17-19	4501-0764	4501-0575	4505-0689
YAMAHA			
RHINO 700 08-13	4501-0764	4501-0801	4505-0679
VIKING 700/VIKING VI 700 14-19	4501-0764	4501-0788	4505-0529
WOLVERINE R-SPEC 15-18	4501-0764	4501-0798	4505-0580
WOLVERINE X2/X4 18-19	4501-0764	4501-0798	4505-0746

¹ MUST BE USED WITH KAWASAKI WINCH MOUNT ² REQUIRES PULLEY KIT PART #4501-0699
³ ONLY WORKS WITH 4000/4500 WINCH



PLOWS

WINCHES

UTV

RACKS

IMPLEMENTS & TOWING

LUGGAGE

BODY

CONTROLS

ELECTRICAL

WHEELS & TIRES

SUSPENSION & DRIVE

BRAKING

ENGINE

RIDER

GARAGE

PROMO

PUSH TUBE | BOTTOM MOUNT SYSTEM

WHAT TO ORDER



CHOICE OF PLOW BLADE **1**



BOTTOM MOUNT **2**



CHOICE OF PUSH TUBE **3**



CHOICE OF LIFT SYSTEM **4**



IF WINCH MOUNT LIFT SYSTEM IS CHOSEN:
CHOICE OF WINCH **5**

CHOICE OF PLOW BLADE	BLADE HEIGHT	PART #
STANDARD PLOW BLADE		
107 CM (42") YELLOW BLADE	38 CM (15")	4501-0750
127 CM (50") YELLOW BLADE	38 CM (15")	4501-0751
127 CM (50") BLACK BLADE	38 CM (15")	4501-0752
140 CM (55") YELLOW BLADE	38 CM (15")	4501-0753
152 CM (60") YELLOW BLADE	38 CM (15")	4501-0754
152 CM (60") BLACK BLADE	38 CM (15")	4501-0776
168 CM (66") YELLOW BLADE	43 CM (17")	4501-0755
168 CM (66") BLACK BLADE	43 CM (17")	4501-0777
183 CM (72") YELLOW BLADE	43 CM (17")	4501-0756
183 CM (72") BLACK BLADE	43 CM (17")	4501-0778
COUNTY PLOW BLADE		
127 CM (50") YELLOW BLADE	40,5 CM (16") - 66 CM (26")	4501-0757
152 CM (60") YELLOW BLADE	40,5 CM (16") - 66 CM (26")	4501-0758

CHOICE OF WINCH SEE PAGES 22 - 23

FITS MODEL	REQUIRED: BOTTOM MOUNT PART #	OPTION 1: PUSH TUBE FOR WINCH OR ELECTRIC LIFT PART #	OPTION 2: PUSH TUBE FOR UNIVERSAL HAND LIFT PART #	OPTION 1: UNIVERSAL HAND LIFT PART #	OPTION 2: WINCH MOUNT PART #	OPTION 3: ELECTRIC LIFT PART #
ARCTIC CAT/TEXTRON						
250 4X4 01	4501-0625	4501-0759	4501-0760	4501-0785	4505-0667	4501-0309
300 4X4 MRP 5-SPEED 04-05	4501-0625	4501-0759	4501-0760	4501-0785	4505-0668	4501-0309
300 4X4 98-01	4501-0625	4501-0759	4501-0760	4501-0785	4505-0667	4501-0309
300 5-SPEED 3-RANGE 4X4 02-03	4501-0625	4501-0759	4501-0760	4501-0785	4505-0668	4501-0309
350 4X4 12	4501-0603	4501-0759	4501-0760	4501-0785	-	4501-0309
366 4X4 08-09	4501-0603	4501-0759	4501-0760	4501-0785	4505-0636	4501-0309
375 AUTOMATIC 4X4 02	4501-0625	4501-0759	4501-0760	4501-0785	4505-0668	4501-0309
ALTERRA 400 4X4 16	4501-0606	4501-0759	4501-0760	4501-0785	-	4501-0309
ALTERRA 400 4X4 17	4501-0606	4501-0759	4501-0760	4501-0785	4505-0630	4501-0309
400 4X4 98-01	4501-0625	4501-0759	4501-0760	4501-0785	4505-0667	4501-0309
400 4X4 06-11	4501-0625	4501-0759	4501-0760	4501-0785	4505-0635	4501-0309
400 4X4 02-05	4501-0625	4501-0759	4501-0760	4501-0785	4505-0668	4501-0309
400 4X4 14	4501-0603	4501-0759	4501-0760	4501-0785	-	4501-0309
400 4X4 TBX 04	4501-0625	4501-0759	4501-0760	4501-0785	4505-0668	4501-0309
400 4X4 TRV 06-10	4501-0625	4501-0759	4501-0760	4501-0785	4505-0635	4501-0309
425 I 4X4 12	4501-0603	4501-0759	4501-0760	4501-0785	4505-0636	-
450 4X4 11	4501-0625	4501-0759	4501-0760	4501-0785	4505-0635	4501-0309
450 4X4 14	4501-0603	4501-0759	4501-0760	4501-0785	-	4501-0309
454 4X4 BEAR CAT 96-98	4501-0625	4501-0759	4501-0760	4501-0785	4505-0667	4501-0309
500 4X4 99-01	4501-0625	4501-0759	4501-0760	4501-0785	4505-0667	4501-0309
500 4X4 02-04	4501-0625	4501-0759	4501-0760	4501-0785	4505-0668	4501-0309
500 4X4 06-09	4501-0625	4501-0759	4501-0760	4501-0785	4505-0635	4501-0309
500 4X4 TBX/TRV 03-05	4501-0625	4501-0759	4501-0760	4501-0785	4505-0668	4501-0309
500 4X4 14	4501-0625	4501-0759	4501-0760	4501-0785	4505-0635	4501-0309
500 XR 15	4501-0531	4501-0759	4501-0760	4501-0785	4505-0635	4501-0309
500 ALTERRA XT EFI 16	4501-0531	4501-0759	4501-0760	4501-0785	4505-0635	4501-0309
550 4X4 09-11	4501-0625	4501-0759	4501-0760	4501-0785	4505-0635	4501-0309
550 TRV-2 UP 09-12	4501-0625	4501-0759	4501-0760	4501-0785	4505-0635	4501-0309
650 4X4 04	4501-0625	4501-0759	4501-0760	4501-0785	4505-0668	4501-0309
650 4X4 05-10	4501-0625	4501-0759	4501-0760	4501-0785	4505-0635	4501-0309
650 4X4 MUD PRO 2010	4501-0625	4501-0759	4501-0760	4501-0785	-	4501-0309
650 TBX 07	4501-0625	4501-0759	4501-0760	4501-0785	4505-0635	4501-0309
700 4X4 07-11	4501-0625	4501-0759	4501-0760	4501-0785	4505-0635	4501-0309

FITS MODEL	REQUIRED: BOTTOM MOUNT PART #	REQUIRED: PUSH TUBE FOR WINCH OR ELECTRIC LIFT PART #	REQUIRED: PUSH TUBE FOR UNIVERSAL HAND LIFT PART #	OPTION 1: UNIVERSAL HAND LIFT PART #	OPTION 2: WINCH MOUNT PART #	OPTION 3: ELECTRIC LIFT PART #
ARCTIC CAT/TEXTRON (CON'T)						
700 4X4 MUD PRO 10-12	4501-0625	4501-0759	4501-0760	4501-0785	-	4501-0309
700 4X4 TRV/TBX 14	4501-0625	4501-0759	4501-0760	4501-0785	4505-0635	4501-0309
700 XR 15	4501-0531	4501-0759	4501-0760	4501-0785	4505-0635	4501-0309
700 ALTERRA XT EFI 16	4501-0531	4501-0759	4501-0760	4501-0785	4505-0635	4501-0309
700 ALTERRA TRV XT 17	4501-0625	4501-0759	4501-0760	4501-0785	-	4501-0309
1000 THUNDERCAT 08	4501-0625	4501-0759	4501-0760	4501-0785	4505-0635	4501-0309
500 PROWLER HDX XT 14	4501-0630	4501-0761	-	-	4505-0465	-
550 PROWLER 09	4501-0630	4501-0761	-	-	-	-
550 PROWLER 10-12	4501-0630	4501-0761	-	-	-	-
650 PROWLER 06-09	4501-0630	4501-0761	-	-	-	-
700 PROWLER 08-09	4501-0630	4501-0761	-	-	-	-
700 PROWLER 10-13	4501-0630	4501-0761	-	-	4505-0465	-
700 PROWLER 14-15	4501-0630	4501-0761	-	-	-	-
WILDCAT TRAIL 700 14-17	4501-0495	4501-0761	-	-	-	-
1000 PROWLER 09	4501-0630	4501-0761	-	-	-	-
1000 PROWLER 10-13	4501-0630	4501-0761	-	-	4505-0465	-
STAMPEDE 16-18	4501-0831	4501-0761	-	-	-	-
CAN-AM						
OUTLANDER 330 H.O. 4X4 04-08	4501-0627	4501-0759	4501-0760	4501-0785	4505-0640	4501-0309
OUTLANDER MAX 400 4X4 06-12	4501-0627	4501-0759	4501-0760	4501-0785	4505-0640	4501-0309
OUTLANDER 400 4X4 03-11	4501-0627	4501-0759	4501-0760	4501-0785	4505-0640	4501-0309
OUTLANDER 400 4X4 13-14	4501-0627	4501-0759	4501-0760	4501-0785	4505-0640	4501-0309
OUTLANDER 450L / MAX 4X4 15-19	4501-0627	4501-0759	4501-0760	4501-0785	-	4501-0309
RENEGADE 500 4X4 07-11	4501-0627	4501-0759	4501-0760	4501-0785	-	4501-0309
RENEGADE 500 4X4 13-14	4501-0627	4501-0759	4501-0760	4501-0785	-	4501-0309
TRAXTER 500 03-05	4501-0626	4501-0759	4501-0760	4501-0785	4505-0641	4501-0309
TRAXTER MAX 500 03-04	4501-0626	4501-0759	4501-0760	4501-0785	4505-0641	4501-0309
TRAXTER & XL 500 4X4 99-03	4501-0626	4501-0759	4501-0760	4501-0785	4505-0641	4501-0309
OUTLANDER 500 MAX 07-14	4501-0627	4501-0759	4501-0760	4501-0785	4505-0638	4501-0309
OUTLANDER 500 07-11	4501-0627	4501-0759	4501-0760	4501-0785	4505-0638	4501-0309
OUTLANDER 500 13-15	4501-0627	4501-0759	4501-0760	4501-0785	-	4501-0309
OUTLANDER 570 XT (ALL) 15-19	4501-0627	4501-0759	4501-0760	4501-0785	-	4501-0309
OUTLANDER 650 & MAX 06-18	4501-0627	4501-0759	4501-0760	4501-0785	4505-0638	4501-0309
QUEST 650 XT 4X4 02-03	4501-0626	4501-0759	4501-0760	4501-0785	4505-0641	4501-0309
TRAXTER MAX XT 650 4X4 05	4501-0626	4501-0759	4501-0760	4501-0785	-	4501-0309
OUTLANDER 800 06-11	4501-0627	4501-0759	4501-0760	4501-0785	4505-0638	4501-0309
OUTLANDER 800 12-13	4501-0627	4501-0759	4501-0760	4501-0785	-	4501-0309
OUTLANDER 800 MAX 06-11	4501-0627	4501-0759	4501-0760	4501-0785	4505-0638	4501-0309
OUTLANDER 800 MAX 12-15	4501-0627	4501-0759	4501-0760	4501-0785	4505-0638	4501-0309
RENEGADE 800 4X4 07-14	4501-0627	4501-0759	4501-0760	4501-0785	-	4501-0309
OUTLANDER XT 850 17-18	4501-0627	4501-0759	4501-0760	4501-0785	-	4501-0309
OUTLANDER 1000R 12-14	4501-0627	4501-0759	4501-0760	4501-0785	-	4501-0309
OUTLANDER 1000XT & MAX 14-16	4501-0627	4501-0759	4501-0760	4501-0785	-	4501-0309
RENEGADE 1000 XC 4X4 12-17	4501-0627	4501-0759	4501-0760	4501-0785	-	4501-0309
RENEGADE XMR 1000 18	4501-0627	4501-0759	4501-0760	4501-0785	-	4501-0309
DEFENDER 800 16-17	4501-0648	4501-0761	-	-	4505-0592	-
DEFENDER XT HD-8 18	4501-0648	4501-0761	-	-	-	-
COMMANDER 800 11-14	4501-0635	4501-0761	-	-	4505-0694	-
COMMANDER 1000 11-14	4501-0635	4501-0761	-	-	4505-0694	-
COMMANDER 800/1000 15-17	4501-0488	4501-0761	-	-	4505-0694	-
COMMANDER 1000-4 15-19	4501-0488	4501-0761	-	-	4505-0694	-
MAVERICK 1000R/TURBO 13-15	4501-0646	4501-0761	-	-	4505-0695	-
CF MOTO						
CF400AU 16	4501-0602	4501-0759	4501-0760	4501-0785	-	4501-0309
X5 500 4X4 12-13	4501-0602	4501-0759	4501-0760	4501-0785	-	4501-0309
X6 600 4X4 12-13	4501-0602	4501-0759	4501-0760	4501-0785	-	4501-0309
X8 800 4X4 12-13	4501-0602	4501-0759	4501-0760	4501-0785	-	4501-0309
C-FORCE 800 14-16	4501-0602	4501-0759	4501-0760	4501-0785	-	4501-0309
C-FORCE 500 CLASSIC 15-16	4501-0602	4501-0759	4501-0760	4501-0785	-	4501-0309
C-FORCE 500AU-6L 2-UP 15-16	4501-0602	4501-0759	4501-0760	4501-0785	-	4501-0309
U-FORCE 800 14-15	4501-0649	4501-0761	-	-	-	-
U-FORCE 500 16	4501-0649	4501-0761	-	-	-	-
Z-FORCE 800 16-19	4501-0650	4501-0761	-	-	-	-
GOES						
520 MAX	4501-0623	4501-0475	4501-0760	4501-0785	-	4501-0309
G520 UTX (SIDE X SIDE)	4501-0623	4501-0475	4501-0760	4501-0785	-	4501-0309
G525 MAX (4X4)	4501-0623	4501-0475	4501-0760	4501-0785	-	4501-0309
HONDA						
TRX250 RECON 2X4/ES 04-16	4501-0594	4501-0759	4501-0760	4501-0785	4505-0661	4501-0309
TRX300 2X4/4X4 93-00	4501-0594	4501-0759	4501-0760	4501-0785	4505-0664	4501-0309
TRX350 S/ES 2X4/4X4 RANCHER 00-06	4501-0596	4501-0759	4501-0760	4501-0785	4505-0663	4501-0309
TRX400 FOREMAN 4X4 95-01	4501-0596	4501-0759	4501-0760	4501-0785	4505-0657	4501-0309
TRX400AT S/ES 4X4 RANCHER 04-07	4501-0596	4501-0759	4501-0760	4501-0785	4505-0663	4501-0309
TRX420 EFI RANCHER 07-14	4501-0595	4501-0759	4501-0760	4501-0785	4505-0360 ²	4501-0309
TRX420 EFI RANCHER 14-19 (STRAIGHT AXLE)	4501-0595	4501-0759	4501-0760	4501-0785	4505-0633 ⁶	4501-0309
TRX420 EFI RANCHER 14-19 (STRAIGHT AXLE)	4501-0595	4501-0759	4501-0760	4501-0785	4505-0753 ⁸	4501-0309
TRX420 EFI RANCHER 15-19 (IRS)	4501-0595	4501-0759	4501-0760	4501-0785	4505-0633 ⁶	4501-0309
TRX420 EFI RANCHER 15-19 (IRS)	4501-0595	4501-0759	4501-0760	4501-0785	4505-0753 ⁸	4501-0309
TRX450S/ES FOREMAN 4X4 98-04	4501-0596	4501-0759	4501-0760	4501-0785	4505-0657	4501-0309
TRX500 FOREMAN ES 05-06	4501-0596	4501-0759	4501-0760	4501-0785	4505-0643	4501-0309
TRX500 FOREMAN ES 07-08	4501-0596	4501-0759	4501-0760	4501-0785	4505-0632	4501-0309
TRX500 FOREMAN ES 09-11	4501-0596	4501-0759	4501-0760	4501-0785	4505-0632	4501-0309
TRX500 FOREMAN 12-13	4501-0412	4501-0759	4501-0760	4501-0785	4505-0631	4501-0309

FITS MODEL	REQUIRED: BOTTOM MOUNT PART #	REQUIRED: PUSH TUBE FOR WINCH OR ELECTRIC LIFT PART #	REQUIRED: PUSH TUBE FOR UNIVERSAL HAND LIFT PART #	OPTION 1: UNIVERSAL HAND LIFT PART #	OPTION 2: WINCH MOUNT PART #	OPTION 3: ELECTRIC LIFT PART #
HONDA (CON'T)						
TRX500 FOREMAN 14-17	4501-0595	4501-0759	4501-0760	4501-0785	4505-0633 ⁶	4501-0309
TRX500 FOREMAN 14-17	4501-0595	4501-0759	4501-0760	4501-0785	4505-0753 ⁸	4501-0309
TRX500 FOREMAN RUBICON 01-04	4501-0597	4501-0759	4501-0760	4501-0785	4505-0658	4501-0309
TRX500 FOREMAN RUBICON 05-06	4501-0596	4501-0759	4501-0760	4501-0785	4505-0644	4501-0309
TRX500 FOREMAN RUBICON 07-08	4501-0596	4501-0759	4501-0760	4501-0785	4505-0632	4501-0309
TRX500 FOREMAN RUBICON 09-14	4501-0596	4501-0759	4501-0760	4501-0785	4505-0632	4501-0309
TRX500 FOREMAN RUBICON 15-18	4501-0595	4501-0759	4501-0760	4501-0785	4505-0633 ⁶	4501-0309
TRX500 FOREMAN RUBICON 15-18	4501-0595	4501-0759	4501-0760	4501-0785	4505-0753 ⁸	4501-0309
TRX650 4X4 RINCON 03-05	4501-0598	4501-0759	4501-0760	4501-0785	4505-0642	4501-0309
TRX680 4X4 RINCON 06-15	4501-0598	4501-0759	4501-0760	4501-0785	4505-0642	4501-0309
BIG RED 09-13	4501-0643	4501-0761	-	-	4505-0687	-
PIONEER 500 15-19	4501-0644	4501-0761	-	-	4505-0693	-
PIONEER 700 / 700-4 14-19	4501-0644	4501-0761	-	-	4505-0688	-
PIONEER 1000-3/1000-5 16-19	4501-0544	4501-0761	-	-	4505-0702 ⁷	-
TALON 1000 19	-	-	-	-	4505-0766	-
JOHN DEERE						
GATOR XUV 550 12-15	4501-0633	4501-0761	-	-	-	-
GATOR XUV 550 16	4501-0654	4501-0761	-	-	4505-0697	-
GATOR XUV 590I 16	4501-0654	4501-0761	-	-	4505-0697	-
GATOR XUV 825I 11-16	4501-0632	4501-0761	-	-	4505-0696	-
GATOR RSX 850I 12-13	4501-0633	4501-0761	-	-	4505-0697	-
KAWASAKI						
KLF250 BAYOU 2X4 02-06	4501-0603	4501-0759	4501-0760	4501-0785	-	4501-0309
KVF300 PRAIRIE 4X4 99-02	M93-62004	4501-0759	4501-0760	4501-0785	-	4501-0309
KVF360 PRAIRIE 4X4 03-11	4501-0601	4501-0759	4501-0760	4501-0785	4505-0646	4501-0309
KLF300 BAYOU 4X4 89-02	4501-0600	4501-0759	4501-0760	4501-0785	-	4501-0309
BRUTE FORCE 300 12-14	-	-	-	-	4505-0674	-
KVF400 PRAIRIE 4X4 97-02	4501-0605	4501-0759	4501-0760	4501-0785	-	4501-0309
BRUTE FORCE 650 (STRAIGHT AXLE) 05	M93-62005	4501-0759	4501-0760	4501-0785	-	4501-0309
BRUTE FORCE 650 (STRAIGHT AXLE) 06-13	M93-62005	4501-0759	4501-0760	4501-0785	4505-0647	4501-0309
BRUTE FORCE 650 (IRS) 06	4501-0608	4501-0759	4501-0760	4501-0785	-	4501-0309
BRUTE FORCE 650 (IRS) 07-09	4501-0608	4501-0759	4501-0760	4501-0785	-	4501-0309
BRUTE FORCE 650 (IRS) 11	4501-0608	4501-0759	4501-0760	4501-0785	4505-0654	4501-0309
KVF650 PRAIRIE 4X4 02-03	M93-62005	4501-0759	4501-0760	4501-0785	4505-0648	4501-0309
KVF700 PRAIRIE 4X4 04-06	M93-62005	4501-0759	4501-0760	4501-0785	4505-0648	4501-0309
KFX700 06-09	4501-0603	4501-0759	4501-0760	4501-0785	-	4501-0309
BRUTE FORCE 750 IRS 4X4 05-18	4501-0608	4501-0759	4501-0760	4501-0785	4505-0654	4501-0309
TERYX 750 08-13	4501-0634	4501-0761	-	-	4505-0678 ³	-
TERYX 750-4 12-14	4501-0634	4501-0761	-	-	4505-0685	-
TERYX 4 800 LE 19	4501-0634	4501-0761	-	-	4505-0685	-
TERYX 800 14-19	4501-0634	4501-0761	-	-	4505-0685	-
MULE 610 05-16	4501-0651	4501-0761	-	-	4505-0677	-
MULE SX 4X4 17	4501-0651	4501-0761	-	-	4505-0677	-
3010 MULE DIESEL 05-06	4501-0194	4501-0761	-	-	4505-0676 ^{1,4}	-
3010 MULE 4-DOOR 07-08	4501-0194	4501-0761	-	-	4505-0676 ^{1,4}	-
3010 MULE 05-08	4501-0194	4501-0761	-	-	4505-0676 ^{1,4}	-
4010 MULE 09-16 (NOT FOR DIESELS)	4501-0194	4501-0761	-	-	4505-0675 ¹	-
4010 MULE TRANS 18	4501-0194	4501-0761	-	-	4505-0675 ¹	-
MULE PRO-FXR 19	4501-0647	4501-0761	-	-	4505-0700	-
MULE PRO-FX 18	4501-0647	4501-0761	-	-	4505-0700	-
MULE PRO-FXT 15-19	4501-0647	4501-0761	-	-	4505-0700	-
KUBOTA						
RTV-X 900 4X4 14	4501-0484	4501-0761	-	-	-	-
RTV X1120 4X4 14	4501-0484	4501-0761	-	-	-	-
KYMCO						
375 MXU 4X4 09	4501-0603	4501-0759	4501-0760	4501-0785	-	4501-0309
500 MXU 4X4 07-08	4501-0602	4501-0759	4501-0760	4501-0785	-	4501-0309
500 MXU 4X4 13	4501-0604	4501-0759	4501-0760	4501-0785	-	4501-0309
700 MXU 4X4 14-15	4501-0604	4501-0759	4501-0760	4501-0785	-	4501-0309
UXVI 450 15	4501-0652	4501-0761	-	-	-	-
UXVI 700 15	4501-0653	4501-0761	-	-	-	-
POLARIS						
XPLORER 250 4X4 00-01	4501-0612	4501-0759	4501-0760	4501-0785	-	4501-0309
XPLORER 300 4X4 96-99	4501-0612	4501-0759	4501-0760	4501-0785	4505-0669	4501-0309
HAWKEYE 300 06	4501-0614	4501-0759	4501-0760	4501-0785	-	4501-0309
SPORTSMAN 300 08	4501-0614	4501-0759	4501-0760	4501-0785	4505-0671	4501-0309
SPORTSMAN 325 ETX 4X4 15	4501-0613	4501-0759	4501-0760	4501-0785	4505-0672	-
MAGNUM 325 4X4 00-01	4501-0612	4501-0759	4501-0760	4501-0785	4505-0669	4501-0309
MAGNUM 325 4X4 02	4501-0609	4501-0759	4501-0760	4501-0785	4505-0669	4501-0309
TRAIL BLAZER 330 08-11	4501-0610	4501-0759	4501-0760	4501-0785	-	4501-0309
TRAIL BOSS 330 08-09	4501-0610	4501-0759	4501-0760	4501-0785	-	4501-0309
TRAIL BOSS 330 05	4501-0612	4501-0759	4501-0760	4501-0785	-	4501-0309
ATP 330 4X4 04	4501-0609	4501-0759	4501-0760	4501-0785	4505-0669	4501-0309
MAGNUM 330 4X4 03-04	4501-0609	4501-0759	4501-0760	4501-0785	4505-0669	4501-0309
MAGNUM 330 2X4 05	4501-0609	4501-0759	4501-0760	4501-0785	-	4501-0309
SPORTSMAN 335 4X4 98-00	4501-0612	4501-0759	4501-0760	4501-0785	4505-0669	4501-0309
SPORTSMAN 400 4X4 94-97	4501-0615	4501-0759	4501-0760	4501-0785	4505-0666	4501-0309
SPORTSMAN 400 4X4 01-03	4501-0612	4501-0759	4501-0760	4501-0785	4505-0669	4501-0309
SPORTSMAN 400 4X4 04	4501-0612	4501-0759	4501-0760	4501-0785	4505-0670	4501-0309
SPORTSMAN 400 4X4 05	4501-0613	4501-0759	4501-0760	4501-0785	4505-0670	4501-0309
SPORTSMAN 400 4X4 08-10	4501-0614	4501-0759	4501-0760	4501-0785	4505-0671	4501-0309
SPORTSMAN 400 4X4 11-14	4501-0613	4501-0759	4501-0760	4501-0785	4505-0672	4501-0309
XPLORER 400L 4X4 95-02 #2907011 & LATER	4501-0612	4501-0759	4501-0760	4501-0785	4505-0669	4501-0309
BIG BOSS 400L 6X6 95-98	4501-0615	4501-0759	4501-0760	4501-0785	4505-0666	4501-0309

FITS MODEL	REQUIRED: BOTTOM MOUNT PART #	REQUIRED: PUSH TUBE FOR WINCH OR ELECTRIC LIFT PART #	REQUIRED: PUSH TUBE FOR UNIVERSAL HAND LIFT PART #	OPTION 1: UNIVERSAL HAND LIFT PART #	OPTION 2: WINCH MOUNT PART #	OPTION 3: ELECTRIC LIFT PART #
POLARIS (CONT)						
XPLORER 400L 4X4 95 #2906001-2907010	4501-0615	4501-0759	4501-0760	4501-0785	4505-0669	4501-0309
XPEDITION 425 4X4 00	4501-0612	4501-0759	4501-0760	4501-0785	4505-0669	4501-0309
MAGNUM 425 4X4 95-98	4501-0615	4501-0759	4501-0760	4501-0785	4505-0666	4501-0309
MAGNUM 425 6X6 95-96	4501-0615	4501-0759	4501-0760	4501-0785	4505-0666	4501-0309
SPORTSMAN 450 16-19	4501-0613	4501-0759	4501-0760	4501-0785	4505-0672	4501-0309
DIESEL 455 4X4 99-00	4501-0612	4501-0759	4501-0760	4501-0785	4505-0669	4501-0309
ATP 500 H.O. 4X4 04-05	4501-0609	4501-0759	4501-0760	4501-0785	4505-0669	4501-0309
SPORTSMAN 500 4X4 96-03	4501-0612	4501-0759	4501-0760	4501-0785	4505-0669	4501-0309
SPORTSMAN 500 4X4 04	4501-0612	4501-0759	4501-0760	4501-0785	4505-0670	4501-0309
SPORTSMAN 500 4X4 05-10	4501-0613	4501-0759	4501-0760	4501-0785	4505-0670	4501-0309
SPORTSMAN 500 4X4 11-13	4501-0613	4501-0759	4501-0760	4501-0785	4505-0672	4501-0309
SPORTSMAN 500 4X4 X2 08	4501-0616	4501-0759	4501-0760	4501-0785	-	4501-0309
SPORTSMAN 500 4X4 X2/TOURING 07-09	4501-0616	4501-0759	4501-0760	4501-0785	4505-0670	4501-0309
SPORTSMAN 500 6X6 00-02	4501-0612	4501-0759	4501-0760	4501-0785	4505-0669	4501-0309
SPORTSMAN 500 6X6 03-08	4501-0610	4501-0759	4501-0760	4501-0785	4505-0669	4501-0309
MAGNUM 500 4X4 99-00	4501-0612	4501-0759	4501-0760	4501-0785	4505-0669	4501-0309
MAGNUM R.M.K. 500 4X4 01	4501-0612	4501-0759	4501-0760	4501-0785	-	4501-0309
BIG BOSS 500 6X6 98-99	4501-0615	4501-0759	4501-0760	4501-0785	4505-0666	4501-0309
XPLORER 500 4X4 97	4501-0612	4501-0759	4501-0760	4501-0785	4505-0669	4501-0309
SPORTSMAN 550 XP 09-14	4501-0611	4501-0759	4501-0760	4501-0785	4505-0672	4501-0309
SPORTSMAN 550 X2/TOURING 10-14	4501-0611	4501-0759	4501-0760	4501-0785	4505-0672	4501-0309
SPORTSMAN 570 4X4 14-19	4501-0613	4501-0759	4501-0760	4501-0785	4505-0672	4501-0309
SPORTSMAN 570 SP/TOURING (ALL) 14-17	4501-0613	4501-0759	4501-0760	4501-0785	4505-0672	4501-0309
SPORTSMAN 600 4X4 03-05	4501-0610	4501-0759	4501-0760	4501-0785	4505-0670	4501-0309
SPORTSMAN 700 4X4 02-07	4501-0610	4501-0759	4501-0760	4501-0785	4505-0670	4501-0309
SPORTSMAN 700 4X4 X2 06-07	4501-0616	4501-0759	4501-0760	4501-0785	-	4501-0309
SPORTSMAN 800 X2 07-09	4501-0616	4501-0759	4501-0760	4501-0785	4505-0670	4501-0309
SPORTSMAN 800 4X4 05-10	4501-0610	4501-0759	4501-0760	4501-0785	4505-0670	4501-0309
SPORTSMAN 800 4X4 11-14	4501-0613	4501-0759	4501-0760	4501-0785	4505-0672	4501-0309
SPORTSMAN 800 TOURING 08	4501-0616	4501-0759	4501-0760	4501-0785	4505-0670	4501-0309
SPORTSMAN 850 XP 09-17	4501-0611	4501-0759	4501-0760	4501-0785	4505-0672	4501-0309
SPORTSMAN 850 XP TOURING 11-16	4501-0611	4501-0759	4501-0760	4501-0785	4505-0672	4501-0309
SCRAMBLER XP 850 13-18	4501-0611	4501-0759	4501-0760	4501-0785	4505-0672	4501-0309
SPORTSMAN 1000 15-18	4501-0611	4501-0759	4501-0760	4501-0785	4505-0672	4501-0309
SCRAMBLER 1000 15-16	4501-0611	4501-0759	4501-0760	4501-0785	4505-0672	4501-0309
RANGER 325 ETX 15	4501-0630	4501-0761	-	-	4505-0692	-
RANGER 400 4X4 10-13	4501-0630	4501-0761	-	-	4505-0692	-
RANGER 500 6X6/4X4 05-08	4501-0630	4501-0761	-	-	4505-0680	-
RANGER 500 4X4 09-10	4501-0636	4501-0761	-	-	4505-0689	-
RANGER 500 4X4 11-13 (INCLUDING CREW MODELS)	4501-0630	4501-0761	-	-	4505-0692	-
RANGER 500 (MIDSIZE) 17-18	4501-0630	4501-0761	-	-	4505-0692	-
RANGER 570 14-19 (MID SIZE)	4501-0630	4501-0761	-	-	4505-0692	-
RANGER 570 15 (FULL SIZE)	4501-0656	4501-0761	-	-	4505-0681	-
RANGER 570 16 (FULL SIZE)	4501-0549	4501-0761	-	-	4505-0692	-
RANGER 570 XP (FULL SIZE) 16	4501-0656	4501-0761	-	-	4505-0681	-
RANGER 700 4X4 (XP) 05-08	4501-0630	4501-0761	-	-	4505-0680	-
RANGER 700 4X4 (XP) 09	4501-0636	4501-0761	-	-	4505-0689	-
RANGER 700 6X6 09	4501-0630	4501-0761	-	-	4505-0680	-
RANGER 800 4X4 10-14 (FULL SIZE)	4501-0636	4501-0761	-	-	4505-0689	-
RANGER 800 4X4 13-14 (MID SIZE)	4501-0630	4501-0761	-	-	4505-0692	-
RANGER 900 XP 13-19	4501-0656	4501-0761	-	-	4505-0681	-
RANGER 900XP CREW 14-18	4501-0656	4501-0761	-	-	4505-0681	-
RANGER DIESEL 11	4501-0636	4501-0761	-	-	4505-0689	-
RZR 570 12-17	4501-0630	4501-0761	-	-	4505-0682 ¹	-
RZR/RZR-S/RZR-4 800 08-14	4501-0630	4501-0761	-	-	4505-0682 ¹	-
RZR 900 XP/ RZR-4 900 11-14	4501-0416	4501-0761	-	-	4505-0458 ¹	-
RZR 900 XP/ RZR-4 900 15-18	4501-0655	4501-0761	-	-	4505-0699	-
RZR 900 XC 16	4501-0655	4501-0761	-	-	-	-
RZR 900 / 900S 15-19	4501-0655	4501-0761	-	-	4505-0699	-
RZR1000 / RZR-4 1000 14-18	4501-0655	4501-0761	-	-	4505-0699	-
GENERAL 1000 16-19	4501-0655	4501-0761	-	-	4505-0699	-
RANGER 1000XP 18	4501-0656	4501-0761	-	-	-	-
RANGER CREW 1000XP 18	4501-0656	4501-0761	-	-	4505-0699	-
RZR 1000 TURBO XP-4 16-17	4501-0655	4501-0761	-	-	-	-
RZR 1000 / RZR-4 1000 14-17	4501-0655	4501-0761	-	-	4505-0699	-
ACE 570 14-18	4501-0617	4501-0761	-	-	4505-0672	-
ACE 900 16	4501-0617	4501-0761	-	-	4505-0672	-
ACE 900 XC 17	4501-0582	4501-0761	-	-	4505-0672	-
SUZUKI						
LT4WD, LT250 90-98	-	-	-	-	4505-0655	-
LT280X/300 KING QUAD 91-98	-	-	-	-	4505-0655	-
QUADRUNNER EIGER MANUAL/AUTO 400 4X4 02-07	4501-0625	4501-0759	4501-0760	4501-0785	4505-0662	4501-0309
KING QUAD 400 08-17	4501-0625	4501-0759	4501-0760	4501-0785	4505-0673	4501-0309
KING QUAD 450 07-09	4501-0622	4501-0759	4501-0760	4501-0785	4505-0656 ³	4501-0309
KING QUAD 500 09-19	4501-0622	4501-0759	4501-0760	4501-0785	4505-0656 ³	4501-0309
LTF 500 QUADRUNNER 98-02	4501-0625	4501-0759	4501-0760	4501-0785	-	4501-0309
QUADRUNNER VINSON 500 MANUAL/AUTO 02-07	4501-0625	4501-0759	4501-0760	4501-0785	4505-0662	4501-0309
TWIN PEAKS 700 04-05	M93-62005	4501-0759	4501-0760	4501-0785	4505-0648	4501-0309
KING QUAD 700 05-07	4501-0622	4501-0759	4501-0760	4501-0785	4505-0656 ³	4501-0309
KING QUAD 750 08-19	4501-0622	4501-0759	4501-0760	4501-0785	4505-0656 ³	4501-0309
TGB						
AVENGER 400 LE QUAD	4501-0622	4501-0475	4501-0760	4501-0785	-	4501-0309
TARGET 400 (4X2)	4501-0622	4501-0475	4501-0760	4501-0785	-	4501-0309
BLADE 425 QUAD	4501-0622	4501-0475	4501-0760	4501-0785	-	4501-0309

PLOWS

FITS MODEL	REQUIRED: BOTTOM MOUNT PART #	REQUIRED: PUSH TUBE FOR WINCH OR ELECTRIC LIFT PART #	REQUIRED: PUSH TUBE FOR UNIVERSAL HAND LIFT PART #	OPTION 1: UNIVERSAL HAND LIFT PART #	OPTION 2: WINCH MOUNT PART #	OPTION 3: ELECTRIC LIFT PART #
TGB (CON'T)						
TARGET 425 (4X4)	4501-0622	4501-0475	4501-0760	4501-0785	-	4501-0309
BLADE 450 SE (4X4)	4501-0622	4501-0475	4501-0760	4501-0785	-	4501-0309
BLADE 460 R TARGET	4501-0622	4501-0475	4501-0760	4501-0785	-	4501-0309
BLADE 460 SL IRS 4X4	4501-0622	4501-0475	4501-0760	4501-0785	-	4501-0309
AVENGER 500 R QUAD	4501-0622	4501-0475	4501-0760	4501-0785	-	4501-0309
TARGET 500 (4X2)	4501-0622	4501-0475	4501-0760	4501-0785	-	4501-0309
BLADE 510 LE	4501-0622	4501-0475	4501-0760	4501-0785	-	4501-0309
BLADE 525 SE 4X4	4501-0622	4501-0475	4501-0760	4501-0785	-	4501-0309
BLADE 525 SL 4X4	4501-0622	4501-0475	4501-0760	4501-0785	-	4501-0309
TARGET 525 (4X4)	4501-0622	4501-0475	4501-0760	4501-0785	-	4501-0309
BLADE 550	4501-0622	4501-0475	4501-0760	4501-0785	-	4501-0309
YAMAHA						
GRIZZLY 350 07-14 (IRS)	4501-0618	4501-0759	4501-0760	4501-0785	4505-0659	4501-0309
GRIZZLY 350 14 (STRAIGHT AXLE)	4501-0618	4501-0759	4501-0760	4501-0785	4505-0659	4501-0309
BRUIN 350 4X4 04-06	4501-0618	4501-0759	4501-0760	4501-0785	4505-0659	4501-0309
WOLVERINE 350 4X4 95-05	M93-64005	4501-0759	4501-0760	4501-0785	4505-0665	4501-0309
WOLVERINE 350 4X4 07-09	4501-0618	4501-0759	4501-0760	4501-0785	4505-0660	4501-0309
BIG BEAR 350 4X4 94-96	4501-0619	4501-0759	4501-0760	4501-0785	-	4501-0309
BIG BEAR 350 4X4 97-99	M93-64005	4501-0759	4501-0760	4501-0785	-	4501-0309
YFM400 BIG BEAR 4X4 00-06	M93-64005	4501-0759	4501-0760	4501-0785	4505-0651	4501-0309
YFM400 KODIAK FWT 93-98	4501-0619	4501-0759	4501-0760	4501-0785	-	4501-0309
KODIAK 400 99	M93-64005	4501-0759	4501-0760	4501-0785	-	4501-0309
KODIAK 400 ULTRAMATIC 00-02	4501-0618	4501-0759	4501-0760	4501-0785	4505-0650	4501-0309
KODIAK 400 4X4 03-05	4501-0618	4501-0759	4501-0760	4501-0785	4505-0659	4501-0309
GRIZZLY 450 07-08	4501-0618	4501-0759	4501-0760	4501-0785	4505-0659	4501-0309
GRIZZLY 450 09-14	4501-0618	4501-0759	4501-0760	4501-0785	4505-0637 ²	4501-0309
KODIAK 450 4X4 & AUTO 03-06	4501-0618	4501-0759	4501-0760	4501-0785	4505-0659	4501-0309
KODIAK 450 18	4501-0628	4501-0759	4501-0760	4501-0785	-	4501-0309
WOLVERINE 450 06-10	4501-0618	4501-0759	4501-0760	4501-0785	4505-0660	4501-0309
GRIZZLY 550 09-15	4501-0623	4501-0759	4501-0760	4501-0785	4505-0653	4501-0309
GRIZZLY 600 98-01	M93-64004	4501-0759	4501-0760	4501-0785	4505-0649	4501-0309
GRIZZLY 660 02-08	4501-0623	4501-0759	4501-0760	4501-0785	4505-0652	4501-0309
GRIZZLY 700 EPI 07-15	4501-0623	4501-0759	4501-0760	4501-0785	4505-0653	4501-0309
GRIZZLY 700 16-18	4501-0623	4501-0759	4501-0760	4501-0785	4505-0634	4501-0309
KODIAK 700 16-17	4501-0623	4501-0759	4501-0760	4501-0785	4505-0634	4501-0309
RHINO 450 06-09	4501-0634	4501-0761	-	-	4505-0679	-
RHINO 660 06-07	4501-0634	4501-0761	-	-	4505-0679	-
RHINO 700 08-13	4501-0634	4501-0761	-	-	4505-0679	-
VIKING 700 14-18	4501-0639	4501-0761	-	-	4505-0529	-
VIKING 700 6 SEATER 14-17	4501-0639	4501-0761	-	-	4505-0529	-
WOLVERINE 700 16-17	4501-0638	4501-0761	-	-	4505-0580	-
WOLVERINE X2 / X2 R-SPEC / X4 S.E. 18-19	4501-0832	4501-0761	-	-	4505-0746	-
WOLVERINE / R-SPEC 18	4501-0832	4501-0761	-	-	4505-0580	-

¹ WILL NOT WORK WITH WARN OR MOOSE UTILITY DIVISION® 4000 LB. WINCH ² WILL NOT WORK WITH MOOSE UTILITY DIVISION® 3700 LB. WINCH OR SUPERWINCH TERRA SERIES
³ WORKS ONLY WITH WARN 2,500, 3,000 AND 4000 LB. WINCHES ⁴ ONLY FOR TWO-BOLT MOUNT STYLE WINCHES ⁵ MUST USE MOOSE UTILITY DIVISION® ROLLER FAIRLEAD PART #4505-0704
⁶ WILL NOT WORK WITH TWO-BOLT WINCHES ⁷ WORKS ONLY WITH 4000 LB. WINCH ⁸ IF USING MOOSE UTILITY DIVISION® VRX WINCHES, 2500/3500

PLOW REPLACEMENT PARTS

Made in the USA.

DESCRIPTION	QTY	PART #
REPLACEMENT BOTTOM MOUNT U-BOLTS		
7,9 MM (5/16") X 28,6 MM (1-1/8") X 57 MM (2-1/4") U-BOLT (SQUARE U-BOLT)	4	4501-0682
7,9 MM (5/16") X 31,8 MM (1-1/4") X 70 MM (2-3/4") U-BOLT	4	4501-0688
7,9 MM (5/16") X 35 MM (1-3/8") X 55,5 MM (2-3/16") U-BOLT	4	4501-0689
7,9 MM (5/16") X 57 MM (2-1/4") X 108 MM (4-1/4") U-BOLT (SQUARE U-BOLT)	4	4501-0690
7,9 MM (5/16") X 31,8 MM (1-1/4") X 57 MM (2-1/4") U-BOLT (SQUARE U-BOLT)	4	4501-0829
7,9 MM (5/16") X 38 MM (1-1/2") X 89 MM (3-1/2") U-BOLT (SQUARE U-BOLT)	4	4501-0696
7,9 MM (5/16") X 50,8 MM (2") X 76 MM (3") U-BOLT (SQUARE U-BOLT)	4	4501-0697
7,9 MM (5/16") NYLOCK NUT	48	4501-0687
BLADE PARTS		
BLADE SPRINGS	PR	4501-0828
BLADE STOP KIT	PR	4501-0830
9,5 MM (3/8") NYLOCK NUT	20	4501-0686
BOTTOM MOUNT PINS		
WIRE LOOP PINS (SHORT NEW STYLE)	2	4501-0015
WIRE LOOP PINS (LONG OLD STYLE)	2	4501-0674
BLADE SKIDS & RELATED PARTS		
SKID LYNCH PIN	4	4501-0092
RUBBER SKID WASHERS	8	4501-0683
HEAVY DUTY SKID - SCREW IN STYLE	EA	4501-0703
REPLACEMENT SKID - NON SCREW IN STYLE	EA	4501-0702
PLOW SKID CONVERSION KIT	KT	4501-0579
PLOW SKID BRACKETS	2	4501-0698
15,9 MM (5/8") FLAT WASHERS	18	4501-0223
PUSH TUBE PARTS		
BLADE POSITION PIN SPRING	4	4501-0684
SHOULDER/PIVOT BOLT OLD STYLE	EA	4501-0814
BLADE POSITION ASSEMBLY	EA	4501-0794
9,5 MM (3/8") X 19,1 MM (3/4") SHOULDER BOLT	4	4501-0681
12,7 MM (1/2") X 25,4 MM (1") SHOULDER BOLT	4	4501-0088

DESCRIPTION	QTY	PART #
PUSH TUBE PARTS (CON'T)		
12,7 MM (1/2") WASHER	20	4501-0685
9,5 MM (3/8") NYLOCK NUT	20	4501-0686
BLADE SWIVEL	EA	4501-0673
REPL. PUSH TUBE ONLY ATV	EA	4501-0833
REPL. PUSH TUBE ONLY UTV	EA	4501-0834
WEAR BAR PARTS		
7,9 MM (5/16") X 25,4 MM (1") CARRIAGE BOLT AND 7,9 MM (5/16") WHIZ NUT	7	4501-0691
UNIVERSAL MANUAL LIFT PARTS		
MANUAL LIFT REPLACEMENT STRAP	EA	4501-0694
AXLE CAPS FOR MANUAL LIFT	EA	4501-0695
ELECTRIC LIFT PARTS		
RELAY WIRING SYSTEM	EA	4501-0009
SWITCH WIRING SYSTEM	EA	4501-0112
RELAY	EA	M91-80094
STRAP	EA	4501-0011
RM4 PARTS		
PULLEY KIT	EA	4501-0699
PULLEY REPLACEMENTS	EA	4501-0701
RM4 HITCH PINS	2PK	4501-0700
REPLACEMENT REMOVABLE MOUNT ATV	EA	4501-0799
REPLACEMENT REMOVABLE MOUNT UTV	EA	4501-0800
PULLEY KIT		
REPLACEMENT PULLEY	2PK	4501-0701
(OLD) HYDRAULIC REPLACEMENT PART		
REPL. V-PLOW HAND CONTROL	EA	4501-0465
HYDRAULIC PUMP	EA	4501-0466
HYDRAULIC CYLINDER	EA	4501-0468
V-PLOW CENTER BLADE SKID	EA	4501-0464



BEACON WARNING LIGHT

16 solid state LEDs provide 360 degree rotational pattern. High visibility no scratch yellow housing. Magnet mounting. 12V DC power with on/off button. Dimensions: 108 mm (4 1/4") D x 32 mm (1 1/4") H. Works great with our Extension Pole 2040-1273 (sold separately).

DESCRIPTION	PART #
BEACON WARNING LIGHT	2040-2447
EXTENSION POLE	2040-1273



PLOW LIGHT MOUNT KIT

Base made from steel. Light support arms made from 7-gauge steel. Great for night time, or early morning plowing. Attaches to front rack of ATV. Uses 29 mm (1 1/8") u-bolts. Made in the USA.

DESCRIPTION	PART #
PLOW LIGHT MOUNT KIT	2001-0116



40,5 CM (16") PLOW MARKERS

Clearly marks plow edges for increased visibility and safety. Durable hard rubber; sold in pairs. Made in the USA.

DESCRIPTION	PART #
40,5 CM (16") PLOW MARKERS	4501-0835

PLOWS



STEEL REPLACEMENT WEAR BARS

Available in 76 mm (3") heavy-duty design. Comes standard on all plows. Reversible for longer life. Replacement nuts/bolts sold separately on page 16. Made in the USA.

DESCRIPTION	PART #	STYLE
107 CM (42") BLADE	4501-0661	GLOSS BLACK
107 CM (42") BLADE	4501-0779	MATTE BLACK
127 CM (50") BLADE	4501-0662	GLOSS BLACK
127 CM (50") BLADE	4501-0780	MATTE BLACK
140 CM (55") BLADE	4501-0663	GLOSS BLACK
140 CM (55") BLADE	4501-0781	MATTE BLACK
152 CM (60") BLADE	4501-0664	GLOSS BLACK
152 CM (60") BLADE	4501-0782	MATTE BLACK
168 CM (66") BLADE (2-PIECE 84 CM (33"))	4501-0585	GLOSS BLACK
168 CM (66") BLADE (2-PIECE 84 CM (33"))	4501-0783	MATTE BLACK
183 CM (72") BLADE (2-PIECE 91 CM (36"))	4501-0666	GLOSS BLACK
183 CM (72") BLADE (2-PIECE 91 CM (36"))	4501-0784	MATTE BLACK
V-PLOW BLADE (1 SIDE-91 CM (36"))	4501-0669	GLOSS BLACK
152 CM (60") CYCLE COUNTRY BLADE	4501-0672	GLOSS BLACK



PLASTIC REPLACEMENT WEAR BARS

16 mm (5/8") thick and provide softer impact than steel. Great for paver/stone driveways. Ultra High Molecular Weight plastic (UHMW) construction. Reversible, just flip when worn. Requires longer bolts; available in bolt kit. Made in the USA.

DESCRIPTION	PART #
FITS ALL 127 CM (50") BLADES	4501-0318
UNIVERSAL 127 CM (50") / NO HOLES / DRILL HOLES CUT DOWN FOR SMALLER BLADES	4501-0463
FITS ALL 140 CM (55") BLADES	4501-0319
FITS ALL 152 CM (60") BLADES	4501-0320
UNIVERSAL 152 CM (60") / NO HOLES / DRILL HOLES CUT DOWN FOR SMALLER BLADES	4501-0321
FITS ALL 168 CM (66") BLADES	4501-0592
FITS ALL 183 CM (72") BLADES (2 PIECES-91 CM (36") EACH)	4501-0462
BOLT KIT / 7 BOLTS AND NUTS	4501-0693

SHOCK SPRING WEDGES

Installs in minutes and offers additional front or rear suspension stiffness while using items such as snow plows, sprayers, and spreaders. Fits most utility ATV stock shocks with spring diameter up to 76 mm (3"). Sold in pairs. Made in the USA.



DESCRIPTION	PART #
SHOCK SPRING WEDGES	0431-0260



RUBBER PLOW FLAP

Increases your control of airborne snow while plowing. Comes standard on all County Blades and 168 cm / 183 cm (66"/72") Standard Blades. Made in the USA.

DESCRIPTION	PART #
127 CM (50") BLADE	4501-0676
140 CM (55") BLADE	4501-0677
152 CM (60") BLADE	4501-0678
168 CM (66") BLADE	4501-0768
183 CM (72") BLADE	4501-0679

PLOW SIDE SHIELDS

Attaches to the forward end of an angled plow blade to greatly reduce the amount of overflowing snow or dirt. Install on either side or both sides of a Standard Plow blade to contain more plowed material. Works only on smaller side of County Plow blade. Some drilling is required. Measures 38 cm (15") H x 25,5 cm (10") D. Sold as each. Made in the U.S.A.

DESCRIPTION	PART #
RIGHT SIDE	4501-0774
LEFT SIDE	4501-0775



PULLEY KIT

Recommended to use with all RM4 plow kits. Eases lifting the plow, extends winch cable life and provides smooth operation. Simple installation bolts on top of the position pin assembly. Strong steel powdercoated brackets work with all RM4 and standard plow systems. Features a roller bearing for consistent, smooth operation. Adjustable nylon attachment strap prevents scratching. All hardware and instructions included. Made in the USA.

DESCRIPTION	PART #
PULLEY KIT	4501-0699



REPLACEMENT BLADE SKIDS

Made in the USA.

DESCRIPTION	PART #
PLOW SKID (NEW STYLE)	4501-0702
CONVERSION KIT FOR NEW SKIDS	4501-0579
SCREW IN STYLE (OLD STYLE)	4501-0703



CABLE REPL. RM4 UTV

Release mechanism cable for the RM4 plow frame.

DESCRIPTION	PART #
CABLE REPL. RM4 UTV	4510-1242





4501-0759



4501-0761

ATV/UTV PUSH TUBE

Increases ground clearance. Blade swivel constructed of 9,5 mm (3/8") steel. Strong matte, powder coated finish. Five blade swivel positions and four-way blade pitch adjustment. Made in the USA.

DESCRIPTION	PART #
ATV PUSH TUBES FOR USE W/ WINCH OR ELECTRIC LIFT 117 CM (46") L	4501-0759
ATV PUSH TUBES FOR USE W/ UNIVERSAL HAND LIFT 117 CM (46") L	4501-0760
UTV PUSH TUBES FOR USE W/ WINCH 117 CM (46") L	4501-0761
UNIVERSAL PUSH TUBE FOR UTVS W/ TRACK SYSTEMS 147 CM (46") L	4501-0762
REPLACEMENT PUSH TUBE ONLY (ATV)	4501-0833
REPLACEMENT PUSH TUBE ONLY (UTV)	4501-0834

ATV/UTV BOTTOM MOUNT

Quick-connect mounting hardware for easy hook-up and fast removal. Includes all necessary hardware to attach universal push tube and plow. Provides more ground clearance when plow blade is removed. Made in the USA.



DESCRIPTION	PART #
ATV/UTV BOTTOM MOUNT	APPLICATION CHART ON PGS 12-16

UNIVERSAL ATV BOTTOM MOUNT

Will fit most ATVs with standard tubular frames. Multiple mounting configurations. Includes a variety of u-bolts to fit over most frame tubes. 7-gauge steel construction. Black powdercoat finish. Made in the USA.



DESCRIPTION	PART #
UNIVERSAL ATV BOTTOM MOUNT	4501-0629

PUSH TUBE CONVERSION KIT

Converts old-style push tubes for use with extended lift system bottom mount kits. Made in the USA.



DESCRIPTION	PART #
PUSH TUBE CONVERSION KIT	4501-0675



ATV/UTV WINCH MOUNT KIT

Winch mount kits accept Warn®, Superwinch® and all Moose Utility Division® winches. Made in the USA.

DESCRIPTION	PART #
ATV/UTV WINCH MOUNT KIT	APPLICATION CHART ON PGS 12-16



UNIVERSAL HAND LIFT

Length of the overall swing on the lift handle reduced for easier lift/lower. Simple bolt on installation to all 4501-0477 push tubes. Capable of lifting up to 30,5 cm (12") off the ground. Universal fit for all ATVs. Made in the USA.

DESCRIPTION	PART #
UNIVERSAL HAND LIFT	4501-0785



ELECTRIC PLOW LIFT

Lifts the plow without the need or use of a winch. Screw-drive system runs at optimum speed; has plenty of lifting power and low amp draw. Compact design fits all plow systems new or old except the RM4. Includes wiring, hardware and all-weather handlebar mounted switch. Made in the USA.

DESCRIPTION	PART #
ELECTRIC PLOW LIFT	4501-0309





PLOWS

WINCHES

UTV

RACKS

IMPLEMENTS
& TOWING

LUGGAGE

BODY

CONTROLS

ELECTRICAL

WHEELS
& TIRES

SUSPENSION
& DRIVE

BRAKING

ENGINE

RIDER

GARAGE

PROMO

WINCHES



4500 LB UTV WINCH

4500 lb capacity. For UTVs only. Durable all metal construction. Includes dash mounted control switch and corded remote control. Load holding brake for great control. Smooth and reliable, all metal three stage planetary gear train. Available in both wire rope and synthetic rope. Wire and synthetic are both 50' x 1/4". Made in the USA.

DESCRIPTION	PART #
4500 LB WITH WIRE ROPE	4505-0724
4500 LB WITH SYNTHETIC ROPE	4505-0725

3500 LB WINCH

3500 lb capacity. Perfect for ATVs or smaller UTVs. Durable all metal construction. Load holding mechanical brake for great control. Smooth and reliable all metal three stage planetary gear train. Available in both wire rope and synthetic rope. Wire and synthetic are both 50' x 7/32". Made in the USA.

DESCRIPTION	PART #
3500 LB WITH WIRE ROPE	4505-0722
3500 LB WITH SYNTHETIC ROPE	4505-0723



2500 LB WINCH

2500 lb capacity. Great for smaller ATVs. Durable all metal construction. Load holding mechanical brake for great control. Smooth and reliable all metal three stage planetary gear train. Available in both wire rope and synthetic rope. Wire and synthetic are both 50' x 3/16". Made in the USA.

DESCRIPTION	PART #
2500 LB WITH WIRE ROPE	4505-0720
2500 LB WITH SYNTHETIC ROPE	4505-0721

WINCH REPLACEMENT PARTS

OLD WINCH PART #	DESCRIPTION	ROPE PART #	CONTACTOR PART #	ROCKER SWITCH PART #	REPLACEMENT WINCH CORES PART #	WINCH HOUSING ASSEMBLY PART #
4505-0017	1,700LB W/ WIRE ROPE	4505-0233	-	4505-0232	-	4505-0231
4505-0479	2000LB VANTAGE W/ WIRE ROPE	4505-0233	4505-0512	-	4505-0547	-
4505-0480	2000LB VANTAGE W/ SYNTHETIC ROPE	4505-0213	4505-0512	-	4505-0547	-
4505-0481	3000LB VANTAGE W/ WIRE ROPE	-	4505-0513	-	4505-0547	-
4505-0482	3000LB VANTAGE W/ SYNTHETIC ROPE	4505-0212	4505-0513	-	4505-0547	-
4505-0483	4000LB VANTAGE W/ WIRE ROPE	4505-0438	4505-0513	4505-0514	4505-0548	-
4505-0484	4000LB VANTAGE W/ SYNTHETIC ROPE	4505-0439	4505-0513	4505-0514	4505-0548	-
4505-0720	2500LB VRX W/ WIRE ROPE	4505-0728	-	-	-	-
4505-0721	2500LB VRX W/ SYNTHETIC ROPE	4505-0729	-	-	-	-
4505-0722	3500LB VRX W/ WIRE ROPE	4505-0727	-	-	-	-
4505-0723	3500LB VRX W/ SYNTHETIC ROPE	4505-0726	-	-	-	-
4505-0725	4500LB VRX W/ SYNTHETIC ROPE	4505-0726	-	-	-	-



WINCHES



RECEIVER STYLE WINCH CRADLES

Universal receiver mounted winch cradle fits almost any ATV or UTV with a 51 mm (2") or 32 mm (1 1/4") receiver hitch. Mount any 2-or-4 bolt pattern winch up to 4500 lb. Even accepts wide drum winches! Includes hardware and mounting pin/clip. Formed steel construction has built in handles and features a durable powder coat finish. Quick disconnect plugs are included for a truly plug and play setup. Made in the USA.

DESCRIPTION	PART #
51 MM (2") RECEIVERS	4505-0624
32 MM (1-1/4") RECEIVERS	4505-0625



ROLLER FAIRLEAD

Designed to reduce cable wear, especially on sharp angle pulls. Made in the USA.

DESCRIPTION	PART #
ROLLER FAIRLEAD	4505-0704



LARGE ROLLER FAIRLEAD

Designed for use with winches that primarily raise and lower the ATV plow blade. Larger diameter lower roller reduces wear on rope.

DESCRIPTION	PART #
LARGE ROLLER FAIRLEAD W/ METAL ROLLERS	4505-0621
LARGE ROLLER FAIRLEAD W/ PLASTIC ROLLERS	4505-0622



PLOW FAIRLEAD PULLEY BRACKET

For use with standard size winches with a 12.5 cm (4.875") bolt-up pattern. Replaces standard winch fairlead during plow season. Roller has a curved cable groove to help eliminate cable flattening, which leads to snapped cables during the plowing season. Multiple roller positions for different applications and cable angles. For steel cable use only.

DESCRIPTION	PART #
PLOW FAIRLEAD PULLEY BRACKET	4505-0731

DASH ROCKER SWITCH W/ WIRING

Illuminated switch to operate the winch. Dash-mounted. Wiring harness included for quick, easy installation. For use on 2000, 3000 and 4000 lb winches

DESCRIPTION	PART #
DASH ROCKER SWITCH W/ WIRING	4505-0606





RUBBER CABLE STOP

Impact-absorbing rubber prevents bottoming-out of winch. Prevents hook rattling when not in use. A must have for preventing minor damage.

DESCRIPTION	PART #
RUBBER CABLE STOP	4505-0475



SYNTHETIC WINCH ROPE

Eliminate wire slivers and extra weight. Synthetic winch cable is safer than traditional wire cable. For aluminum drum winches. Tubular abrasion protector extends rope life. Soft eyelet on working end to easily thread through snatch blocks. 6 mm ropes are recommended for UTVs. 4000 lb working load.

COLOR	THICKNESS	DIAMETER	LENGTH	PART #
BLUE	5MM	3/16	127 CM (50')	4505-0611
RED	5MM	3/16	127 CM (50')	4505-0612
YELLOW	5MM	3/16	127 CM (50')	4505-0613
GREEN	5MM	3/16	127 CM (50')	4505-0614
BLACK	5MM	3/16	127 CM (50')	4505-0615
GREY	5MM	3/16	127 CM (50')	4505-0343
BLUE	6MM	1/4	127 CM (50')	4505-0616
RED	6MM	1/4	127 CM (50')	4505-0617
YELLOW	6MM	1/4	127 CM (50')	4505-0618
GREEN	6MM	1/4	127 CM (50')	4505-0619
BLACK	6MM	1/4	127 CM (50')	4505-0620



TREE AND CABLE SAVER WINCH STRAP

Protects trees from damage and cable gouging. Extends cable life and saves cable from fraying. 51 mm (2") wide x 183 cm (6') long synthetic webbing. Handy and easy to use. 2667 lbs safe work load. 8000 lbs break strength.

DESCRIPTION	PART #
TREE AND CABLE SAVER WINCH STRAP	3920-0397



SNOW PLOW STRAP

For use with standard or wide winches. Recommended to be used with roller fairlead. Replaces a steel/synthetic line during plow season. 19.5 m (64') of overall length and features 38 mm (1 1/2") wide heavy-duty strap and 8 mm (5/16") synthetic attachment line. Use your existing winch hook. Multiple spool attachment options. Maximizes winch pulling capacity and eliminates damage to winch by avoiding cable stacking and binding. Reduces wear on fairleads.

DESCRIPTION	PART #
SNOW PLOW STRAP	4505-0607







FULL CAB ENCLOSURES

Water resistant shell with automotive grade clear flexible acrylic windshield, doors and back window. Doors are completely removable and have full length double pull zippers. Cab comes with self adhesive hook and loop closures and installation/care instructions. 40 oz Tonneau-Tex™ vinyl material. Made in the USA.

FITS MODEL	PART #
ARCTIC CAT	
PROWLER 06-08 (BLACK)	0521-0561
KAWASAKI	
MULE 610 ALL YEARS (BLACK)	0521-0282
MULE 3000 SERIES (BLACK)	MUDKM-104
POLARIS	
RZR 800 ALL YEARS (BLACK)	0521-0569
YAMAHA	
RHINO 04-11 (BLACK)	4510-0001
RHINO 04-11 W/ OEM DOORS (BLACK)	0521-0669



BENCH AND BUCKET SEAT COVERS

Made from 500-denier Cordura®. Protects the seat from punctures and daily wear. Comes with headrests for specific applications. Yamaha Rhino covers are made of 3 mm black neoprene. Made in the USA.

FITS MODEL	PART #
CAN-AM	
DEFENDER (BLACK)	0821-2650
HONDA	
PIONEER 1000 (BLACK)	0821-2654
KAWASAKI	
MULE 2500/3000/4000 SERIES (BLACK)	MUDKM124
MULE PRO FX (BLACK)	0821-2656
MULE PRO FXT (BLACK)	0821-2658
POLARIS	
FULL SIZE RANGER 02-08 (BLACK)	MUDPR112
FULL SIZE RANGER 09-13 (BLACK)	0821-0995
MID SIZE RANGER 12-14 (BLACK)	0821-1843
RANGER 900XP 13-15 (BLACK)	0821-1778 ¹
RANGER 900XP CREW (BLACK)	0821-2660 ³
GENERAL (BLACK)	0821-2652
YAMAHA	
RHINO 04-11 (BLACK)	0821-0710 ²
VIKING 15-16 (BLACK)	0821-2249
VIKING VI (BLACK)	0821-2662

¹ ONLY FOR 60/40 BACK RESTS

² NEOPRENE SEAT COVERS

³ ONLY FOR FIVE SEAT W/ CENTER CONSOLE



FULL SIZE DOORS WITH INTEGRATED REAR PANEL

Sturdy 19,1 mm (3/4") tubular steel frame and door latch. Durable UV resistant, PVC coated heavyweight nylon covers. Entire doors come of in seconds, no tools required. Upper door covers are easily removable for ventilation. Easy installation with Quickfit strapping system; no drilling required which doesn't void any OEM warranties. Extra window on the bottom half of the doors for added visibility. Tight all around seal resists water and wind intrusion into the cab. Rear window panel provides weather protection and great rear visibility. Shown with 0521-0994 roof (page 34).

FITS MODEL	PART#
POLARIS	
FULL SIZE POLARIS RANGER 09-14 (ROUND TUBE)	0521-1042 ¹
YAMAHA	
VIKING 700 15-18	0521-1420

¹ NOT FOR 13-16 RANGER 900 XP.



REAR DUST PANELS

Multiple straps allow the dust panel to work with most hardtops. Large vinyl window. Constructed from heavy-duty rip stop nylon. Easy installation and removal.

FITS MODEL	PART #
CAN-AM	
COMMANDER/MAVERICK (ALL)	0521-1444
HONDA	
PIONEER 700 (ALL)	0521-1516
PIONEER 1000 (ALL)	0521-1515
KAWASAKI	
MULE PRO FXT	0521-1517
MULE PRO FX	0521-1518
MULE 610 (ALL)	0521-1752
TERYX 2 14-17	0521-1440
TERYX 4 14-17	0521-1441
POLARIS	
RANGER 400/500 09-14 (MIDSIZE)	0521-0944
RANGER 700/800 09-14 (FULLSIZE)	0521-0943
RZR 800 08-14	0521-0945
RZR/RZR S 15-16 (ALL)	0521-1442
RANGER 900 XP 14-18	0521-1443
RANGER 900 CREW (ALL)	0521-1519
GENERAL (ALL)	0521-1514
YAMAHA	
VIKING (ALL)	0521-1421
VIKING VI (ALL)	0521-1520
YZZ1000 (ALL)	0521-1753



0521-1043

SOFT TOPS WITH INTEGRATED REAR PANEL

Durable UV resistant, PVC coated denier nylon. Vehicle specific design for a great fit. Secures to windshields with adhesive backed hook and loop closures. Easily installs without tools and drilling. Uses Quickfit tightening system to create a super tight fit with no loose flaps. Rear panel can be rolled and strapped up for ventilation.

FITS MODEL	PART #
POLARIS	
MIDSIZE POLARIS RANGER 400/500 09-14	0521-1043
FULLSIZE POLARIS RANGER 700/800 09-14	0521-1044
YAMAHA	
RHINO (ALL)	0521-1045



BACK PANELS

Made from 4,5 mm (0.177") thick, clear polycarbonate. Adds a finished look to your UTV and keeps debris from entering the cab. Comes with all mounting hardware. Made in the USA.

FITS MODEL	PART #	OVERALL WIDTH	OVERALL HEIGHT
KAWASAKI			
MULE 600, 610, SX 05-19	0521-1721	118 CM (46.5")	61,5 CM (24.25")
POLARIS			
RANGER 570 FULL-SIZE 15	0521-1722	137 CM (54")	52 CM (20.5")
GENERAL 16-19	0521-1720	137 CM (54")	23,5 CM (21")
RANGER XP 1000 16-19	0521-1722	137 CM (54")	52 CM (20.5")
RANGER XP 900 13-19	0521-1722	137 CM (54")	52 CM (20.5")
RANGER DIESEL 15-19	0521-1722	137 CM (54")	52 CM (20.5")
RANGER DIESEL HST 15-19	0521-1722	137 CM (54")	52 CM (20.5")
RZR XP4 14-19	0521-1723	121 CM (47.75")	64 CM (25.25")
RANGER MID-SIZE 400, 500, 800, EV 11-14	0521-1257	131 CM (51.62")	67,5 CM (26.62")

UTILITY VEHICLE



FULL FOLDING WINDSHIELDS

Premium .177" thick clear polycarbonate shield. Centrally hinged for ventilation. Tool-less operation. Stainless steel rubber coated mount straps. Rubber seal helps keep elements out. Replacement kit (Part # 2317-0164) with 6" rubber seal available separately. Made in the USA.

FITS MODEL	FULL FOLDING PART #	OVERALL WIDTH	OVERALL HEIGHT	REPL. RUBBER STRAPS PART #	REPL. HARDWARE PART #
ARCTIC CAT					
PROWLERS 11-12 (ROUND TUBING)	2317-0180	135 CM (53.13")	77,5 CM (30.51")	2317-0258	2317-0260
HAVOC 18-19	2317-0433	125,5 CM (49.47")	59 CM (23.14")	2317-0258	2317-0260
STAMPEDE 18-19	2317-0433	125,5 CM (49.47")	59 CM (23.14")	2317-0258	2317-0260
CAN-AM					
COMMANDER (ALL) 11-18	2317-0181	132 CM (52.05")	81,5 (32.02")	2317-0258	2317-0259
MAVERICK 1000 14-18	2317-0300	132,5 CM (52.18")	66 CM (26.00")	2317-0258	2317-0259
DEFENDER 16-18	2317-0360	130,5 CM (51.37")	83 CM (32.75")	2317-0258	2317-0259
MAVERICK X3 17-19	2317-0432	124 CM (48.75")	72,5 CM (28.48")	2317-0258	2317-0259
CF MOTO					
U FORCE-ALL	2317-0329	125 CM (49.19")	58,5 CM (23.11")	2317-0258	2317-0260
Z FORCE-ALL	2317-0330	106,5 CM (41.87")	57,5 CM (22.57")	2317-0258	2317-0260
HONDA					
BIG RED 09-14	2317-0182 ¹	150,5 CM (59.25")	56,5 CM (22.23")	2317-0258	2317-0260
PIONEER 500 15-19	2317-0297	109 CM (42.94")	73,5 CM (28.87")	2317-0258	2317-0260
PIONEER 1000 / 5 15-19	2317-0356	136 CM (53.50")	65 CM (25.53")	2317-0258	2317-0260
KAWASAKI					
MULE 3010 00-08	2317-0183 ²	137 CM (54.00")	90,5 CM (35.62")	2317-0258	2317-0260
MULE 4010 09-19	2317-0184 ²	135 CM (53.00")	78,5 CM (30.91")	2317-0258	2317-0260
TERYX 750 10-13	2317-0185	122 CM (48.00")	67 CM (26.68")	2317-0258	2317-0260
TERYX 800 14-15	2317-0186	139,5 CM (54.94")	68,5 CM (26.93")	2317-0258	2317-0260
TERYX 800 16-19	2317-0357	140,5 CM (55.23")	56,5 CM (22.27")	2317-0258	2317-0260
TERYX 4 12-15	2317-0186	139,5 CM (54.94")	68,5 CM (26.93")	2317-0258	2317-0260
TERYX 4 16-19	2317-0357	140,5 CM (55.23")	56,5 CM (22.27")	2317-0258	2317-0260
MULE PRO-FXT 15-19	2317-0298	148 CM (58.25")	77,5 CM (30.56")	2317-0258	2317-0260
KYMC0					
XUV 500 / 700 ALL	2317-0301	137 CM (54.00")	62,5 CM (24.56")	2317-0258	2317-0260
POLARIS					
RANGER 400 (MID SIZE) 14	2317-0189	119,5 CM (47.12")	75 CM (29.44")	2317-0258	2317-0260
RANGER 400/500 ALL MODELS (MID SIZE) 09-14	2317-0189	119,5 CM (47.12")	75 CM (29.44")	2317-0258	2317-0260
RANGER 500 (MID SIZE) 15-19	2317-0299	114,5 CM (45.12")	68,5 CM (26.89")	2317-0258	2317-0261
RANGER 500 CREW 09	2317-0187	149 CM (58.75")	86 CM (33.93")	2317-0258	2317-0260

FITS MODEL	FULL FOLDING PART #	OVERALL WIDTH	OVERALL HEIGHT	REPL. RUBBER STRAPS PART #	REPL. HARDWARE PART #
POLARIS (CON'T)					
ACE 570 14-17	2317-0302	74,5 CM (29.29")	56 CM (22.08")	2317-0258	2317-0260
RANGER 570 (FULL SIZE) 15	2317-0176	127,5 CM (50.13")	75 CM (29.61")	2317-0258	2317-0261
RANGER 570 (MID SIZE) 15-19	2317-0299	114,5 CM (45.12")	68,5 CM (26.89")	2317-0258	2317-0261
RANGER CREW 570 (FULL SIZE) 15	2317-0176	127,5 CM (50.13")	75 CM (29.61")	2317-0258	2317-0261
RANGER 570 (MID SIZE) 14	2317-0189	119,5 CM (47.12")	75 CM (29.44")	2317-0258	2317-0260
RANGER CREW 570 (MID SIZE) 15-19	2317-0299	114,5 CM (45.12")	68,5 CM (26.89")	2317-0258	2317-0261
RANGER CREW 570 (FULL SIZE) 16-19	2317-0188	134,5 CM (52.88")	81,5 CM (32.16")	2317-0258	2317-0260
RANGER 700/800 08	2317-0187	149 CM (58.75")	86 CM (33.93")	2317-0258	2317-0260
RANGER 700/800 09-14	2317-0188	134,5 CM (52.88")	81,5 CM (32.16")	2317-0258	2317-0260
RANGER 700/800 CREW/6X6 10-14	2317-0188	134,5 CM (52.88")	81,5 CM (32.16")	2317-0258	2317-0260
RANGER 800 (FULL SIZE) 14	2317-0188	134,5 CM (52.88")	81,5 CM (32.16")	2317-0258	2317-0260
RANGER 800 (MID SIZE) 14	2317-0189	119,5 CM (47.12")	75 CM (29.44")	2317-0258	2317-0260
RANGER 800 6X6 (FULL SIZE) 14-16	2317-0188	134,5 CM (52.88")	81,5 CM (32.16")	2317-0258	2317-0260
RANGER CREW 800 (FULL SIZE) 14-16	2317-0188	134,5 CM (52.88")	81,5 CM (32.16")	2317-0258	2317-0260
RANGER 900 XP 13-19	2317-0176	127,5 CM (50.13")	75 CM (29.61")	2317-0258	2317-0261
RANGER 1000 XP 17	2317-0176	127,5 CM (50.13")	75 CM (29.61")	2317-0258	2317-0261
RANGER 1000 XP 18-19	2317-0434	-	-	2317-0258	2317-0261
RANGER CREW 900 - (FULL SIZE) 14-19	2317-0176	127,5 CM (50.13")	75 CM (29.61")	2317-0258	2317-0261
RANGER CREW 900-6 (FULL SIZE) 15-16	2317-0176	127,5 CM (50.13")	75 CM (29.61")	2317-0258	2317-0261
RANGER CREW XP 1000 (FULL SIZE) 17-18	2317-0176	127,5 CM (50.13")	75 CM (29.61")	2317-0258	2317-0261
RANGER CREW XP 1000 (FULL SIZE) 19	2317-0434	128 CM (50.38")	74,5 CM (29.34")	2317-0258	2317-0261
RZR 570 12-19	2317-0190	100,5 CM (39.50")	61 CM (23.97")	2317-0258	2317-0260
RZR800 08-14	2317-0190	100,5 CM (39.50")	61 CM (23.97")	2317-0258	2317-0260
RZR900 XP 11-14	2317-0190	100,5 CM (39.50")	61 CM (23.97")	2317-0258	2317-0260
RZR900 XP & S 15-19	2317-0303	99 CM (38.97")	58 CM (22.89")	2317-0258	2317-0260
RZR1000 14-19	2317-0303	99 CM (38.97")	58 CM (22.89")	2317-0258	2317-0260
RZR XP 4 1000 15-19	2317-0303	99 CM (38.97")	58 CM (22.89")	2317-0258	2317-0260
RANGER ETX (MID SIZE) 15-17	2317-0299	114,5 CM (45.12")	68,5 CM (26.89")	2317-0258	2317-0261
RANGER EV (ELECTRIC) (MID SIZE) 15-19	2317-0299	114,5 CM (45.12")	68,5 CM (26.89")	2317-0258	2317-0261
RANGER DIESEL (FULL SIZE) 15-19	2317-0176	127,5 CM (50.13")	75 CM (29.61")	2317-0258	2317-0261
RANGER CREW DIESEL (FULL SIZE) 15-19	2317-0176	127,5 CM (50.13")	75 CM (29.61")	2317-0258	2317-0261
RANGER DIESEL HST DELUXE (FULL SIZE) 15-16	2317-0176	127,5 CM (50.13")	75 CM (29.61")	2317-0258	2317-0261
RANGER DIESEL (FULL SIZE) 14	2317-0188	134,5 CM (52.88")	81,5 CM (32.16")	2317-0258	2317-0260
RANGER CREW DIESEL (FULL SIZE) 14	2317-0188	134,5 CM (52.88")	81,5 CM (32.16")	2317-0258	2317-0260
GENERAL 16-19	2317-0358	122 CM (48.00")	57 CM (22.50")	2317-0258	2317-0260
YAMAHA					
RHINO(ALL MODELS) 04-12	2317-0192	127 CM (50.00")	71 CM (27.95")	2317-0258	2317-0260
VIKING 700 14-19	2317-0177	139,5 CM (54.98")	64,5 CM (25.33")	2317-0258	2317-0260
WOLVERINE 16-19	2317-0305	125 CM (49.12")	60,5 CM (23.90")	2317-0258	2317-0260
WOLVERINE X4 18-19	2317-0406	135,5 CM (53.35")	64 CM (25.23")	2317-0258	2317-0260
YZX 1000 16-18	2317-0359	119,5 CM (47.12")	56 CM (22.12")	2317-0258	2317-0260

¹ NOT FOR USE W/ HONDA OEM ROOF ² NO HOOD ACCESS

HARD COATED FULL FOLDING WINDSHIELDS

Hard coating on both sides. All benefits of a regular polycarbonate, but the hard coating makes it incredibly scratch resistant and prevents yellowing over time from the sun. Made in the USA.

FITS MODEL	COATED FULL FOLDING PART #	OVERALL WIDTH	OVERALL HEIGHT	REPL. RUBBER STRAPS PART #	REPL. HARDWARE PART #
POLARIS					
RANGER 570 (FULL SIZE) 15	2317-0369	127,5 CM (50.13")	75 CM (29.61")	2317-0258	2317-0261
RANGER CREW 570 (FULL SIZE) 15	2317-0369	127,5 CM (50.13")	75 CM (29.61")	2317-0258	2317-0261
RANGER 900 XP 13-19	2317-0369	127,5 CM (50.13")	75 CM (29.61")	2317-0258	2317-0261
RANGER CREW 900 (FULL SIZE) 14-19	2317-0369	127,5 CM (50.13")	75 CM (29.61")	2317-0258	2317-0261
RANGER CREW 900-6 (FULL SIZE) 15-19	2317-0369	127,5 CM (50.13")	75 CM (29.61")	2317-0258	2317-0261
RANGER CREW XP 1000 (FULL SIZE) 17-18	2317-0369	127,5 CM (50.13")	75 CM (29.61")	2317-0258	2317-0261
RANGER DIESEL (FULL SIZE) 15-19	2317-0369	127,5 CM (50.13")	75 CM (29.61")	2317-0258	2317-0261
RANGER CREW DIESEL-(FULL SIZE) 15-19	2317-0369	127,5 CM (50.13")	75 CM (29.61")	2317-0258	2317-0261
RANGER DIESEL HST DELUXE (FULL SIZE) 15-16	2317-0369	127,5 CM (50.13")	75 CM (29.61")	2317-0258	2317-0261
RANGER 570 (FULL SIZE) (ROUND TUBES) 16-19	2317-0370	134,5 CM (52.88")	81,5 CM (32.16")	2317-0258	2317-0260
RANGER 700/800 09-14	2317-0370	134,5 CM (52.88")	81,5 CM (32.16")	2317-0258	2317-0260
RANGER 700/800 CREW/6X6 10-14	2317-0370	134,5 CM (52.88")	81,5 CM (32.16")	2317-0258	2317-0260
RANGER 800 (FULL SIZE) 14	2317-0370	134,5 CM (52.88")	81,5 CM (32.16")	2317-0258	2317-0260
RANGER 800 6X6 FULL SIZE) 14-16	2317-0370	134,5 CM (52.88")	81,5 CM (32.16")	2317-0258	2317-0260
RANGER CREW 800 (FULL SIZE) 14-16	2317-0370	134,5 CM (52.88")	81,5 CM (32.16")	2317-0258	2317-0260
RANGER DIESEL (FULL SIZE) 14	2317-0370	134,5 CM (52.88")	81,5 CM (32.16")	2317-0258	2317-0260
RANGER CREW DIESEL (FULL SIZE) 14	2317-0370	134,5 CM (52.88")	81,5 CM (32.16")	2317-0258	2317-0260

UTILITY VEHICLE



HALF WINDSHIELDS

Premium 4,5 mm (0.177") thick clear polycarbonate shield. Stainless steel rubber coated mount clamps. Rubber trim at bottom of shield to help keep debris out. Made in the USA.

FITS MODEL	OVERALL WIDTH	OVERALL HEIGHT	PART#
CAN-AM			
COMMANDER (ALL) 11-19	134 CM (52.75")	45,5 CM (17.85")	2317-0201
MAVERICK 13-19	131,5 CM (51.75")	45 CM (17.75")	2317-0321
HONDA			
PIONEER 700 14-19	121,5 CM (47.82")	35 CM (13.70")	2317-0203
PIONEER 500 15-19	108 CM (42.50")	27,5 CM (10.75")	2317-0319
PIONEER 1000 16-19	138,5 CM (54.50")	28 CM (11.00")	2317-0380
KAWASAKI			
MULE 610 05-19	123 CM (48.40")	44,5 CM (17.50")	2317-0205 ¹
TERYX 2 & 4 12-15	139,5 CM (54.95")	36,5 CM (14.40")	2317-0204
POLARIS			
RANGER MIDSIZE MODELS 15-19	114 CM (45.00")	25,5 CM (10.00")	2317-0313
ACE 15-19	79,5 CM (31.25")	25 CM (9.75")	2317-0315
RANGER 700/800 09-12	134,5 CM (52.86")	46,5 CM (18.42")	2317-0197
RANGER 700/800 CREW 10-14	134,5 CM (52.86")	46,5 CM (18.42")	2317-0197
RANGER 400/500 ALL MODELS (MIDSIZE) 09-14	119 CM (46.86")	37 CM (14.50")	2317-0196
RANGER 900 XP 13-19	129 CM (50.71")	38 CM (15.00")	2317-0198
RANGER 1000 XP 16-19	129 CM (50.71")	38 CM (15.00")	2317-0198
RANGER 570 FULL SIZE 15-19	129 CM (50.71")	38 CM (15.00")	2317-0198
RANGER CREW XP 1000 16-19	129 CM (50.71")	38 CM (15.00")	2317-0198
RANGER CREW XP 900 13-19	129 CM (50.71")	38 CM (15.00")	2317-0198
RANGER CREW 570-6 15-19	129 CM (50.71")	38 CM (15.00")	2317-0198
GENERAL 16-19	127 CM (50.00")	23 CM (9.00")	2317-0381
RZR800 08-14	101,5 CM (39.87")	37 CM (14.60")	2317-0199
RZR900 XP 11-19	101,5 CM (39.87")	37 CM (14.60")	2317-0199
RZR1000 14-19	99 CM (38.98")	30 CM (11.75")	2317-0200
YAMAHA			
RHINO(ALL MODELS) 04-11	127 CM (50.05")	38 CM (14.93")	2317-0206
VIKING 700 15-19	139 CM (54.75")	44,5 CM (17.45")	2317-0202
WOLVERINE RSPEC 15-19	128,5 CM (50.50")	26 CM (10.25")	2317-0317
YXZ1000 16-18	132 CM (52.00")	23 CM (9.00")	2317-0382
REPLACEMENT SEAL	-	-	2317-0164

¹ NO HOOD ACCESS



FULL WINDSHIELDS

Premium .177" thick clear polycarbonate shield. Tool-less operation. Stainless steel rubber coated mount straps. Rubber seal helps keep elements out. Made in the USA.

FITS MODEL	OVERALL WIDTH	OVERALL HEIGHT	PART#
CAN-AM			
COMMANDER (ALL) 11-19	134 CM (52.75")	73,5 CM (28.95")	2317-0213
MAVERICK 13-19	131,5 CM (51.75")	75,5 CM (29.75")	2317-0322
HONDA			
PIONEER 500 15-19	108 CM (42.50")	82 CM (32.25")	2317-0320
PIONEER 700 14-19	121,5 CM (47.82")	72 CM (28.37")	2317-0215
PIONEER 1000 16-19	138,5 CM (54.50")	81 CM (32.00")	2317-0377
KAWASAKI			
MULE 600, 610, SX 05-19	121,5 CM (47.75")	93,5 CM (36.75")	2317-0417
MULE 3010 01-08	137 CM (54.00")	87,5 CM (34.37")	2317-0217 ¹
MULE 4010 09-19	134,5 (52.92")	74,5 CM (29.30")	2317-0216 ¹
POLARIS			
RANGER MIDSIZE MODELS 15-19	114 CM (45.00")	74,5 CM (29.25")	2317-0314
RANGER 700/800 09-12	132 CM (52.00")	89,5 CM (35.25")	2317-0415
RANGER 700/800 CREW 10-12	132 CM (52.00")	89,5 CM (35.25")	2317-0415
RANGER FULL-SIZE 10-12	132 CM (52.00")	89,5 CM (35.25")	2317-0415
RANGER 400/500/570 ALL MODELS (MIDSIZE) 11-14	119 CM (46.86")	73 CM (28.80")	2317-0207
RANGER 900 XP 13-19	129 CM (50.71")	78 CM (30.75")	2317-0209
RANGER 1000 XP 16-19	129 CM (50.71")	78 CM (30.75")	2317-0209
GENERAL 16-19	118 CM (46.50")	59,5 CM (23.50")	2317-0378
RZR800 08-14	101,5 CM (39.87")	64 CM (25.10")	2317-0211
RZR900 XP 11-14	101,5 CM (39.87")	64 CM (25.10")	2317-0211
RZR1000 14-17	99 CM (39.00")	61 CM (24.00")	2317-0416
RZR 900 14-19 RZR 1000 15-19	99 CM (39.00")	61 CM (24.00")	2317-0416
YAMAHA			
RHINO(ALL MODELS) 04-11	127 CM (50.05")	73 CM (28.80")	2317-0210
VIKING 700 14-19	139 CM (54.75")	70,5 CM (27.82")	2317-0214
WOLVERINE RSPEC 15-19	128,5 CM (50.50")	65,5 CM (25.75")	2317-0318
YZ1000 16-18	132 CM (52.00")	63,5 CM (25.00")	2317-0379
REPLACEMENT SEAL	-	-	2317-0164

¹ NO HOOD ACCESS



0521-1225

SOFT ROOF CAPS

Perfect for winter or rainy weather. Fastens to cage with adhesive backed hook and loop closures and heavy web straps. Made in the USA.

FITS MODEL	PART #
HONDA	
PIONEER 700 (BLACK)	0521-1523
PIONEER 1000 (BLACK)	0521-1522
KAWASAKI	
MULE 2500/3000/4000 SERIES (BLACK)	MUDKM116
MULE PRO FXT ALL (BLACK)	0521-1524
MULE PRO FX ALL (BLACK)	0521-1525
POLARIS	
FULL SIZE RANGER 02-08 (BLACK)	MUDPR108
RANGER 400/500 13-14 (MIDSIZE) (BLACK)	0521-1225
RANGER 900XP 13-18 (BLACK)	0521-1122
RANGER 900 CREW XP ALL (BLACK)	0521-1526
GENERAL 16-18 (BLACK)	0521-1521
YAMAHA	
VIKING 15-18 (BLACK)	0521-1369

PLOWES
WINCHES
UTV
RACKS
IMPLEMENTES & TOWING
LUGGAGE
BODY
CONTROLS
ELECTRICAL
WHEELS & TIRES
SUSPENSION & DRIVE
BRAKING
ENGINE
RIDER
GARAGE
PROMO

UTILITY VEHICLE

0521-0911



0521-1530



0521-1718



0521-0867



ONE PIECE ROOFS

Durable polyethylene w/ UV stabilizers. Extremely durable in cold weather. Molded in cargo tray allows for extra storage with bungees or cargo net. 20 lb weight limit. Must remove for trailering. Made in the USA.

TWO PIECE ROOFS

Durable polyethylene with UV stabilizers. Extremely durable in cold weather. Comes with all mounting hardware. Not for trailering. Made in the USA.

THREE PIECE ROOFS

Manufactured from durable, rotomolded LLDPE (linear low-density polyethylene). UV resistant, textured finish. Double wall construction provides extra rigidity and protection. Stainless steel mounting hardware. Made in the USA.



FITS MODEL	PART #	DIMENSIONS	STYLE
CAN-AM			
COMMANDER 800/1000 (ALL MODELS) 11-19	0521-0911	44.5" (113 CM) W X 129 CM (50.75") L X 20,5 CM (8") H	2 PIECE
MAVERICK 1000 13-19	0521-0911	44.5" (113 CM) W X 129 CM (50.75") L X 20,5 CM (8") H	2 PIECE
HONDA			
PIONEER 500 15-19	0521-1718	79 CM (31") W X 120 CM (47.25") L X 19 CM (7.5") H	1 PIECE
PIONEER 700 14-19	0521-1246	143,5 CM (56.5") W X 103 CM (40.5") L X 23 CM (9") H	2 PIECE
PIONEER 1000 16-19	0521-1530	155 CM (61") W X 91 CM (36") L	2 PIECE
KAWASAKI			
MULE 600, 610, SX 05-19	0521-1717	122 CM (48") W X 87,5 CM (34.5") L	1 PIECE
TERYX 750 08-11	0521-0867	150 CM (59") W X 76 CM (30") L X 12,5 CM (5") H	1 PIECE
POLARIS			
RZR 170 09-19	0521-1719	89 CM (35") W X 84,5 CM (33.25") L	1PIECE
RANGER 570 15-16 (MIDSIZE)	0521-1371	138,5 CM (54.5") W X 85 CM (33.5") L	2 PIECE
RANGER 570 XP 16 (FULLSIZE)	0521-1046	161,5 CM (63.5") W X 89 CM (35") L X 13,5 CM (5.25") H	2 PIECE
RANGER (MIDSIZE) 11-14 INCLUDES RANGER 570/800	0521-1107	147 CM (57.85") W X 79,5 CM (31.37") L X 13 CM (5.12") H	2 PIECE
RANGER 700/800 10-12 (FULLSIZE)	0521-0994	159 CM (62.5") W X 89 CM (35") L X 95 MM (3.75") H	2 PIECE
RZR (ALL MODELS) 12-14	0521-0864	87,5 CM (34.5") W X 109 CM (43") L X 16,5 CM (6.5") H	1 PIECE
RZR 570 15	0521-0864	87,5 CM (34.5") W X 109 CM (43") L X 16,5 CM (6.5") H	1 PIECE
RZR 570 08-19	0521-1527	104 CM (41") W X 97 CM (38") L	1 PIECE
RZR 900S 14-15	0521-1106	115,5 CM (45.5") W X 168 CM (66") L X 70 MM (2.75") H	1 PIECE
RZR1000 14-15	0521-1106	115,5 CM (45.5") W X 168 CM (66") L X 70 MM (2.75") H	1 PIECE
RZR900 15-19	0521-1528	98 CM (38.5") W X 97 CM (38") L	1 PIECE
RZR1000 14-19	0521-1528	98 CM (38.5") W X 97 CM (38") L	1 PIECE
RANGER 900XP 13-19	0521-1046	161,5 CM (63.5") W X 89 CM (35") L X 13,5 CM (5.25") H	2 PIECE
RANGER 1000 XP 17-19	0521-1046	161,5 CM (63.5") W X 89 CM (35") L X 13,5 CM (5.25") H	2 PIECE
GENERAL 16-19	0521-1529	91 CM (36") W X 127 CM (50") L	1 PIECE
YAMAHA			
RHINO (ALL MODELS) 04-12	0521-0867	150 CM (59") W X 76 CM (30") L X 12,5 CM (5") H	1 PIECE
UNIVERSAL			
UTVS WITH OUTER ROLL CAGE DIMENSIONS OF 60" W BY 36" L	0521-0868	152 CM (60") W X 110,5 CM (43.5") L X 14 CM (5.5") H	2 PIECE





**POLARIS
RANGER**



**POLARIS
RZR**

BED RAILS

Includes a head rail, two side rails, 5 twist lock quick detachable anchors, 2 corner brackets. Rails are 35,5 cm (14") high and span the entire width and length of the Polaris Ranger bed. Tool-less installation. All steel welded tubing. Powder coated for durability. Side rails have integrated accessory brackets that accommodate the use of optional accessories including spare tire bracket and chainsaw bracket. Made in the USA.

FITS MODEL	PART #
POLARIS	
RANGER 400/500/570/800 MID SIZE 10-19	0521-1124
RANGER 700/800/900 FULL SIZE 06-19	0521-1125

CARGO BED RACKS

Spans the entire width of the bed. All steel welded tubing. Powder coated for durability. Available accessories include spare tire bracket and chainsaw holder for Polaris RZR. Made in the USA.

FITS MODEL	PART #
POLARIS	
RZR 570 (ALL)	1512-0158
RZR 800, 800S, 800-4 08-14	1512-0156
RZR 900 10-14	1512-0157
RZR 900 15-18	1512-0184
RZR 1000 14-18	1512-0171
ACE 14-18	1512-0176
GENERAL 17-19	1512-0201
YAMAHA	
WOLVERINE 15-19	1512-0190
ACCESSORIES	
CHAINSAW BRACKET FOR RZR (SEE PAGE 39)	1512-0164



REAR BASKET

Rugged and durable basket. 14-gauge steel with a 25,4 mm (1") tubing on top. Measures 113 cm (44 1/2") L x 70 cm (27 1/2") W x 30,5 cm (12") D. Powder coated with texture powder paint. All steel mounting hardware included.

FITS MODEL	PART #
HONDA	
PIONEER 500 REAR BASKET (ALL)	1512-0227



HOOD RACKS

Two piece tubular steel basket. No drilling or tools required. Allows items to be strapped down to multiple mounting points on the hood rack. Placing your items in a hood rack allows you to dump your bed without unloading or rearranging. Add 30% more storage space.

FITS MODEL	PART #
POLARIS	
FULL & MID SIZE RANGERS 09-14-ROUND ROLL CAGE	1512-0191
FULL & MID SIZE PRO FIT RANGER 15-18	1512-0192 ¹
YAMAHA	
VIKING / VIKING VI 15-18	1512-0193

¹ WILL NOT FIT RANGER 1000XP 18



BED TOPPER

Fits all RZR 800 two and four passenger vehicles. Durable polyethylene with UV stabilizers. Dimensions: 122 cm (48") L x 75,5 cm (29 3/4") W. Made in the USA.

FITS MODEL	PART #
POLARIS	
RZR 800 08-14	0521-0993



SADDLEBOX

Easy installation to Polaris Ranger bed rails using the Polaris Lock & Ride locations. Includes two lock and ride plungers. Provides 1.1 cubic feet of weather resistant storage in each box. Features a lockable latch. Rugged roto-molded design. Dimensions: 56 cm (22") L x 31 cm (12 1/4") W x 32 cm (12 1/2") H. Made in the USA.

FITS MODEL	PART #
POLARIS	
RANGER 05-19	1512-0216

UTILITY VEHICLE



1512-0161



1512-0208

TWIST N LOCK ANCHORS

Replacement twist n lock anchors for all RZR and Ranger/General racks and bed rails. RZR sold as a 4-pack. Ranger sold as a 2-pack. Made in the USA.

DESCRIPTION	PART #
POLARIS	
RZR TWIST N LOCK ANCHORS	1512-0161
RANGER/GENERAL TWIST N LOCK ANCHORS	1512-0208



1512-0211



1512-0212

TWIST N LOCK TIE DOWN ANCHORS

Twist lock anchors include eye nuts on the top for your tie down. Simply insert the anchors in the bed hole of your Ranger/General or RZR/Sportsman; tighten and go. Great for tying down loads and gear. RZR/Sportsman sold in 4-packs, Ranger/General sold in 4-packs. Made in the USA.

DESCRIPTION	PART #
POLARIS	
RZR/SPORTSMAN TIE DOWN ANCHORS	1512-0211
RANGER/GENERAL TIE DOWN ANCHORS	1512-0212

ROLLBAR ACCESSORY CLAMP

Mount accessories to the roll cage with these clamps. Mount windshields, lights, mirrors, etc. Quick-release without tools. Sold each, universal fit. Fits 25,4 mm (1") - 44,5 mm (1 3/4") tubing.



DESCRIPTION	PART #
POLARIS	
ROLLBAR ACCESSORY CLAMP	4510-1173
HANDLEBAR ACCESSORY CLAMP	4510-1174



TOOL MOUNTS

Rubber quick connects allow for shovels, rakes, trimmers and a variety of other tools to quickly and securely attach to your bed. Can be mounted anywhere inside or outside the bed in either an inverted or upright position. Comes complete with Twist Lock anchors for tool less installation. Shovel not included. Sold as pairs. Made in the USA.

FITS MODEL	PART #
POLARIS	
RANGER/GENERAL MODELS 06-17	1512-0209



FUEL CAN/TOOL HOLDERS

Each holder includes a 2 gallon CARB/CRC complaint fuel can and two twist n lock anchors for installation in to the bed of your Ranger. Chainsaw/shovel not included. Made in the USA.

FITS MODEL	PART #
POLARIS	
RANGER/GENERAL FULLSIZE, MIDSIZE, EV ALL MODELS 06-17	
FUEL CAN WITH SPARE TIRE CARRIER & TOOL HOOKS	1512-0205
FUEL CAN WITH CHAINSAW BRACKET & TOOL HOOKS	1512-0206



CHAINSAW BRACKET

Machined out of solid high density polyethylene for maximum durability. Mount your chainsaw vertically for simple safe transport. Bracket includes 2 Quick Detachable anchors and installation hardware to mount it on RZR bed rails and RZR cargo racks. Chainsaw not included. Made in the USA.

DESCRIPTION	PART #
POLARIS	
RZR (ALL)	1512-0164



ROLL BAR CHAINSAW MOUNT

Perfect for Utility vehicles as well as sport vehicles such as the RZR, Yamaha YXZ, Can-Am and virtually any off-road vehicle with round roll bars. Machined from solid, high-density polyethylene and integrated to two heavy-duty fast clamps. Offers the best in support and security for your chainsaw when mounted on either a horizontal or vertical round roll bar or bumper. Fast clamps fit round pipe/tube 38,1 mm (1 1/2") to 44,5 mm (1 3/4") diameter. Chainsaw not included.

DESCRIPTION	PART #
ROLL BAR CHAINSAW MOUNT	1512-0221



CHAINSAW BRACKET

Machined out of solid high density polyethylene for maximum durability. Mount your chainsaw vertically for simple safe transport. Bracket includes 2 Quick Detachable anchors and installation hardware to mount it on bed rails and cargo racks. Chainsaw not included. Made in the USA.

DESCRIPTION	PART #
POLARIS	
RANGER/GENERAL (FITS ALL)	1512-0203

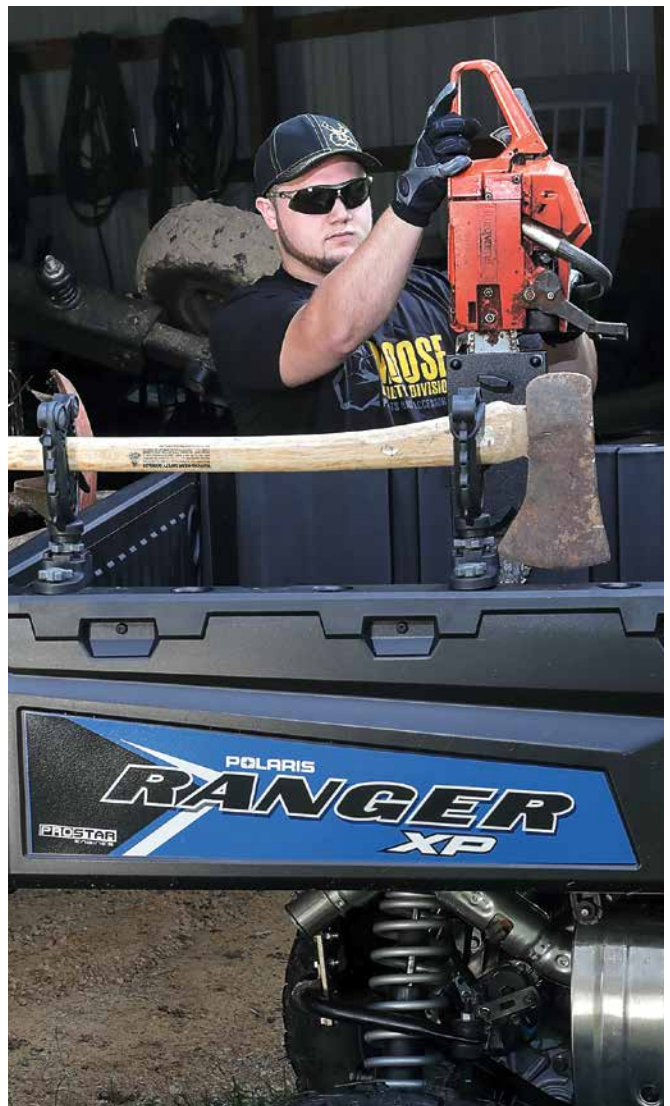

- PLOWES
- WINCHES
- UTV
- RACKS
- IMPLEMENTES & TOWING
- LUGGAGE
- BODY
- CONTROLS
- ELECTRICAL
- WHEELS & TIRES
- SUSPENSION & DRIVE
- BRAKING
- ENGINE
- RIDER
- GARAGE
- PROMO



ELITE SERIES UTV CAM LOCK GRIP

Large design grabs guns, bow and handled objects. Quick and easy adjustment, custom fit. Snubber free design. Mounts to all tubular UTV racks up to 51 mm (2"). Gun not included.

DESCRIPTION	PART #
ELITE SERIES UTV CAM LOCK GRIP	3518-0175



GUN DEFENDER™ CASE

Injection molded design offers great strength and more water and dust resistance. Defender design accommodates standard and longer barreled guns. Additional width in the right places eliminates interferences with bolts and target style turrets. Hybrid interior structure allows customization and securely holds and protects guns.

UTV UNIVERSAL HITCH MOUNT SYSTEM

Universal model fits all UTVs with 32 mm (1 1/4") or 51 mm (2") receiver hitch. Quick and easy adjustments, quick install and take down. Adjustable stabilization arm adds rigidity and protection. Highly adjustable design allows for endless mounting configurations. Comes with all necessary pieces to mount two Gun Defender™ Transport Systems.

UNIVERSAL BED MOUNT SYSTEM

Universal model fits all UTV Beds. Quick and easy adjustments, quick install and take down. Width adjustment from 66 cm (26") to 142 cm (56"). Mounting system locks down with two turnbuckles and D-rings (included). Highly adjustable design allows for endless mounting configurations. Comes with all necessary pieces to mount two Gun Defender™ Transport System.

What to order: Gun Defender™ Case and one of the two mounting system options.

DESCRIPTION	PART #
GUN DEFENDER™ CASE	3518-0135
UTV UNIVERSAL HITCH MOUNT SYSTEM	3518-0137
UNIVERSAL BED MOUNT SYSTEM	3518-0138



HERITAGE UTV GUN RACK

Fits most popular UTVs with cargo beds. Attaches securely with lag screws and bolts to sides of bed. Holds up to four firearms (two on each side) mounted at an upward angle for added safety. Constructed of heavy duty aircraft aluminum. Adjustable gun clips offer a snug and secure fit. Guns not included.

DESCRIPTION	PART #
HERITAGE UTV GUN RACK	3518-0171



QUICK DRAW UTV OVERHEAD GUN CARRIER

Holds two guns securely in the inside roof area of the UTV. Unique mounting system installs in just minutes without drilling or bolting. Features super-soft rubber gun clips that provide easy access and secure transport. Fits UTVs with upper roof frames that measure 58,5 cm (23") - 71 cm (28") from front to back. Guns not included. Made in the USA.

FITS MODEL	PART#	FITS MODEL	PART#
CAN-AM		POLARIS	
COMMANDER (ALL)	3518-0167	RANGER 570 FULL SIZE 14-15	3518-0165
HONDA		RANGER 570 MID-SIZE 15	3518-0164
BIG RED 08-14	3518-0168	RANGER 900 DIESEL 13-14	3518-0168
PIONEER 700-4 14-15 (BACK ONLY)	3518-0166	RANGER 800 MID-SIZE 14	3518-0168
PIONEER 1000 16	3518-0169	RANGER 800 DIESEL 14	3518-0168
JOHN DEERE		RANGER 800 CREW CAB	3518-0167
GATOR 825 XUV/624 I 04-14	3518-0170	RANGER 900 XP 13-16	3518-0165
KAWASAKI		RANGER CREW 900 14-16	3518-0165
MULE 610 (ALL)	3518-0168	RZR900/1000 14-15	3518-0167
TERYX 4 (ALL)	3518-0167	GENERAL 1000 16	3518-0164
MULE 4010 4X4 09-15	3518-0168	YAMAHA	
MULE 4010 TRANS 4X4 11-15	3518-0170	VIKING 14-15	3518-0170
MULE PRO FXT 16	3518-0169	WOLVERINE 15-16	3518-0170
KUBOTA			
RTV500 08-14	3518-0168		
RTV 900 06-12	3518-0167		
RTV 1140 CREW 13-14	3518-0167		

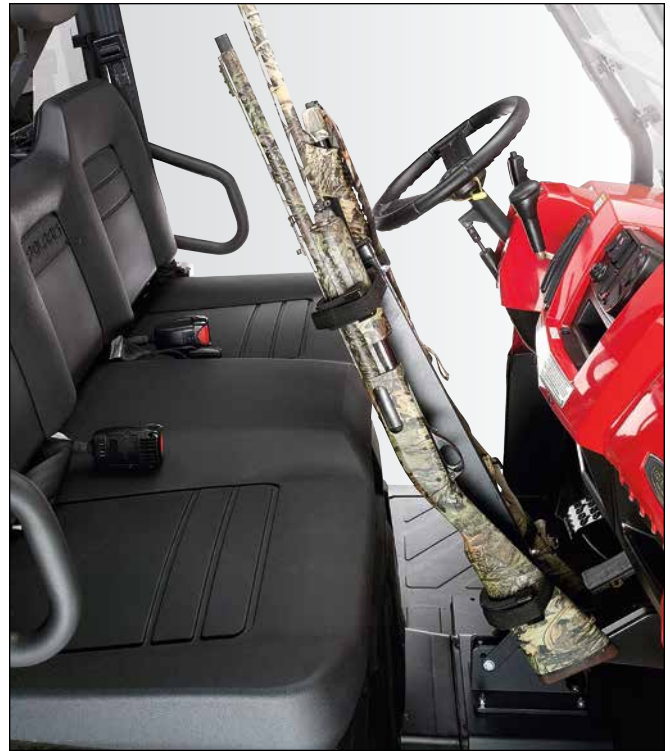

QUICK DRAW UTV GUN RACK

The Quick-Draw holds two guns (shotgun, rifle or muzzleloader) securely and protected in a soft, cushioned cradle. Unlike conventional clips and loops, our unique hook and loop pull-tabs form and fit the holding cradles to the exact size of the stock or forearm of the gun it is holding - no more loose fits to disturb the sight and scope settings! Constructed of aircraft aluminum and finished off with super tough powder coat paint for years of good looks and dependable service. Comes with all necessary hardware for quick and easy installation. Will not work on Yamaha Rhino. Not intended for carrying loaded guns. Guns not included. Made in the USA.

FITS MODEL	PART #
QUICK DRAW UTV GUN RACK	3518-0172
RANGER 900XP 13-15 ADAPTER PLATE	3518-0173



UTV ROLL CAGE GUN RACK

Transport two firearms safely, securely and out of the way. Mounts snugly to the back of UTVs with cab frames measuring 127 cm (50") to 163 cm (64") wide. Can be installed, or removed in seconds. Made from aircraft aluminum and finished with tough, powder coated paint for years of durability. Guns not included. Made in the USA.

DESCRIPTION	PART #
UTV ROLL CAGE GUN RACK	3518-0018



DOUBLE CROSSBOW RACK

Securely transports two full-sized crossbows. Held in place with cushioned, hook and loop secured cradles that mount to the upper rails of the UTV bed. Aircraft aluminum construction. Mounting plates and hardware included. (If used on Polaris Rangers, the mounting plates accommodate use of the bed peg holes, but the necessary twist n lock anchors are not included). See page 38 for the twist n lock anchors. Crossbows not included. Made in the USA.

DESCRIPTION	PART #
DOUBLE CROSSBOW RACK	3518-0125



SPARE TIRE ATTACHMENT

Bracket anchors for simple, tool-less installation that allows for the secure mount and transport of your spare tire. Fits all wheel and tire sizes. Simple installation and removal lets you quickly carry your spare, or leave it at home. Allows for your spare tire to be stored safely and securely in the inside of the bed. Tire/wheel not included. Made in the USA.

FITS MODEL	PART #
POLARIS FULL SIZE AND MID-SIZE RANGERS (ALL)	1512-0202



RECEIVER HITCH SPARE TIRE MOUNT

The unique off-road design of a curved bottom insert with a fully adjustable height to provide the ultimate in convenience when carrying a spare tire on a UTV. Fits all 50,8 mm (2") receivers including ATVs and UTVs. The vertical arm can be adjusted to a number of different heights or you can simply remove the pin and pull off your spare to access the back of your vehicle. Tire/wheel not included. Made in the USA.

DESCRIPTION	PART #
RECEIVER HITCH SPARE TIRE MOUNT	1512-0222



SPARE TIRE CARRIER

Works well attached to the frame of the UTV or top or back of the cab. Installs with no drilling or bolting required. Spare tire is held in place with two mounting studs and secured with easy-grip, fluted wing-knobs. Fits UTVs with frames (roll bars) from 127 cm (50") - 163 cm (64") wide. Tire/wheel not included. Made in the USA.

DESCRIPTION	PART #
SPARE TIRE CARRIER	1512-0173



SPARE TIRE CARRIER

Fits OEM cages. Two hinge points at the rear for better stability. Highly adjustable for best possible fit. More bed storage clearance. Holds up to 81 cm (32") wheel/tire. Tire/wheel not included.

FITS MODEL	PART #
POLARIS RZR XP 1000 (ALL)	1512-0239



UTV GRAB HANDLES

Made with the highest quality paracord. Ensures that your grab handles are durable, strong and will look great for years to come. Rugged and holds up to the most extreme conditions. Fits all UTVs. Sold in pairs. Made in the USA.

DESCRIPTION	PART #
BLACK	0521-1418
YELLOW	0521-1309



UTV ENTRY ASSIST HANDLES

Entry assist handles attach to all utility vehicles with up to 10 cm (4") roll bars. Assists in entry and exit of your utility vehicle. Sold in pairs.

DESCRIPTION	PART #
UTV ENTRY ASSIST HANDLES	4510-0051



PLOWS

WINCHES

UTV

RACKS

IMPLEMENTS
& TOWING

LUGGAGE

BODY

CONTROLS

ELECTRICAL

WHEELS
& TIRES

SUSPENSION
& DRIVE

BRAKING

ENGINE

RIDER

GARAGE

PROMO

0640-1088



0640-0754



POLARIS RANGER PRO FIT ROLL CAGE MIRRORS

Heavy-duty steel bracket designed specifically for the Ranger Pro Fit Cage. High impact ABS plastic housing resists damage. Convex mirror provides wider viewing range and image stabilization. Shatter resistant glass for increased safety. Multiple ball socket joints provide wide range of adjustability. Break-away housing folds back upon impact to keep the mirror from breaking. Side mirrors sold as pairs, rear view sold each.

FITS MODEL	PART #
POLARIS	
RANGER 900XP 13-18 AND ALL 15-18 MODELS	
SIDE MIRRORS	0640-1088
REAR VIEW MIRROR	0640-0754



UTV AUTO STYLE REAR VIEW MIRRORS

Auto styled. Highly adjustable dual ball joints. Simple 1-screw setup. Shatter resistant tempered safety glass and high impact ABS housing. Convex mirror for wider viewing angles and image stability. 44,5 mm (1 3/4") and 51 mm (2") steel bar clamp option for maximum strength and durability. Styling matches side view mirrors.

FITS MODEL	PART #
CAN-AM	
COMMANDER AND MAVERICK (51 MM (2") CLAMP)	0640-0857
JOHN DEERE	
GATOR HPX & XUV (44,5 MM (1.75") CLAMP)	0640-0735
KAWASAKI	
MULE 3000 (44,5 MM (1.75") CLAMP)	0640-0735
POLARIS	
RANGERS (44,5 MM (1.75") CLAMP)	0640-0735
RZR (44,5 MM (1.75") CLAMP)	0640-0735



0640-1196



ADD-ON RED ACCENT



ADD-ON BLUE ACCENT

ELITE SERIES UTV CENTER MIRROR

One fixed center mirror, two adjustable blind spot mirrors. High quality construction. Low profile clamps/mounting. Provides a perfect viewing position on any configuration of roll cage. 35,5 cm (14") W x 11,5 cm (4 1/2") H. Comes with black frame. Add-on accent frames sold separate.

DESCRIPTION	PART #
ELITE SERIES UTV CENTER MIRROR	0640-1196
ADD ON RED ACCENT FRAME	0640-1377
ADD ON BLUE ACCENT FRAME	0640-1378



ELITE SERIES UTV SIDE MIRROR

3-way adjustable view orientation. Low profile universal clamps/mounting. Spring load dual axis break away mechanism. Anti-vibration technology. Fits 38 mm (1 1/2") - 57 mm (2 1/4") tubular roll cages. Fits right or left. Sold as each. Comes with black frame. Add-on accent frames sold separate.

DESCRIPTION	PART #
ELITE SERIES UTV SIDE MIRROR	0640-1194
ADD ON RED ACCENT FRAME	0640-1373
ADD ON BLUE ACCENT FRAME	0640-1374

ELITE SERIES PRO UTV SIDE MIRROR

3-way adjustable view orientation. Low profile universal clamps/mounting. Spring load dual axis break away mechanism. Anti-vibration technology. Fits 38 mm (1 1/2") - 57 mm (2 1/4") tubular roll cages. Fits right or left. Sold as each. Comes with black frame. Add-on accent frames sold separate.

DESCRIPTION	PART #
ELITE SERIES UTV SIDE MIRROR	0640-1195
ADD ON RED ACCENT FRAME	0640-1375
ADD ON BLUE ACCENT FRAME	0640-1376



REAR & SIDE VIEW UTV MIRROR

38 mm (1 1/2"), 44 mm (1 3/4") and 51 mm (2") bar clamps all included. Break away feature allows mirror to fold back upon impact. Ball socket joint provides a broad range of viewing angles. High impact ABS plastic housing helps resist damage. Convex mirror provides wider viewing range and image stabilization. Shatterproof tempered glass for increased safety.



DESCRIPTION	PART #
REAR & SIDE VIEW UTV MIRROR	0640-1193



BREAKAWAY FEATURE

UTV UNIVERSAL SIDEVIEW MIRRORS

Pivoting clamp bracket allows for greater range viewing angles. Flip back, fold away feature to prevent damage on impact. Shatter resistant tempered safety glass. Convex mirror for wider viewing angles. 44 mm (1 3/4") - 48 mm (1 7/8") and 51 mm (2") steel bar clamp. Tension adjuster to keep mirror swing stiff. Sold in pairs.

DESCRIPTION	PART #
38 MM (1 1/2") CLAMP	0640-1086
44 MM (1 3/4")	0640-1085
51 MM (2") CLAMP	0640-1087



UTV LED LIGHTED MIRRORS

6063 die cast billet aluminum housing with a fully adjustable glass mirror. Fully adjustable 44 mm (1.75") - 51 mm (2.00") tube mount included. Integrated LEDs for use as running lights. Complete with plug-n-play wiring harness and lighted rocker switch. Sold as a pair.

DESCRIPTION	PART #
REAR & SIDE VIEW UTV MIRROR	0640-1381



UTV REARVIEW/SIDEVIEW MIRROR

Fits side or cross bar of roll cage. Wide range of adjustment. Convex mirror for wider viewing angles & image stability. Shatter resistant tempered safety glass.

FITS MODEL	PART #
ARCTIC CAT	
PROWLER (ROUND ROPS) (44 MM (1.75"))	0640-0386
CAN-AM	
COMMANDER (51 MM (2") W/ SHIM)	0640-0582
JOHN DEERE	
GATOR HPX/XUV (44 MM (1.75"))	0640-0386
KAWASAKI	
MULE 600 (51 MM (2") W/ SHIM) 08-14	0640-0582
MULE 3000 (44 MM (1.75"))	0640-0386
MULE 4000 (51 MM (2") W/ SHIM) 08-14	0640-0582
TERYX (51 MM (2") W/SHIM) 08-14	0640-0582
KUBOTA	
RTV900, RTV1140 (51 MM (2") W/ SHIM)	0640-0582
POLARIS	
RANGER & RZR'S (44 MM (1.75"))	0640-0386
YAMAHA	
RHINO (44 MM (1.75"))	0640-0386



UTV ROLL BAR 6-PACK COOLER

Thick padding with twin straps fastens to roll cage of UTV. Also can fasten to tubular racks on ATVs. Made to hold six 12 oz. cans.

DESCRIPTION	PART #
BLACK	3511-0006



ELITE SERIES UNIVERSAL FIRE EXTINGUISHER MOUNT

Universal design mounts on tubular roll cages up to 51 mm (2"). Quick release pin. Heavy duty design. Adjustable clamps fit most fire extinguishers. Fire extinguisher not included.

DESCRIPTION	PART #
FIRE EXTINGUISHER MOUNT	4050-0049



ELITE SERIES UNIVERSAL ADJUSTABLE FLAG WHIP MOUNT

Mounts to all tubular roll cages up to 51 mm (2"). Cam lock design allows micro adjustment. Quick store fold down feature. Mounts to right or left side. Fire extinguisher not included.

DESCRIPTION	PART #
ADJUSTABLE FLAG WHIP MOUNT	0521-1751

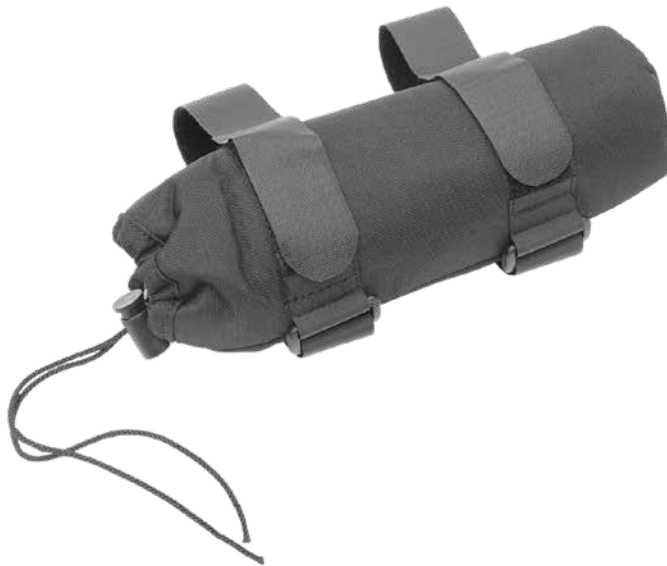

UTV FIRE EXTINGUISHER HOLDER

Thick padding with twin straps fastens to roll cage of UTV. Drawstring top with cord lock secures fire extinguisher in place for mounting in any direction. Also fastens to tubular racks on ATVs. For use with most household or shop fire extinguishers. Fire extinguisher not included.

DESCRIPTION	PART #
BLACK	4050-0025



POLARIS FLAG MOUNT

Includes the integrated Twist Lock Anchor, grey machined base mount, all hardware and coupling nut. Simple drop-and-twist installation in your Polaris Ranger/General or RZR bed hole. Can also accommodate most other flag bases and spring mounts. Made in the USA.

FITS MODEL	PART #
RZR & SPORTSMAN	0521-1306
RANGER/GENERAL	0521-1531

EXHAUST TIPS

Made from CNC-billet aluminum. Angled exhaust port and machined gun barrel divots on the tip. Angle directs exhaust flow down and away from fenders and tailgates. Comes with mounting bolts and screen. Made in the USA.

FITS MODEL	PART #
KAWASAKI	
TERYX 750 08-12	1861-0481
YAMAHA	
RHINO 450 04-09	1861-0374
RHINO 660 04-07	1861-0374
RHINO 700 08-13	1861-0485



1861-0481



1861-0374



4510-0545



4510-0642



4510-0547

UTV CAB HEATERS

12-volt universal cab heater kit for UTVs with 25,4 mm (1") and 19,1 mm (¾") radiator hoses. Quick and easy installation. Typically installs in about an hour. Water operated. Made in the USA.

FITS MODEL	PART #
CAB HEATERS	
ARCTIC CAT	
WILDCAT 15-18	4510-1122 ¹
CAN-AM	
COMMANDER 09-18	4510-0939 ¹
MAVERICK 1000 13-19	4510-0940 ¹
DEFENDER 1000 HD10 16-19	4510-1114 ¹
DEFENDER 1000 HD10 16-17	4510-1114 ¹
MAVERICK TRAIL 18-19	4510-1206 ¹
MAVERICK X3 17-19	4510-1213 ¹
HONDA	
PIONEER 700 14-18	4510-0750 ¹
PIONEER 700 17-18 (with POWER STEERING)	4510-1237 ¹
PIONEER 500 15-18	4510-1087 ¹
PIONEER 1000 16-18	4510-1086 ¹
TALON 1000 19	4510-1238
KAWASAKI	
TERYX & 4 800 14-19	4510-1085 ¹
MULE PRO-FX/FXT 16-19	4510-1235 ¹
MULE PRO-FXR 18-19	4510-1235 ¹
POLARIS	
RANGER 570 MIDSIZE 15-19	4510-1115 ¹
RANGER 570 FULL SIZE 13-16	4510-1181 ¹
RANGER 570 FULL SIZE 17-19	4510-1182 ¹
RZR 570 12-18 (W/O POWER STEERING)	4510-0938 ³
RZR 570 12-18 (WITH POWER STEERING)	4510-1212 ¹
RANGER 800 10-15	4510-0641 ¹
RZR 800/900 08-14 (W/O POWER STEERING)	4510-0547 ³
RZR 800/900 08-14 (WITH POWER STEERING)	4510-0796 ³
RANGER 900 XP 13-18	4510-0642 ¹
RANGER XP 900/1000 4-SEAT CREW 13-18	4510-1415
RZR-S 900 15-19	4510-1211 ¹
GENERAL 1000 16-19	4510-0941 ¹
RZR 1000 XP 14-18	4510-0841 ¹
RANGER 1000XP CREW 19	4510-1416
RANGER 1000 XP 17	4510-1113 ¹

FITS MODEL	PART #
CAB HEATERS	
POLARIS (CON'T)	
RZR 1000 XP 14-18	4510-0841 ¹
RZR XP 1000 TURBO 16-18	4510-1203 ¹
RZR TURBO DYNAMIX EDITION 18	4510-1204 ¹
RANGER 1000 XP 18	4510-1205 ¹
RZR TURBO S 19 CAB HEATER	4510-1229 ¹
RZR RS1 19	4510-1414
TEXTRON	
WILDCAT 1000XX 18-19	4510-1230 ¹
PROWLER 500 15-19	4510-1231 ¹
PROWLER PRO 18-19	4510-1232 ¹
STAMPEDE 16-18	4510-1233 ¹
HAVOC 18	4510-1234 ¹
YAMAHA	
VIKING 14-18	4510-1123 ¹
YZZ 1000 16-18	4510-1116 ¹
WOLVERINE 16-18	4510-1183 ¹
WOLVERINE X2 19	4510-1236 ¹
WOLVERINE X4 18-19	4510-1207 ¹
UNIVERSAL	
FOR MACHINES WITH 25,4 MM (1.00") RADIATOR HOSES	4510-0545 ⁴
FOR MACHINES WITH 19,1 MM (0.75") RADIATOR HOSES	4510-0546 ⁴

¹ WITH DEFROST, HIDDEN UNDER HOOD ² WITH DEFROST, FLOOR MOUNT
³ WITH DEFROST, UNDER DASH ⁴ FLOOR MOUNT



Y-FITTING 25,4 MM (1") HOSE TO 15,9 MM (5/8") W/ SHUTOFF VALVE KIT

This fitting is commonly used on UTV heaters. Universal fit for many UTVs. Allows you to splice into your 25,4 mm (1") radiator hose to run coolant to your heater with 15,9 mm (5/8") heater hose. Included in this kit is the shutoff valve so you can shut the flow of coolant off to the heater during the summer months. Made from aluminum. Made in the USA.

DESCRIPTION	PART #
Y-FITTING 25,4 MM (1") HOSE TO 15,9 MM (5/8") W/ SHUTOFF VALVE KIT	4510-1119



OZARK UTV COVER

Made from strong, urethane coated black nylon. Water-resistant. Made to fit most utility vehicles. Measures 305 cm (120") L x 165 cm (65") W x 193 cm (76") H. Comes with storage bag.

DESCRIPTION	PART #
OZARK UTV COVER	4002-0058



HARNESS SYSTEMS

Four point restraint system. 51 mm (2") W straps for comfort and safety. Extra-large padded chest/shoulder straps. Easy adjustment and release of the shoulder and lap straps. Single click automotive buckle for easy entry and exit. Integrated chest buckle to keep the straps in place on your shoulder. Universal bolt in or loop over roll cage installation for most UTV's. Moose Racing® logo's on the chest straps. Sold as each.

DESCRIPTION	PART #
BLACK	4510-1243
RED	4510-1244
BLUE	4510-1245
GREY	4510-1246



SEAT BELT SLEEVES

Relieves chafing, rubbing and discomfort from seat belt straps. Hook and loop fastener allows sleeves to easily slide over belts. 51 mm (2") W x 28 cm (11") L. Sold in pairs.

DESCRIPTION	PART #
SEAT BELT SLEEVES	4510-1413



PROMO
GARAGE
RIDER
ENGINE
BRAKING
SUSPENSION & DRIVE
WHEELS & TIRES
ELECTRICAL
CONTROLS
BODY
LUGGAGE
IMPLEMENTS & TOWING
RACKS
UTV
WINCHES
PLOWS

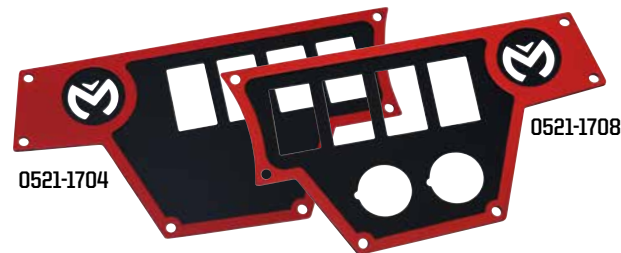
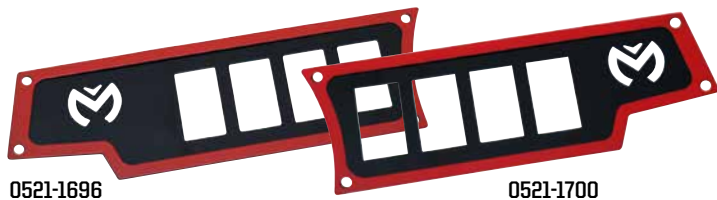
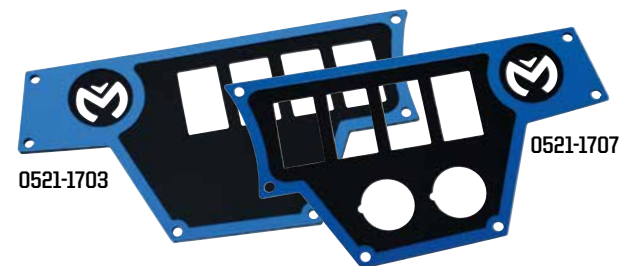
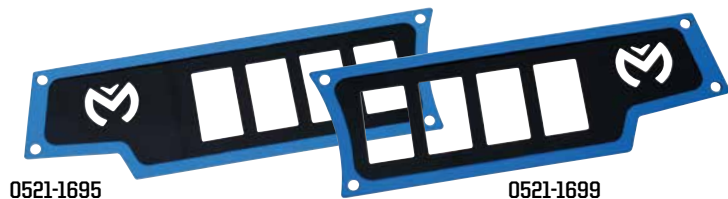
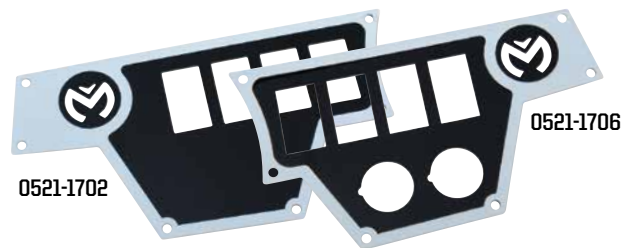
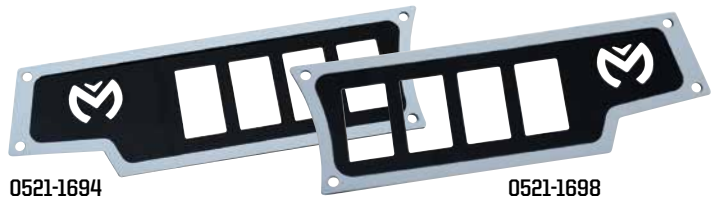

RZR DASH PLATES

Add additional switches to your RZR for lights and accessories and gives you a custom look. Made of durable powder coated steel. Many different variations available for your RZR. Available in four different color options. Switches are not included.

FITS MODEL	PART #	STYLE	PLACEMENT	COLOR
POLARIS				
RZR 900 15-19,	0521-1693	SMALL - 4 SWITCH	LEFT SIDE	BLACK
RZR 1000 (ALL, EXCEPT RIDE COMMAND MODELS) 14-18,	0521-1694	SMALL - 4 SWITCH	LEFT SIDE	WHITE
RZR TURBO 16-17	0521-1695	SMALL - 4 SWITCH	LEFT SIDE	BLUE
	0521-1696	SMALL - 4 SWITCH	LEFT SIDE	RED
	0521-1697	SMALL - 4 SWITCH	RIGHT SIDE	BLACK
	0521-1698	SMALL - 4 SWITCH	RIGHT SIDE	WHITE
	0521-1699	SMALL - 4 SWITCH	RIGHT SIDE	BLUE
	0521-1700	SMALL - 4 SWITCH	RIGHT SIDE	RED
	0521-1701	LARGE - 4 SWITCH	LEFT SIDE	BLACK
	0521-1702	LARGE - 4 SWITCH	LEFT SIDE	WHITE
	0521-1703	LARGE - 4 SWITCH	LEFT SIDE	BLUE
	0521-1704	LARGE - 4 SWITCH	LEFT SIDE	RED
	0521-1705	LARGE - 4 SWITCH, 2 12V	RIGHT SIDE	BLACK
	0521-1706	LARGE - 4 SWITCH, 2 12V	RIGHT SIDE	WHITE
	0521-1707	LARGE - 4 SWITCH, 2 12V	RIGHT SIDE	BLUE
	0521-1708	LARGE - 4 SWITCH, 2 12V	RIGHT SIDE	RED
RZR 570 12-18,	0521-1709	5 SWITCH	CENTER	BLACK
RZR 800 08-14,	0521-1710	5 SWITCH	CENTER	WHITE
RZR 900 11-14	0521-1711	5 SWITCH	CENTER	BLUE
	0521-1712	5 SWITCH	CENTER	RED
	0521-1713	4 SWITCH, 1 12V	CENTER	BLACK
	0521-1714	4 SWITCH, 1 12V	CENTER	WHITE
	0521-1715	4 SWITCH, 1 12V	CENTER	BLUE
	0521-1716	4 SWITCH, 1 12V	CENTER	RED

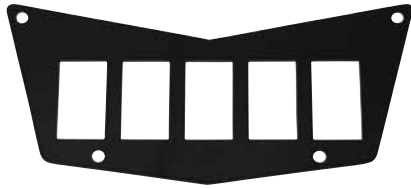

0521-1709

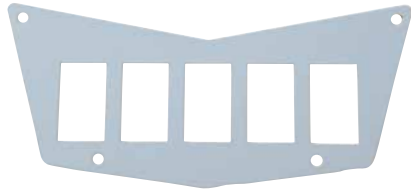

0521-1710

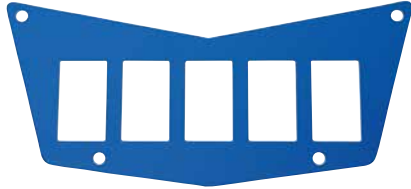

0521-1711



0521-1712



0521-1713



0521-1714



0521-1715



0521-1716



SMALL 4 SWITCH



LARGE 4 SWITCH | LARGE 4 SWITCH, 2 12V



5 SWITCH



4 SWITCH, 1 12V

PLOWS

WINCHES

UTV

RACKS

IMPLEMENTS & TOWING

LUGGAGE

BODY

CONTROLS

ELECTRICAL

WHEELS & TIRES

SUSPENSION & DRIVE

BRAKING

ENGINE

RIDER

GARAGE

PROMO

CAN-AM MAVERICK X3



POLARIS RZR



FRONT BUMPERS

Made from 44,5 mm (1 3/4") thick tube steel. Provides protection against branches, rocks and other obstacles. Features styling designed to complement the look of your UTV. Shown with black bumper guard. Bumper guards sold separately (see chart). Light bar not included.

BUMPER GUARDS

FITS MODEL	COLOR	PART #
CAN-AM		
MAVERICK XDS, XRS 17-18	BLACK	0530-1454
	BLUE	0530-1455
	RED	0530-1456
	YELLOW	0530-1457
POLARIS		
ALL RZR 900/1000 XP AND XP-4 15-18	BLACK	0530-1430
	BLUE	0530-1431
	RED	0530-1432
BUMPER GUARDS FOR RZR BUMPERS		
	BLACK	0530-1433
	BLUE	0530-1434
	RED	0530-1435



FRONT & REAR BULL BAR BUMPERS

Easy installation with direct to factory mounts. Available in factory-match colors. Durable powder-coat finish. Made from 50,8 mm (2") steel tubing.

FITS MODEL	COLOR	FRONT PART #	REAR PART #
POLARIS			
ALL RZR 900/1000 XP AND XP-4 15-18	BLACK	0530-1442	0530-1445
	BLUE	0530-1443	0530-1446
	RED	0530-1444	0530-1447

- PLOWES
- WINCHES
- UTV
- RACKS
- IMPLEMENTES & TOWING
- LUGGAGE
- BODY
- CONTROLS
- ELECTRICAL
- WHEELS & TIRES
- SUSPENSION & DRIVE
- BRAKING
- ENGINE
- RIDER
- GARAGE
- PROMO



WINCH MOUNT/BUMPER

Mount is made with high strength 7 gauge steel. 41,3 mm (1 5/8") steel tubing bumper design to protect the winch. Powder coated black for high durability. Easy installation ; winch not included. Made in the USA.

FITS MODEL	PART #
ARCTIC CAT	
WILDCAT 1000 (ALL)	0530-1437



POLARIS RZR FRONT UPPER DOOR BAG SET

Sold as a pair (left and right). Front knee pad. One large zippered storage area. Mounts using front factory door holes and included fasteners.

FITS MODEL	PART #
POLARIS	
POLARIS RZR 900S/XC, RZR 4 900, RZR XP 1000/TURBO, RZR XP4 1000/TURBO 14-18	3540-0023
REPLACEMENT PUSH PINS	3540-0024



UTV SPARE BELT MOUNT

Mount your spare UTV belt on your frame or roll cage. Fits belts 6,4 mm (1/4") to 12,7 mm (1/2") wide. Will not corrode. Includes foam pads for snug fit. Will not scratch frame or cage. No tool required for installation.

FITS MODEL	PART #
FITS ALL 44,5 MM (1 3/4") ROLL CAGES AND POLARIS RZR 900/1000	1142-0732
FITS ALL 50,8 MM (2") ROLL CAGES	1142-0733

REAR BUMPERS

Made from 44,5 mm (1 3/4") thick tube steel. Durable powder coated finish. Low profile design provides protection to the front and rear of the vehicle.

FITS MODEL	COLOR	PART #
POLARIS		
ALL RZR 900/1000 XP AND XP-4 15-18	BLACK	0530-1439
	BLUE	0530-1440
	RED	0530-1441

POLARIS RZR



CAN-AM MAVERICK X3



NERF BARS

Extremely durable steel 44,5 mm (1.75") tube nerf bars provide outstanding protection. In addition to the tough-looking design element, they retain the full stock ground clearance. Without hanging below the bottom of the vehicle, yet extending 127 mm (5"), they protect against obstacles without interfering with handling. Protects the chassis as well as the rear wheels. Mounts on the rocker panels of your UTV quickly and easily.

FITS MODEL	COLOR	PART #
CAN-AM		
MAVERICK X3, XDS, XRS 17-18	BLACK	0530-1448
	BLUE	0530-1449
	RED	0530-1450
	YELLOW	0530-1451
POLARIS		
RZR XP 900/1000 15-18	BLACK	0530-1424
	BLUE	0530-1425
	RED	0530-1426
RZR 4 900 15-18/RZR 4 1000 14-18/RZR 4 TURBO 16-18	BLACK	0530-1427
	BLUE	0530-1428
	RED	0530-1429





PLOWS

WINCHES

UTV

RACKS

IMPLEMENTS
& TOWING

LUGGAGE

BODY

CONTROLS

ELECTRICAL

WHEELS
& TIRES

SUSPENSION
& DRIVE

BRAKING

ENGINE

RIDER

GARAGE

PROMO



V-GRIP™ SINGLE

Variable Fit Technology provides a custom fit for guns, guns in a soft case and bows. Adjustable without tools. Bow limb slot keeps bows stable and is compatible with parallel limb designs. Suspension isolates shock and vibration for protection. Adjustable, low-profile bases provide a custom fit on tubular or composite racks. Gun not included.

DESCRIPTION	PART #
V-GRIP™ SINGLE	3518-0056



V-GRIP™ DOUBLE

Variable fit technology provides a custom fit for guns, guns in a soft case and bows. Adjustable without tools. Bow limb slot keeps bows stable and is compatible with parallel limb designs. Suspension isolates shock and vibration for protection. Adjustable, low-profile bases provide a custom fit on tubular or composite racks. Guns not included.

DESCRIPTION	PART #
V-GRIP™ DOUBLE	3518-0057



V-GRIP™ HANDLEBAR

Variable fit technology provides a custom fit for guns, guns in a soft case and bows. Adjustable without tools. Bow limb slot keeps bows stable and is compatible with parallel limb designs. Suspension isolates shock and vibration for protection. Adjustable, low-profile bases provide a custom fit on tubular or composite racks. Gun not included.

DESCRIPTION	PART #
V-GRIP™ HANDLEBAR	3518-0058



FLEXGRIP™ DOUBLE GUN RACK

The mounting base indexes into the Polaris Lock-N-Ride holes and comes with both UTV & ATV sizes. 15% larger forks for extended carrying capabilities. 360 degrees of rotation and amazing width adjustment or offset adjustment for the perfect fit every time. Guns not included.

DESCRIPTION	PART #
FLEXGRIP™ DOUBLE GUN RACK	3518-0063



FLEXGRIP™ SINGLE GUN RACK

The mounting base indexes into the Polaris Lock-N-Ride holes and comes with both UTV & ATV sizes. 15% larger forks for extended carrying capabilities. 360 degrees of rotation and amazing width adjustment or offset adjustment for the perfect fit every time. Guns not included.

DESCRIPTION	PART #
FLEXGRIP™ SINGLE GUN RACK	3518-0062





FLEXGRIP™ PRO-SINGLE

Features 15% larger forks for extended carrying capabilities. 360° of rotation and 40,5 cm (16") of width adjustment. Adjustable without tools. Variable fit technology provides a custom fit for guns, guns in a soft case and bows. Bow limb slot keeps bows stable and is compatible with parallel limb designs. Suspension isolates shock and vibration for protection. Adjustable, low-profile bases provide a custom fit on tubular or composite racks. Gun not included.

DESCRIPTION	PART #
FLEXGRIP™ PRO-SINGLE	3518-0054

FLEXGRIP™ PRO-DOUBLE

Features 15% larger forks for extended carrying capabilities. 360° of rotation and 40,5 cm (16") of width adjustment. Adjustable without tools. Variable fit technology provides a custom fit for guns, guns in a soft case and bows. Bow limb slot keeps bows stable and is compatible with parallel limb designs. Suspension isolates shock and vibration for protection. Adjustable, low-profile bases provide a custom fit on tubular or composite racks. Guns not included.

DESCRIPTION	PART #
FLEXGRIP™ PRO-DOUBLE	3518-0055



EXPEDITION SINGLE AND DOUBLE GUN RACK

Has soft rubber fins and extra rubber in the bottom to hold your gun securely. Patented fin design uses alternating long and short rubber fins that don't bind up and help cushion the gun. Aluminum blocks attach to handlebars or racks. Twist the fork and lock the wing nut for a tighter fit. Can also be mounted to front or rear rack. Gun not included.

DESCRIPTION	PART #
EXPEDITION SINGLE GUN RACK	3518-0029
EXPEDITION DOUBLE GUN RACK (NOT SHOWN)	3518-0130

RIDGETOP SINGLE GUN RACK

Uses internal steel forks covered with soft rubber to firmly hold guns. Soft rubber fins help provide superior shock absorption. Mounting base attaches to all ATVs and can be mounted to metal racks or flat cargo racks. Gun not included.

DESCRIPTION	PART #
RIDGETOP SINGLE GUN RACK	3518-0026



BIGHORN SINGLE GUN RACK

Rubber coated rack attaches to regular or flat cargo racks. Nylon core is flexible and the one piece design means no parts will vibrate loose. Patented offset design allows for more use of cargo space. Soft rubber spurs help hold items securely. Gun not included.

DESCRIPTION	PART #
BIGHORN SINGLE GUN RACK	3518-0030

AXIS DOUBLE GUN RACK

Easily carries two guns on an ATV. Rubber coated rack attaches to regular or flat cargo racks. Nylon core is flexible and the one piece design means no parts will vibrate loose. Patented offset design allows for more use of cargo space. Soft rubber spurs help hold items securely. Guns not included.

DESCRIPTION	PART #
AXIS DOUBLE GUN RACK	3518-0046

RACKS



OZARK DOUBLE GUN RACK

One of the most durable double ATV gun racks on the market. Utilizes high-quality components and a steel t-bar for extra strength. Easily carries two guns on an ATV. The rack can be rotated 360° allowing for a wide range of adjustments on any brand of ATV. Mounting base attaches to all ATVs and can be mounted to metal racks or flat cargo racks. Guns not included.

DESCRIPTION	PART #
OZARK DOUBLE GUN RACK	3518-0027



ELITE SERIES ATV CAM LOCK GRIP

Large design grabs guns, bows and handled objects. Quick and easy adjustment, custom fit. Snubber free design. Mounts to all tubular and composite ATV racks. Gun not included.

DESCRIPTION	PART #
ELITE SERIES ATV CAM LOCK GRIP	3518-0174



RIDGETOP CROSSBOW CARRIER

Soft rubber fins securely hold and cushion the crossbow. Carries crossbows with or without attached quivers. Support bars adjust for a custom fit. Master mounting blocks attach to railings and racks on most brands of ATVs. Crossbow not included.

DESCRIPTION	PART #
RIDGETOP CROSSBOW CARRIER	3518-0113



REPLACEMENT RUBBER SNUBBERS

Available for both styles of gun racks. Sold in pairs.

DESCRIPTION	PART #
ELITE SERIES UNIVERSAL SLIDE AND LOCK	3518-0176
FLEXGRIP™ AND V-GRIP™ GUN RACKS	3518-0059
OFFSET AND OLDER MOOSE GUN RACKS	3518-0031
FOR SINGLE AND DOUBLE GUN RACKS	3518-0178



GUN DEFENDER™ CASE

Injection molded design offers great strength and more water and dust resistance. Defender design accommodates standard and longer barreled guns. Additional width in the right places eliminates interferences with bolts and target style turrets. Hybrid interior structure allows customization and securely holds and protects guns.

GUN DEFENDER™ ATV UNIVERSAL MOUNT SYSTEM

Universal design fits nearly all makes and models of ATVs. Highly adjustable and customizable. Quickly and easily removable. Mounts one Gun Defender™ Transport System. Patent Pending.

What to order: Gun Defender™ Case and Universal Mount System

DESCRIPTION	PART #
GUN DEFENDER™ CASE	3518-0135
GUN DEFENDER™ ATV UNIVERSAL MOUNT SYSTEM	3518-0136



CHAINSAW HOLDER

The most versatile chainsaw holder on the market. Heavy-duty powder coated steel construction. Multi angle mounting. Equipped with a premium bar guard for maximum safety. Holds any model chainsaw with up to a 61 cm (24") bar. Chainsaw not included. Made in the USA.

DESCRIPTION	PART #
CHAINSAW HOLDER	1512-0133



ICE AUGER CARRIER

Fully adjustable and easy to use, this carrier mounts to the ATV's rack to keep the ice auger from rolling around and protects the blade's edge and the finish on your rack. Designed to transport safely and conveniently gas powered ice augers with up to 25.5 cm (10") diameter blades. Includes all mounting hardware. Auger not included. Made in the USA.

DESCRIPTION	PART #
ICE AUGER CARRIER	1512-0139



BACK REST

Framed from aircraft aluminum and the 50.8 mm (2") thick cushioned back is covered with high-density, waterproof, 400 denier nylon. Attaches to ATV rear cargo racks with u-bolts. Convenient adjustment feature to set the backrest at the desired position and angle. Folds flat for safe transport. Made in the USA.

DESCRIPTION	PART #
BACK REST	3550-0086

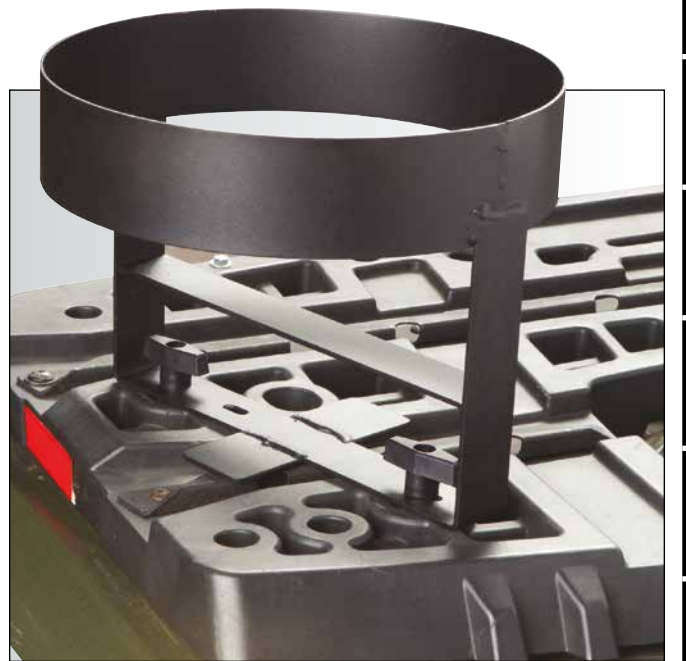

BUCKET BRACKET FOR POLARIS SPORTMAN

Allows for a simple, no spill transport of a 5-6 gallon plastic buckets for carrying your tools or gear. Mounts on the front or back of Polaris Sportman equipped with plastic front and rear gear platforms. Includes 2 Quick Detachable twist lock anchors. All steel welded and powder coated. Made in the USA.

DESCRIPTION	PART #
BUCKET BRACKET	1512-0168

PLOWS

WINCHES

UTV

RACKS

IMPLEMENTS
& TOWING

LUGGAGE

BODY

CONTROLS

ELECTRICAL

WHEELS
& TIRES

SUSPENSION
& DRIVE

BRAKING

ENGINE

RIDER

GARAGE

PROMO



UNIVERSAL REAR DROP RACK

Universal fit. Constructed of 19,1 mm (3/4") 18-gauge steel tubing. Measures 104 cm (41") L x 68,5 cm (27") W x 32,5 cm (12 3/4") D. Finished with a rubberized black powder coating. Mounting hardware included. **NOTE:** Never exceed manufacturers recommended weight capacity limits. Made in the USA.

DESCRIPTION	PART #
UNIVERSAL REAR DROP RACK	1512-0218



TOOL HOLDER

Securely holds all tools and other gear with standard 31,8 mm (1 1/4") inch diameter handles. Carries garden and ranch tools, fishing rods, and more. Shovel not included.

DESCRIPTION	PART #
TOOL HOLDER	1512-0046



VERTICAL TOOL HOLDER

Tool can be carried either horizontal or vertical. Carries shovels, rakes, hoes, and any other handled tools on your ATV. Shovel not included.

DESCRIPTION	PART #
VERTICAL TOOL HOLDER	1512-0047

HANDLEBAR & RACK ACCESSORY CLAMPS

Mount accessories to the rack or handlebars with these clamps. Mount, lights, mirrors, etc. Quick-release without tools. Sold each. Universal fit. Fits 19,1 mm (3/4") - 25,4 mm (1") tubing.

DESCRIPTION	PART #
HANDLEBAR & RACK ACCESSORY CLAMPS	4510-1174
ROLLBAR ACCESSORY CLAMPS	4510-1173



FRONT



REAR

UNIVERSAL FRONT AND REAR MESH RACKS

Made out of 19,1 mm (3/4") square 16-gauge tubing. 14-gauge diamond punched steel bottom and sides. Electro charged rubber coated finish for anti-rattling. Universal mounting hardware included. **NOTE:** Never exceed manufacturers recommended weight capacity limits. Made in the USA.

Front rack measures: 95 cm (37 3/8") W x 32,5 cm (12 3/4") L x 15 cm (6") D.
Rear rack measures: 103 cm (40 1/2") W x 57 cm (22 1/2") L x 15 cm (6") D.

DESCRIPTION	PART #
UNIVERSAL FRONT RACK	1512-0104
UNIVERSAL FRONT RACK WITH SLOT (FOR ATV'S WITH FRONT RAIL THAT STICKS UP)	1512-0105
UNIVERSAL REAR RACK	1512-0103



POLARIS SPORTSMAN REAR RACK

Sportsman "Flat Rack" is a simple drop and lock rack that fits 06-19 Polaris Sportsman rear plastic decks. Prior years require removal of the steel rail that attaches to the rear deck of the Sportsman. **NOTE:** Never exceed manufacturers recommended weight capacity limits. Made in the USA.

FITS MODEL	PART #
POLARIS SPORTSMAN 06-19 W/ REAR PLASTIC DECKS	1512-0174



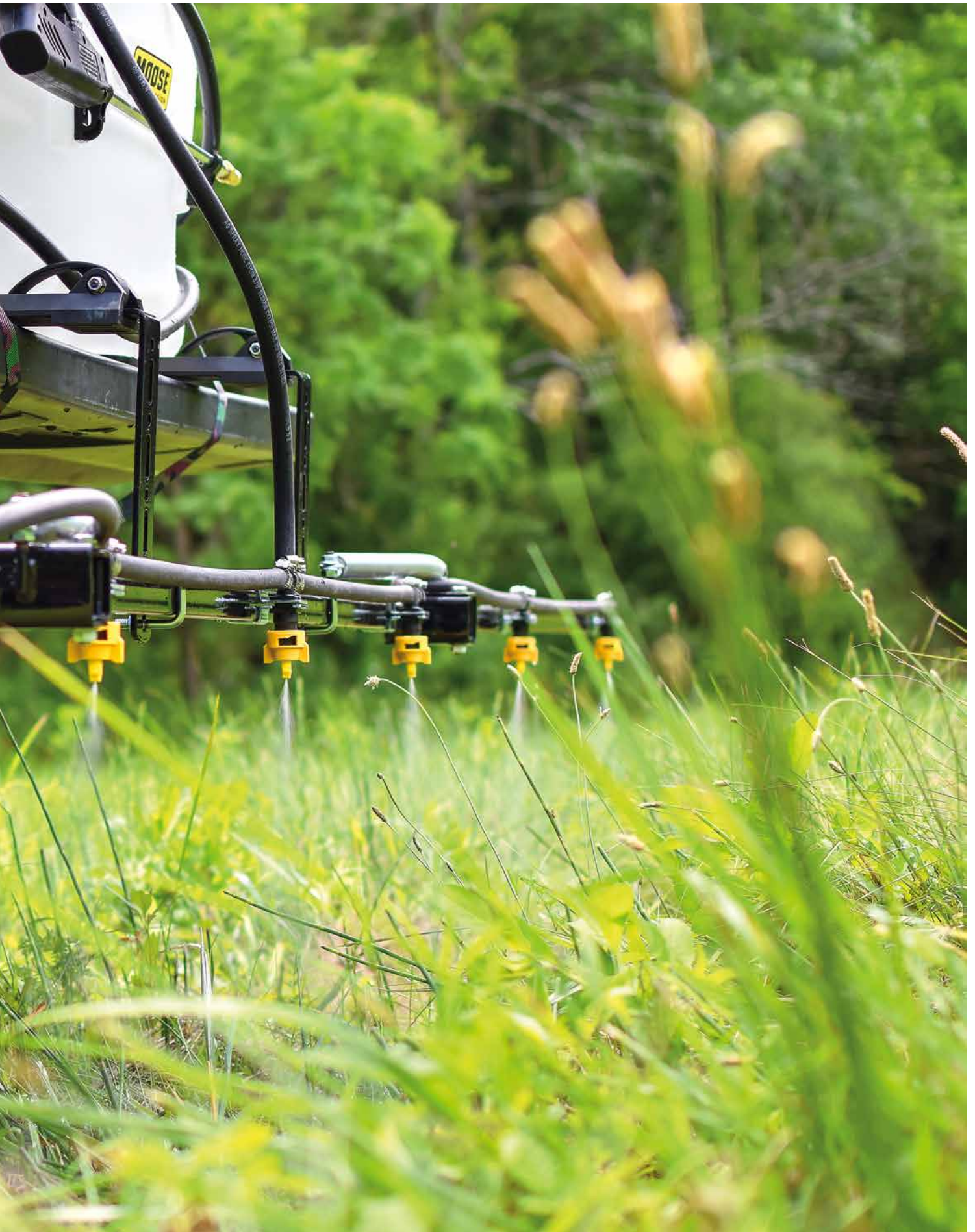



TRAILER SPRAYER

227 Liter (60 gallon) corrosion resistant polyethylene tank. 12 Volt diaphragm 14,4 lpm (3.8 gpm) high - flo pump -max. 3,0 bar (45 psi). Pressure gauge with adjustable pressure from 0-3,0 bar (0-45 psi). Deluxe handgun with pistol grip, adjustable nozzle and 7,6 m (25') of hose. Max. horizontal throw 10,6 m (35'). Max. vertical throw 8,0 m (26'). 7 Nozzle Boom with 356 cm (140") coverage. Tires: 4 ply 18 x 8.50 x 8. Some assembly required. Spare parts and replacements available on page 66. Made in the USA.

DESCRIPTION	PART #
TRAILER SPRAYER 227 L (60 GALLON) MSE	4503-0077



95 LITER (25 GALLON) SPOT SPRAYER

8 l/min. (2.1 GPM) High-Flo pump. 4 bar (60 psi). Corrosion resistant polyethylene tank. Full drain out capability with molded in drain port, cap and tether. 12,5 cm (5") fill lid with tether. Full length drain sump. Larger hose wrap horns for storage. Both gallon and liter fluid volume indicator on tank. Molded wand clips. On/Off switch, fuse, 244 cm (96") lead wire with quick disconnect included. Solid suction tube. Pistol grip handwand with adjustable pattern tip and 4,6 m (15') hose. Must use straps / tie-downs. Straps / tie-downs not included (pg. 240). Spare parts and replacements available on page 66. Made in the USA.

95 LITER (25 GALLON) DELUXE SPOT SPRAYER

14 l/min. (3.8 GPM) High-Flo pump. 3,1 bar (45 psi). "Y" valve for adjustable pressure and a glycerin filled pressure gauge. Corrosion resistant polyethylene tank. Lower tank profile for improved stability. Full drain out capability with molded in drain port, cap and tether. 12,5 cm (5") fill lid with tether. Full length drain sump. Larger hose wrap horns for storage. Both gallon and liter fluid volume indicator on tank. Molded wand clips. On/Off switch, fuse, 244 cm (96") lead wire with quick disconnect included. Solid suction tube. Pistol grip handwand with adjustable pattern tip and 4,6 m (15') hose. Must use straps / tie-downs. Straps/tie-downs not included (pg. 240). Spare parts and replacements available on page 66. Made in the USA.

DESCRIPTION	PART #
95 L (25 GALLON) 2.1 GPM SPOT SPRAYER	4503-0048
95 L (25 GALLON) DELUXE 3.8 GPM SPOT SPRAYER	4503-0049

NOTE: NEVER EXCEED MANUFACTURERS RECOMMENDED WEIGHT CAPACITY LIMITS.



151 LITER (40 GALLON) DELUXE SPOT SPRAYER

151 Liter (40 gallon) corrosion resistant polyethylene tank. 12 Volt diaphragm 8 l/min (2.1 gpm) high-flo pump 4.1 bar (60 psi) max. 2,4 m (8') wire harness with clips & on/off switch. Poly clips for handgun storage Deluxe handgun with adjustable pattern tip and 4,6 m (15') of hose. Max. horizontal throw - 10,6 m (35'). Max. vertical throw - 7,6 m (25') Ready for immediate use. Will not work with booms. Spare parts and replacements available on page 66. Made in the USA.

DESCRIPTION	PART #
151 L (40 GALLON) SPOT SPRAYER	4503-0063

NOTE: NEVER EXCEED MANUFACTURERS RECOMMENDED WEIGHT CAPACITY LIMITS.



57 LITER (15 GALLON) SPOT SPRAYER

4 l/min. (1 GPM) High-Flo pump. 2,4 bar (35 psi). Corrosion resistant polyethylene tank. Full drain out capability with molded in drain port, cap and tether. 12,5 cm (5") fill lid with tether. Full length drain sump. Larger hose wrap horns for storage. Both gallon and liter fluid volume indicator on tank. Molded wand clips. On/Off switch, fuse, 244 cm (96") lead wire with quick disconnect included. Solid suction tube. Standard 45,5 cm (18") handwand with adjustable pattern tip and 4,6 m (15') hose. No booms are available for this model. Must use straps / tie-downs. Straps/tie-downs not included (pg 240). Spare parts and replacements available on page 66. Made in the USA.

DESCRIPTION	PART #
57 L (15 GALLON) 1.0 GPM SPOT SPRAYER	4503-0047

NOTE: NEVER EXCEED MANUFACTURERS RECOMMENDED WEIGHT CAPACITY LIMITS.



REPLACEMENT PARTS

DESCRIPTION	PART #	DESCRIPTION	PART #
1.2 GPM HIGH-FLO	4503-0128	MANIFOLD (5302791)	4503-0126
2.4 GPM HIGH-FLO	4503-0129	SWIVEL BARB 10 MM (3/8")	4503-0089
4.5 GPM HIGH-FLO	4503-0130	SWIVEL NUT	4503-0078
SPRAYER WAND	4503-0056	GROMMET	4503-0080
PUMP 9,5 MM (3/8") FIT BARB	4503-0092	MACHINE SCREW 9,5 MM (3/8")	4503-0102
HANDGUN (PISTON GRIP)	4503-0056	MACHINE SCREW 25,4 MM (1")	4503-0103
HANDGUN (X-26 TIP)	4503-0076	MACHINE SCREW 63,5 MM (2.5")	4503-0104
HANDGUN CLIPS KIT	4503-0094	MACHINE SCREW 76,2 MM (3")	4503-0105
LEAD WIRE ASSEMBLY W/ SWITCH	4503-0067	BYPASS TUBE	4503-0116
TANK LID	4503-0086	CLAMP 9,5 MM - 12,7 MM (3/8"-1/2")	4503-0114
SIPHON TUBE	4503-0088	FIT BARB 9,5 MM (3/8")	4503-0121
DRAIN PLUG ASSEMBLY	4503-0093	FIT HOSE BARB 12,7 MM (1/2")	4503-0124
INLET SUB ASSEMBLY	4503-0096	HOSE BARB 9,5 MM (3/8")	4503-0125
INTAKE SUB ASSEMBLY	4503-0101	POLY HOSE 12,7 MM (1/2")	4503-0113
HOSE 12,7 MM X 122 CM (1/2" X 48")	4503-0082	PUMP SWITCHES	4503-0123
HOSE 9,5 MM X 18 CM (3/8" X 7")	4503-0085	REPL. RUBBER FEET (4-PK)	4503-0115
HOSE BYPASS	4503-0081	SHUT-OFF VALVE	4503-0118
HOSE WASHER	4503-0079	STRAINER WASHER 25,4 MM (1")	4503-0117
PRESSURE GAUGE	4503-0090	SWIVEL BARB 12,7 MM (1/2")	4503-0122
PRESSURE GAUGE (STAINLESS STEEL)	4503-0091	SWIVEL SHUT-OFF TAP	4503-0119
MANIFOLD (5275516)	4503-0097	TURN CAP	4503-0120
MANIFOLD (5275517)	4503-0098		



3 NOZZLE "BOOMLESS" KIT

3 Nozzle Boom. 76 cm (30") of spray coverage. Specially designed nozzles each have individual shut off's, and check valves, includes fittings to connect to most sprayers. Will only work with the 94.64 liter (25 gallon) 3.8 sprayer systems. Nozzles can be adjusted to spray right, left, center or all three. Nozzles can also be adjusted up or down depending on spray needs. Additional spare parts and replacements available on page 66. Made in the USA.

DESCRIPTION	PART #
76 CM (30") NOZZLE "BOOMLESS" KIT	4503-0075
SPARE NOZZLE ASSEMBLY	4503-0095
SPARE SUB ASSEMBLY	4503-0099

NOTE: NEVER EXCEED MANUFACTURERS RECOMMENDED WEIGHT CAPACITY LIMITS.



DESCRIPTION	PART #
7 NOZZLE 356 CM (140") BOOM KIT	4503-0074
SPARE CENTER NOZZLE (10 MM TUBING)	4503-0106
SPARE CENTER NOZZLE (12 MM TUBING)	4503-0068
SPARE END NOZZLE (10 MM TUBING)	4503-0107
SPARE END NOZZLE (12 MM TUBING)	4503-0069

7 NOZZLE BOOM KIT

7 Nozzle Boom. 356 cm (140") coverage. 3 section folding boom. Includes fittings to connect to most spot sprayers. Will not work with the 57 Liter (1.5 Gal.) 4 l/min (1 GPM) model. Additional spare parts and replacements available on page 66. Made in the USA.



5 NOZZLE BOOM KIT

5 Nozzle Boom. 254 cm (100") coverage. Fold behind boom. Includes fittings to connect to most spot sprayers. Will not work with the 57 l (1.5 Gal.) 4 l/min. (1 GPM) model. Additional spare parts and replacements available on page 66. Made in the USA

DESCRIPTION	PART #
5 NOZZLE 254 CM (100") BOOM KIT	4503-0073
SPARE CENTER NOZZLE (10 MM TUBING)	4503-0106
SPARE CENTER NOZZLE (12 MM TUBING)	4503-0068
SPARE END NOZZLE (10 MM TUBING)	4503-0107
SPARE END NOZZLE (12 MM TUBING)	4503-0069





SPREADER

Spreads everything from seed, dry granular fertilizers, pesticides and ice melting materials. 62 l (2.2 cubic feet) poly hopper. 12 volt motor with variable speed control and on/off switch. Variable speed control allows you to vary spread width from 1,5 m to 13,7 m (5 to 45 feet). Material agitator and stainless steel radial 6-blade fan. Holds up to 66 kg (145 lbs). Not for use with sand. Mounting hardware included. Made in USA.

DESCRIPTION	PART #
SPREADER	4503-0057
SPREADER COVER	4503-0058

NOTE: NEVER EXCEED MANUFACTURERS RECOMMENDED WEIGHT CAPACITY LIMITS.

REPLACEMENT PARTS	PART #	REPLACEMENT PARTS	PART #
MOTOR	4503-0046	GATE STOP	4503-0111
CONTROLLER	4503-0062	FLAT WASHER 6,4 MM (1/4")	4503-0110
SPINNER	4503-0065	WASHER 6,4 MM (1/4")	4503-0109
SAFETY STRAP	4503-0066	WING NUT 6,4 MM (1/4")	4503-0108
GATE SLIDE	4503-0112	MOTOR SPINDLE	4503-0127



SPREADER RECIEVER HITCHES

Adapt the Moose spreader (part # 4503-0057) onto any vehicle with a 50,8 mm (2") or 31,8 mm (1-1/4") receiver box. Spreader not included. Made in the USA.

DESCRIPTION	PART #
50,8 MM (2")	4503-0060
31,8 MM (1-1/4")	4503-0061



PROMO
GARAGE
RIDER
ENGINE
BRAKING
SUSPENSION & DRIVE
WHEELS & TIRES
ELECTRICAL
CONTROLS
BODY
LUGGAGE
IMPLEMENTS & TOWING
RACKS
UTV
WINCHES
PLOWS



FLATBED TRAILER

Designed to be towed behind an ATV. Expanded metal flatbed (86 cm x 122 cm) with a 16-gauge steel frame. 453 kg (1000 lb.) load capacity. Deck tilts to dump load by removing one cotter pin. 45,5 cm (18") ATV wheels with roller bearings 25,4 mm (1") steel axle. Black powder-coat finish resists rust. Hitch pin included.

DESCRIPTION	PART #
FLATBED TRAILER	4504-0125



UTILITY TRAILER

18-gauge steel construction. 280 L (10 cubic feet) capacity trailer has 450 kg weight limit. Oil lube roller bearings grease fittings for easy lubrication. 4.00 x 8 pneumatic tires. Features removable tailgate, dump bed. Hitch pin included. Made in USA. Body measures: 76 cm (30") L x 122 cm (48") W x 30,5 cm (12") H. Wheels: 16 x 6.5 x 8

DESCRIPTION	PART #
UTILITY TRAILER	M92-21041



SWIVEL DUMP TRAILER

354 Liter (12,5 cubic feet) heaped capacity .565 kg (1250 lb) load capacity. Structural foam cart body will not rust. Pass-through undercarriage provides a full 30,5 cm (12") of ground clearance. Pivoting hitch allows cart to adjust to uneven terrain. Full 60° dump angle. Cart body swivels to easily dump load anywhere within a 100° radius. Works with a 47,6 mm (1-7/8") ball. Foot pedal activates dump mechanism ATV/UTV/Tractor compatible. Tires - 40,5 cm (16") x 19 cm (7.5") x 20,5 cm (8"). Overall length - 193,5 cm (76.26") L x 119 cm (46.77") W x 79 cm (31.12") H. Box length - 122 cm (48") L x 102 cm (40") W x 37 cm (14.5") H. Assembly required. Made in U.S.A.

DESCRIPTION	PART #
SWIVEL DUMP TRAILER	4504-0099
WHEEL REPLACEMENT	4504-0119
SPARE SPACER	4504-0120
SPARE WASHER	4504-0121



BALL HITCH CONVERSION KIT

Converts Utility Trailer part # M92-21041 from pin hitch to a ball hitch (for other brands drilling may be required). Powder coated steel connector bracket with galvanized steel coupler. Comes complete with necessary hardware to bolt to cart drawbar. Fits 47,6 mm (1-7/8") trailer ball (coupler included). Made in the USA.

DESCRIPTION	PART #
BALL HITCH CONVERSION KIT	4504-0036



TUB SLED & TOW BAR

Molded and measures 142 cm (56") L x 66 cm (26") W x 24 cm (9.5") H. Add the tow bar to tow behind your snowmobile or ATV/UTV. Ribbed bottom excellent for tracking. Tow bar sold separately. Made in the USA.

DESCRIPTION	PART #
TUB	4503-0070
TOW BAR	4503-0071



HITCH BALL NOT INCLUDED

3-WAY HITCH

Mounts quickly and easily to any ATVs equipped with factory hitch. Use hitch ball/clevis pin without changing hitches. Tow loop, perfect anchor point for pulling with tow strap/winch cable. Includes 19,1 cm (¾") hardened mounting bolt.

DESCRIPTION	PART #
3-WAY HITCH	M92-41100



HITCH BALL NOT INCLUDED

3-WAY COMPACT HITCH

Use ball, pin pull, or tow loop without changing hitches. Versatile-handles your hauling/towing needs. Fits ATVs that accept a trailer ball. Mounting hardware included.

DESCRIPTION	PART #
3-WAY COMPACT HITCH	4504-0098



HITCH BALL NOT INCLUDED

3-WAY 50,8 MM (2") RECEIVER HITCH

Gives you the option of using a ball or clevis pin mount. The reversible drop hitch bar is secured by a 15,9 mm (5/8") hitch pin with a cotter key and can be quickly removed. The hitch collar mounts to any ATV with a factory hitch. Utilizes standard 50,8 mm (2") hitch box. Tow, pull or use a pin hitch without changing hitches. Insert is reversible for trailer hitch height adjustment. Made in the USA.

DESCRIPTION	PART #
3-WAY 50,8 MM (2") RECEIVER HITCH	4504-0102



HITCH BALL NOT INCLUDED

3-WAY 31,8 MM (1 1/4") RECEIVER HITCH

Use ball or clevis mount without changing hitches. Reversible drop hitch bar secured by 15,9 mm (5/8") hitch pin. Hitch collar mounts to ATV with factory hitch. Uses standard 31,8 mm (1 1/4") hitch box; insert reversible for trailer hitch height adjustment. Mounting hardware included. Made in the USA.

DESCRIPTION	PART #
3-WAY 31,8 MM (1 1/4") RECEIVER HITCH	4504-0103

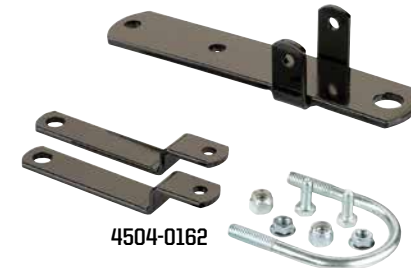

4504-0162

TRAILER HITCHES

Heavy-duty steel and powder coated for durability. Fixture welded for precise fit. Mounting hardware and instructions included. Made in the USA.

FITS MODEL	PART #
ARCTIC CAT	
DVX400 2X4 04-12	4504-0159
HONDA	
TRX250EX/250X 01-17	4504-0167
TRX250X 87-92	4504-0168
TRX250 RECON 97-16	4504-0169
TRX300EX 93-07	4504-0168
TRX400EX/400X 99-13	4504-0166
TRX450R 05-07	4504-0166
TRX650/680 RINCON 03-19	4504-0160
KAWASAKI	
KFX400 04-12	4504-0159
KVF650/700 PRAIRIE 4X4 02-04	4504-0165
KFX700 04-09	4504-0165
MULE 610 05-16	4504-0172
MULE SX XC 4X4 17-19	4504-0172
MULE SX 4X4 17-19	4504-0172
POLARIS	
ALL SCRAMBLER, SPORT, TRAILBLAZER 96-11	4504-0170
SUZUKI	
LITZ250 04-09	4504-0171
OZARK 250 02-12	4504-0171
LITZ400 04-12	4504-0159
YAMAHA	
YFA1 125 BREEZE 89-03	4504-0162
GRIZZLY 125 2X4 05-13	4504-0162
WOLVERINE 350 06-10	4504-0161
RAPTOR 350 04-07	4504-0163
YFM350FX WOLVERINE 95-05	4504-0164
YFM350 WARRIOR 89-03	4504-0163
WOLVERINE 450 4X4 06-10	4504-0161



31,8 MM (1 1/4") TO 50,8 MM (2") HITCH ADAPTER

Adapt your existing 31,8 mm (1 1/4") receiver so you can use your 50,8 mm (2") hitch accessories. 31,8 mm (1 1/4") outside male end to 50,8 mm (2") female inside. Welded D-ring for trailer tie-down or tow point. Includes 12,7 mm (½") hitch pin and hairpin cotter pin. Black powder coated finish. Made in the USA.

DESCRIPTION	PART #
31,8 MM 1 1/4" TO 50,8 MM (2") HITCH ADAPTER	4504-0101



TRIO HD HITCHES

Welded-on 50,8 mm (2") ball on a 76,2 mm (3") rise. Reinforced tow loop/tie-down point and clevis pin hole. Quiet Tek wedge reduces hitch rattle. Trio Receiver accepts standard accessories. Patent pending "C" channel design guarantees maximum strength and provides a 76,2 mm (3") rise for optimal towing height. Mounting hardware and hitch pin included.

DESCRIPTION	PART #
TRIO HD 38,1 MM (1 1/2") HITCH W/ BALL MOUNT	4504-0060
TRIO HD 50,8 MM (2") HITCH W/ BALL MOUNT	4504-0059
TRIO HD RECEIVER HITCH W/ BALL MOUNT	4504-0058
TRIO HD MULTI-PURPOSE HITCH W/ BALL MOUNT	4504-0061
HITCH TRIO 50MM BALL 1.25	4504-0174
HITCH TRIO 50MM BALL 2.0	4504-0175

IMPLEMENTS & TOWING



4504-0130



4504-0132

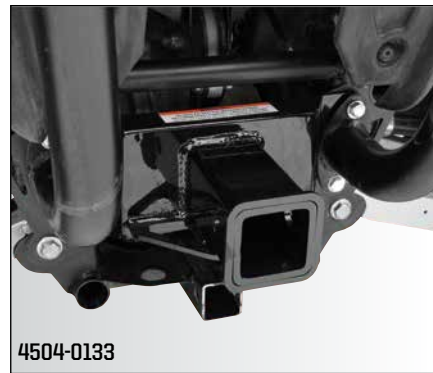

4504-0133



4504-0134



4504-0136



4504-0138



4504-0139



4504-0140

REAR RECEIVER HITCHES

50,8 mm (2") receiver hitches are frame mounted with a durable powder-coated finish. Provides heavy towing capabilities. Made in the USA.

FITS MODEL	PART #
REAR RECEIVER HITCHES	
CAN-AM	
OUTLANDER 400 13-15	4504-0140
RENEGADE 500/800 07-11	4504-0140
OUTLANDER (ALL, EXCEPT 12 800R) 06-12	4504-0140
OUTLANDER 450L / 450L MAX 15-19	4504-0131
OUTLANDER 450 17-19	4504-0131
OUTLANDER 500L 15	4504-0131
OUTLANDER 570 XT / MAX XT 17-19	4504-0131
OUTLANDER 570L / MR-X / MAX 16-19	4504-0131
RENEGADE 570 / X MR 17-19	4504-0131
RENEGADE 850 18-19	4504-0131
RENEGADE 1000 15-19	4504-0131
RENEGADE 1000 X MR 17-19	4504-0131
MAVERICK 1000 15	4504-0148
HONDA	
RECON 250 97-17	4504-0142
RANCHER 350 00-06	4504-0143
RANCHER 420 AT (IND. SUSP) 09-18	4504-0141
RANCHER 420 (STRAIGHT AXLE) 07-18	4504-0143
FOREMAN 500 05-17	4504-0143
RUBICON 500 05-14	4504-0143
RUBICON 500 15-18	4504-0141

FITS MODEL	PART #
REAR RECEIVER HITCHES (CON'T)	
HONDA (CON'T)	
RINCON 650/680 03-16	4504-0138
PIONEER 500 15-18	4504-0146
KAWASAKI	
BRUTE FORCE 650L/750L (IND SUSP ONLY) 05-17	4504-0132
MULE 610 05-16	4504-0135
MULE SX XC 4X4 17	4504-0135
MULE SX 4X4 17	4504-0135
POLARIS	
ALL SPORTSMAN W/IND. SUSPENSION (EXCEPT XP, X2, TOURING) 96-14	
SPORTSMAN 450 HD 16-19	4504-0139 ¹
SPORTSMAN 570 & SP 15-19	4504-0139
SPORTSMAN 570 TOURING 15-19	4504-0139
SPORTSMAN 570 X2 16-17	4504-0139
SPORTSMAN 570 X2 15	4504-0130
SPORTSMAN 850 HIGH LIFTER 16	4504-0130
SCRAMBLER 850 13-16	4504-0130
SPORTSMAN 850 HD 17	4504-0130
SPORTSMAN 850 SP 15-17	4504-0130
SPORTSMAN XP 550/850 10-15	4504-0130
SPORTSMAN TOURING/X2 550/850 11-16	4504-0130
SPORTSMAN 1000 XP 18-19	4504-0130
SPORTSMAN 1000 15-16	4504-0130
SCRAMBLER 1000XP 15-17	4504-0130
SPORTSMAN ETX 15	4504-0139

FITS MODEL	PART #
REAR RECEIVER HITCHES (CON'T)	
POLARIS (CON'T)	
RZR 570 - S EPS 17	4504-0106
RZR 570 / TRAIL 16	4504-0106
RZR 800 / RZR S / RZR 4 08-14	4504-0133
ACE 900 16	4504-0106
RZR 900 TRAIL 18	4504-0115
RZR XC 900 / 900S 15-19	4504-0115
RZR XP 1000 EPS 17	4504-0144
RZR 1000 XP-4 TURBO 16	4504-0144
RZR 1000 TURBO 17	4504-0144
RZR 1000 / RZR-4 1000 14-17	4504-0144
RZR-S 1000 16-19	4504-0115
SUZUKI	
KING QUAD 450/500/700/750 AXI 05-17	4504-0134
YAMAHA	
GRIZZLY/BIG BEAR 350/400 IRS 07-12	4504-0137
KODIAK 450 18	4504-0137
GRIZZLY 450 IRS 11-14	4504-0137
GRIZZLY 550 09-15	4504-0136
GRIZZLY 700 07-19	4504-0136
KODIAK 700 16-19	4504-0136

¹ WILL NOT FIT 2005 MODELS & 08-12 SPORTSMAN 300/400, SPORTSMAN XP, OR X2/TOURING MODELS



4504-0153

FRONT RECEIVER HITCHES

Thick steel construction with a strong receiver tube for superior towing power. Reinforced trim ring for that truck hitch look and increased strength. Works with all standard 50.8 mm (2") drawbars. Solid frame mounting using existing attachment points, no drilling required. Includes all hardware and complete instructions. Cutting the front plastic pan required on all models except Ranger and King Quad. Not for use with receiver mounted plows. Made in the USA.

FITS MODEL	PART #
FRONT RECEIVER HITCHES	
CAN-AM	
OUTLANDER (ALL, EXCEPT 800R/1000R 12) 06-12	4504-0117
HONDA	
RANCHER 420 AT (IND. SUSP) 15-17	4504-0107
FOREMAN RUBICON 500 15-18	4504-0107
FOREMAN 500 (STRAIGHT AXLE) 14,16-17	4504-0107
KAWASAKI	
BRUTE FORCE 650I (IND SUSP ONLY) 11-12	4504-0153
BRUTE FORCE 750 08-17	4504-0153
MULE 610 05-16	4504-0152

FITS MODEL	PART #
FRONT RECEIVER HITCHES (CON'T)	
POLARIS	
RANGER 700 (EXCEPT CREW & 6X6) 09	4504-0097
RANGER 800 10-13	4504-0097
RANGER DIESEL 11-13	4504-0097
YAMAHA	
GRIZZLY 700 07-15	4504-0096
GRIZZLY/KODIAK 700 16-18	4504-0151







PLOWS

WINCHES

UTV

RACKS

IMPLEMENTS
& TOWING

LUGGAGE

BODY

CONTROLS

ELECTRICAL

WHEELS
& TIRES

SUSPENSION
& DRIVE

BRAKING

ENGINE

RIDER

GARAGE

PROMO



OZARK REAR RACK BAG

Rigid bag mounts easily to your ATV's rear rack. Zippered top flap provides access to large storage compartment. High-density foam seat pad integrated into bag. Do not use as seat while riding. Movable, internal dividers, key clip and zippered mesh pockets provide plenty of ways to store cargo. Four outside pockets. Internal mesh pockets, one with security zipper, help organize cargo. External, mesh storage pockets allow easy access to favorites (drink bottle, tools, etc). The finest materials create a rugged, water-resistant fabric case which resists the elements and cleans up easily with a damp cloth. 91 cm (36") L x 48,5 cm (19") W x 20,5 cm (8") H.

DESCRIPTION	PART #
BLACK	3505-0212



RIDGETOP REAR RACK BAG

Rigid bag mounts easily to your ATV's rear rack. Zippered top flap provides access to large storage compartment. High-density foam seat pad integrated into bag. Do not use as seat while riding. Movable, internal dividers, key clip and two zippered mesh pockets provide plenty of ways to store and protect cargo. External shotgun shell holder (holds more than 15 shells), and a handy tool holder, puts what you need at your fingertips. External, mesh storage pockets permit easy access to favorites (drink bottle, tools, etc). The finest materials combine to create a rugged, water-resistant fabric case which resists the elements and cleans up easily with a damp cloth. 94 cm (37") L x 48,5 cm (19") W x 30,5 cm (12") H.

DESCRIPTION	PART #
BLACK	3505-0214



PLOWS

WINCHES

UTV

RACKS

IMPLEMENTS
& TOWING

LUGGAGE

BODY

CONTROLS

ELECTRICAL

WHEELS
& TIRES

SUSPENSION
& DRIVE

BRAKING

ENGINE

RIDER

GARAGE

PROMO



BIGHORN FENDER BAG

Form-fitting bag mounts easily to your ATV's rack and fenders. Zippered storage compartments with weather-resistant flaps. Internal mesh storage pocket and key clip. Exterior, elastic mesh storage pocket permits easy access to contents. The finest materials combine to create a rugged, water-resistant fabric case which resists the elements and cleans up easily with a damp cloth. Bags are attached to each other and cannot be used separately.

Top: 18 cm (7") L x 15 cm (6") W x 64 mm (2 1/2") H. Bottom: 30,5 cm (12") L x 18 cm (7") W x 64 mm (2 1/2") - 89 mm (3 1/2") H.

DESCRIPTION	PART #
BLACK	3509-0024



PROSPECTOR FRONT STORAGE TRUNK

Made from easy to clean, high impact-resistant polyethylene. UV stabilized. Comes equipped with locking latches and side reflectors. Secured with either quick-release tie downs or u-bolts for permanent mounting. Top versatile storage area with foam hand grips. Measures 84 cm (33") L x 43 cm (17") W x 20,5 cm (8") H.

DESCRIPTION	PART #
PROSPECTOR FRONT STORAGE TRUNK	3505-0006
REPLACEMENT LATCH KIT	3550-0223

NOTE: NEVER EXCEED MANUFACTURERS RECOMMENDED WEIGHT CAPACITY LIMITS.



FRONT AND REAR ALUMINUM BOXES

Black powder-coated, diamond plate aluminum. Black stainless steel, lockable latches. Lids include gas-mounted shocks and weather stripping. Drain holes provide air circulation and easy cleaning. Includes an anti-slip mat. Some drilling required. Front measures: 82,5 cm (32 1/2") L x 32,5 cm (12 3/4") W x 16,5 cm (6 1/2") H. Rear measures 81 cm (32") L x 35,5 cm (14") W x 36 cm (14 1/4") H. Made in the USA.

DESCRIPTION	PART #
FRONT ALUMINUM BOX	3505-0047
REAR ALUMINUM BOX	3505-0048

NOTE: NEVER EXCEED MANUFACTURERS RECOMMENDED WEIGHT CAPACITY LIMITS.



HELMET REAR STORAGE TRUNK

Rear storage compartment will accommodate two helmets or other large items (nearly 3.5 cubic feet). Quick-access drink holders built into the side. Center area allows more space for relaxing while stopped. Not for use as a seat while riding. Two draw-tight latches secure the lid. Mounts directly to tubular and composite racks using four U-bolts and sealing washers. Rugged roto-molded design. Dimensions: 94 cm (37") W x 63,5 cm (25") D x 43 cm (17") H. Helmets not included. Made in the USA.

DESCRIPTION	PART #
HELMET REAR STORAGE TRUNK	3505-0206
REPLACEMENT LATCH KIT	3550-0188

NOTE: NEVER EXCEED MANUFACTURERS RECOMMENDED WEIGHT CAPACITY LIMITS.



TWO TIER FRONT STORAGE TRUNK

Top level is perfect for smaller items and the bottom level will accommodate larger gear complete with two padlock latches. Double-wall lids provide maximum rigidity. Single-wall body allows for maximum storage capacity. Rugged roto-molded design. Dimensions: 76 cm (30") W x 32,5 cm (12 3/4") D x 28 cm (11") H. Made in the USA.

DESCRIPTION	PART #
TWO TIER FRONT STORAGE TRUNK	3505-0207
REPLACEMENT LATCH KIT	3550-0188

NOTE: NEVER EXCEED MANUFACTURERS RECOMMENDED WEIGHT CAPACITY LIMITS.



TWO TIER REAR STORAGE TRUNK

Top level is perfect for smaller items and the bottom level will accommodate larger gear complete with two padlock latches. Double-wall lids provide maximum rigidity. Single-wall body allows for maximum storage capacity. Rugged roto-molded design. Dimensions: 94 cm (37") W x 42,5 cm (16 3/4") D x 42,5 cm (16 3/4") H. Made in the USA.

DESCRIPTION	PART #
TWO TIER REAR STORAGE TRUNK	3505-0208
REPLACEMENT LATCH KIT	3550-0188

NOTE: NEVER EXCEED MANUFACTURERS RECOMMENDED WEIGHT CAPACITY LIMITS.

PLOWS

WINCHES

UTV

RACKS

IMPLEMENTS & TOWING

LUGGAGE

BODY

CONTROLS

ELECTRICAL

WHEELS & TIRES

SUSPENSION & DRIVE

BRAKING

ENGINE

RIDER

GARAGE

PROMO

LUGGAGE



DIPLOMAT STORAGE TRUNK

Made from easy to clean, high impact-resistant polyethylene. UV stabilized. Center area allows more space for relaxing while stopped. Not for use as a seat while riding. Fits most ATVs. Mounts with U-bolts. Measures 107,5 cm (42 1/4") L x 63,5 cm (25") W x 45,5 cm (18") H. Seat size 59,5 cm (23 1/2") L x 38,5 cm (15 1/4") W x 76 mm (3") H.

DESCRIPTION	PART #
DIPLOMAT STORAGE TRUNK	3505-0031
REPLACEMENT LATCH KIT	3550-0223

NOTE: NEVER EXCEED MANUFACTURERS RECOMMENDED WEIGHT CAPACITY LIMITS.



EXPLORER STORAGE TRUNK

Made from easy to clean, high impact-resistant polyethylene. UV stabilized. Large 30,5 cm (12") opening will fit most chain saws, helmets etc. Urethane molded back pad. U-bolts for permanent mounting and 6 quick release tie-down straps for temporary mounting. Measures 94 cm (37") L x 58,5 cm (23") W x 45,5 cm (18") H.

DESCRIPTION	PART #
EXPLORER STORAGE TRUNK	MUDT30
REPLACEMENT LATCH KIT	3550-0223

NOTE: NEVER EXCEED MANUFACTURERS RECOMMENDED WEIGHT CAPACITY LIMITS.



DIPLOMAT II STORAGE TRUNK

Made from easy to clean, high-impact resistant polyethylene. UV stabilized. Black leather arm and back rests and a 76 mm (3") thick base cushion. Other features include: locking latches, reflectors, foam hand grips. Center area allows more space for relaxing while stopped. Not for use as seat while riding. U-bolts used for mounting. Can be adapted to most types of ATVs. Measures 104 cm (41") L x 63,5 cm (25") W x 42 cm (16 1/2") H.

DESCRIPTION	PART #
DIPLOMAT II STORAGE TRUNK	3505-0204

NOTE: NEVER EXCEED MANUFACTURERS RECOMMENDED WEIGHT CAPACITY LIMITS.

DYNASTY STORAGE TRUNK

Made from easy to clean, high-impact resistant polyethylene. UV stabilized. Black leather arm and back rests and a 76 mm (3") thick base cushion. Other features include: locking latches, reflectors, foam hand grips. Center area allows more space for relaxing while stopped. Not for use as seat while riding. U-bolts used for mounting. Can be adapted to most types of ATVs. Measures 100,5 cm (39.5") L x 61 cm (24") W x 43 cm (17") H.

DESCRIPTION	PART #
DYNASTY STORAGE TRUNK	3505-0203

NOTE: NEVER EXCEED MANUFACTURERS RECOMMENDED WEIGHT CAPACITY LIMITS.



REAR STORAGE TRUNK

Manufactured from black LLDPE (linear low-density polyethylene). Rugged, rotational-molded construction. Single wall base allows for maximum storage space. Double wall lid provides additional durability. Includes a single, centered reflector. Includes two, key-lockable latches. Measures 94 cm (37") W x 43 cm (17") D x 37 cm (14 1/2") H. Made in the USA.

DESCRIPTION	PART #
REAR STORAGE TRUNK	3505-0210
REPLACEMENT LATCH KIT	3550-0188

NOTE: NEVER EXCEED MANUFACTURERS RECOMMENDED WEIGHT CAPACITY LIMITS.

FRONT STORAGE TRUNK

Manufactured from black LLDPE (linear low-density polyethylene). Rugged, rotational-molded construction. Single wall base allows for maximum storage space. Double wall lid provides additional durability. Includes two, key-lockable latches. Measures 76 cm (30") W x 33 cm (13") D x 25,5 cm (10") H. Made in the USA.

DESCRIPTION	PART #
FRONT STORAGE TRUNK	3505-0209
REPLACEMENT LATCH KIT	3550-0188

NOTE: NEVER EXCEED MANUFACTURERS RECOMMENDED WEIGHT CAPACITY LIMITS.



EXECUTIVE STORAGE TRUNK

Made from easy to clean, high impact resistant polyethylene. Center storage compartment removes and allows more space for relaxing while stopped. Not for use as a seat while riding. UV stabilized. Fits most ATVs. Mounts with U-bolts. Measures 90 cm (35 1/2") L x 39,5 cm (15 1/2") W x 38 cm (15") H. Seat size 39,5 cm (15 1/2") L x 53,5 cm (21") W x 76 mm (3") H.

DESCRIPTION	PART #
EXECUTIVE STORAGE TRUNK	MUDT10

NOTE: NEVER EXCEED MANUFACTURERS RECOMMENDED WEIGHT CAPACITY LIMITS.

PROMO
GARAGE
RIDER
ENGINE
BRAKING
SUSPENSION & DRIVE
WHEELS & TIRES
ELECTRICAL
CONTROLS
BODY
LUGGAGE
IMPLEMENTS & TOWING
RACKS
UTV
WINCHES
PLOWES

LUGGAGE

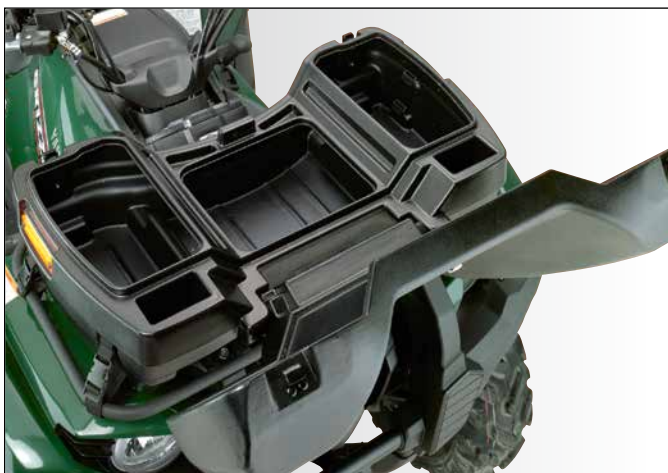

FORESTER STORAGE TRUNK

Made from easy to clean, high-impact resistant polyethylene. UV stabilized. Built in enclosure to store cans. Lockable latches. Fits most ATVs and includes U-bolts for mounting. Measures 81 cm (32") L x 45,5 cm (18") W x 28 cm (11") D.

DESCRIPTION	PART #
FORESTER STORAGE TRUNK	3505-0132
REPLACEMENT LATCH KIT	3550-0223
REPLACEMENT LOCK KIT	3550-0224

NOTE: NEVER EXCEED MANUFACTURERS RECOMMENDED WEIGHT CAPACITY LIMITS.

REAR STORAGE TRUNK W/COOLER

Provides 64 mm (2 1/2) cubic feet of weather resistant storage. Center area allows more space for relaxing while stopped. Not for use as a seat while riding. Convenient rear cooler compartment with removable drain plug. Mounts to most tubular or composite racks using four U-bolts and sealing washers. Rugged roto-molded design. Dimensions: 101 cm (39 3/4") W x 71 cm (27 7/8") D x 43 cm (17") H. Cooler Dimensions: 33 cm (13" W) x 10 cm (4") D x 16,5 cm (6 1/2") H. Made in the USA.

DESCRIPTION	PART #
REAR STORAGE TRUNK W/COOLER	3505-0211

NOTE: NEVER EXCEED MANUFACTURERS RECOMMENDED WEIGHT CAPACITY LIMITS.



3505-0023



3505-0024

FRONT AND REAR CARGO BOXES

Durable polyethylene with UV stabilizers. Rubber seal keeps water and dust out. Comes with necessary hardware, lockable latches and durable molded-in hinges.

Front measures 86 cm (34") L x 45,5 cm (18") W x 20,5 cm (8") H, 2,26 cubic feet capacity. Rear measures 117 cm (46") L x 58,5 cm (23") W x 30,5 cm (12") H, 4,2 cubic feet capacity. Made in the USA.

DESCRIPTION	PART #
FRONT CARGO BOX	3505-0023
REAR CARGO BOX	3505-0024
REPLACEMENT LATCH KIT	3550-0190

NOTE: NEVER EXCEED MANUFACTURERS RECOMMENDED WEIGHT CAPACITY LIMITS.



TRAILBLAZER STORAGE TRUNK

Made from easy to clean, high-impact resistant polyethylene. Equipped with rear brake light, key lock lid, and security reflectors on both sides. Center area allows more space for relaxing while stopped. Not for use as seat while riding. Large storage capacity. U-bolts used for mounting. Can be adapted to most types of ATVs. Measures 102 cm (40") L x 66 cm (26") W x 44,5 cm (17 1/2") H.

DESCRIPTION	PART #
TRAILBLAZER STORAGE TRUNK	3505-0120
REPLACEMENT LATCH KIT	3550-0223
REPLACEMENT LOCK KIT	3550-0224

NOTE: NEVER EXCEED MANUFACTURERS RECOMMENDED WEIGHT CAPACITY LIMITS.

OUTDOORSMAN STORAGE TRUNK

Made from easy to clean, high-impact resistant polyethylene. Large access door for storage. UV stabilized. Integrated rear brake light. Key lock lid. Top loops for strap locations. U-bolts used for mounting. Can be adapted to most types of ATVs. Measures 94,5 cm (37 1/4") L x 56 cm (22") W x 38,5 cm (15 1/4") H.

DESCRIPTION	PART #
OUTDOORSMAN STORAGE TRUNK	3505-0131
REPLACEMENT LATCH KIT	3550-0223
REPLACEMENT LOCK KIT	3550-0224

NOTE: NEVER EXCEED MANUFACTURERS RECOMMENDED WEIGHT CAPACITY LIMITS.



FRONT BASKET

Durable, vacuum formed basket at a lesser price than a rotational molded basket. Measures 86 cm (34") L x 42,5 cm (16 3/4") W x 11,5 cm (4 1/2") D. Made in the USA.

DESCRIPTION	PART #
FRONT BASKET	3505-0088
FRONT BASKET W/ COVER	3505-0089

NOTE: NEVER EXCEED MANUFACTURERS RECOMMENDED WEIGHT CAPACITY LIMITS.

REAR BASKET

Durable, vacuum formed basket at a lesser price than a rotational molded basket. Measures 112 cm (44") L x 57 cm (22 1/2") W x 15 cm (6") D. Made in the USA.

DESCRIPTION	PART #
REAR BASKET	3505-0096

NOTE: NEVER EXCEED MANUFACTURERS RECOMMENDED WEIGHT CAPACITY LIMITS.





PLOWS

WINCHES

UTV

RACKS

IMPLEMENTS
& TOWING

LUGGAGE

BODY

CONTROLS

ELECTRICAL

WHEELS
& TIRES

SUSPENSION
& DRIVE

BRAKING

ENGINE

RIDER

GARAGE

PROMO



A) SWINGARM SKIDPLATES

Heavy-duty aluminum skidplate protects your sprocket, swingarm and brake rotor from rocks and other debris. All mounting hardware included. Made in the USA.

B) FULL BODY SKIDPLATES

Heavy-duty aluminum skidplate protects the frame, engine case and undercarriage from rocks and debris. Includes oil drain hole. All mounting hardware included. Made in the USA.

C) A-ARM GUARDS

Constructed from 4,8 mm (3/16") aluminum alloy plate. Helps ATV slide over rocks without damaging the A-arms. All mounting hardware included. Made in the USA.

D) FLOORBOARD SKID PLATES

Left and right floor board skidplates. Constructed with 4,8 mm (3/16") 5052 H-32 aluminum. All mounting hardware included. Made in the USA.

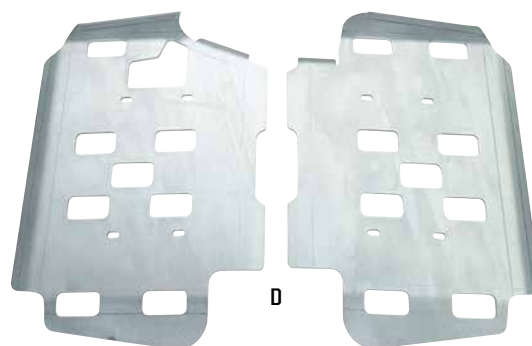

FITS MODEL	SWINGARM SKIDPLATE	FULL-BODY SKIDPLATE	A-ARM GUARDS	FLOORBOARD SKIDPLATE
SKIDPLATES				
ARCTIC CAT				
WILDCAT Trail 14-17	-	-	0505-1658	-
WILDCAT Sport 15-17	-	-	0505-1659	-
CAN AM				
DS450 08-12	0505-0933	-	-	-
450/500/570 OUTLANDER-L & L MAX 15-16	-	-	0430-0936	-
Outlander 500 Std. 13-18 (Gen 2 Frame)	-	0506-1083	-	-
Outlander 650 Std. 13-18 (Gen 2 Frame)	-	0506-1083	-	-
Outlander 800 STD 13-18 (Gen 2 Frame)	-	0506-1083	-	-
Outlander 1000 STD 13-18 (Gen 2 Frame)	-	0506-1083	-	-
COMMANDER 800/1000 MAX 11-18	-	-	0430-0785	-
MAVERICK 13-16	-	-	0505-1660	-
MAVERICK X-DS 15-16	-	-	0505-1661	-
MAVERICK X-XC 14-16	-	-	0505-1662	-
CF MOTO				
ZFORCE 800 16-17	-	0505-1665	0505-1663	-
HONDA				
TRX250R 86	M800-00	M900-10	-	-
TRX250R 87-89	M800-03	M900-10	-	-
TRX250X 93-09	M800-06	M900-15	-	-
TRX250EX 01-08	M800-09	M900-85	-	-
TRX250 RECON 97-18	M800-09	M900-85	-	-

FITS MODEL	SWINGARM SKIDPLATE	FULL-BODY SKIDPLATE	A-ARM GUARDS	FLOORBOARD SKIDPLATE
HONDA (CON'T)				
TRX300EX 93-09	M800-06	M900-15	-	-
Rancher 350/400 4X4 00-03	M800-72	M900-95	-	-
Rancher 350/400 04-07	M800-72	0505-0088	-	-
TRX400EX 99-15	0505-0097	M900-35	M700-04	-
TRX420 RANCHER 07-13 (SOLID-AXLE)	-	0505-0620	0430-0373	-
TRX420 RANCHER 14-18 (SOLID AXLE)	0505-1330	0506-0828	0430-0772	-
TRX420 RANCHER 09-14 (I.R.S.)	-	0506-0523	-	-
TRX420 RANCHER 15-18 (I.R.S.)	-	0506-0938	0430-0857	-
SKIDPLATES (CON'T)				
TRX450R 04-15	0505-0129	0505-0130	0430-0023	-
TRX500 FOREMAN 05-11	-	0506-0184	0430-0125	-
TRX500 FOREMAN 12-13	-	0506-0692	0430-0125	-
TRX500 FOREMAN 14-17	0505-1330	0506-0828	0430-0771	-
TRX500 RUBICON 05-14	-	0506-0185	0430-0125	-
TRX500 RUBICON 15-18 (AUTOMATIC)	-	0506-0938	0430-0857	-
TRX500 RUBICON 15-18 (MANUAL)	-	0506-0939	0430-0857	-
TRX650 RINCON 06-14	-	0505-0083	-	-
TRX650 RINCON 15-17	-	0505-0083	0430-0856	-
TRX680 RINCON 06-14	-	0505-0083	-	-
TRX680 RINCON 15-18	-	0505-0083	0430-0856	-
PIONEER 500 14-18	-	-	0430-0860	-
PIONEER 1000 / 1000-5 16-18	-	-	0430-0939	-
KAWASAKI				
BAYOU 220/250 90-06	-	M900-41	-	-
KFX400 03-06	M800-56	M900-64	M700-64	-
(REAR SHOCK LINKAGE COVER KXF400)	M800-84	-	-	-
KFX450R 08-15	0505-0625	0506-0360	-	-
BRUTE FORCE 650 I 07-09	-	-	0430-0092	0505-1558
BRUTE FORCE 650 I 10-17	-	0506-0383	0430-0092	0505-1558
BRUTE FORCE 750 05-07	-	-	0430-0092	0505-1558
BRUTE FORCE 750 08-18	-	0506-0383	0430-0092	0505-1558
TERYX 4 12-18	-	-	0430-0791	-
KYMCO				
UXV 700 14-16	-	-	0505-1664	-
KTM				
450/525 XC 08-12	-	0506-0515	-	-
POLARIS				
TRAILBLAZER 250 98-04	M800-36	-	M700-50	-
TRAILBLAZER 250 05-07	-	-	M700-50	-
EXPLORER 250 02-04	-	-	M700-50	-
TRAIL BOSS 325/330 00-04	M800-36	M800-89	M700-50	-
TRAIL BOSS 325/330 05-06	-	M800-89	M700-50	-
SCRAMBLER 400/500 2X4 & 4X4 98-04	M800-36	M800-89	M700-50	-
SCRAMBLER 400/500 2X4 & 4X4 05-07	-	M800-89	M700-50	-
SPORTSMAN 550 X2/TOURING 11-16	-	-	0430-0784	0505-1354
SPORTSMAN 550 X2/TOURING 17	-	-	0430-0784	-
SPORTSMAN 570 14	-	-	0430-0786	-
SPORTSMAN 570 15-17	-	-	0430-0786	-
SPORTSMAN 800 11-14	-	-	0430-0786	-
SPORTSMAN 850 X2/TOURING 11-16	-	-	0430-0784	0505-1354
SPORTSMAN 850 X2/TOURING 17	-	-	0430-0784	-
SPORTSMAN 1000 15-16	-	-	0430-0935	0505-1354
SPORTSMAN 1000 17	-	-	0430-0935	-
SCRAMBLER 850 13-17	-	0506-1084	0430-0784	0505-1354
SCRAMBLER 1000 13-17	-	0506-1084	0430-0784	0505-1354
RANGER 570 MID-SIZE 14-16	-	-	0430-0795	-
RANGER ETX 14-16	-	-	0430-0795	-
RANGER 570 FULL-SIZE 15-17	-	-	0430-0793	-
RANGER CREW 800 10-15	-	-	0430-0790	-
RANGER 800 09-15	-	-	0430-0790	-

FITS MODEL	SWINGARM SKIDPLATE	FULL-BODY SKIDPLATE	A-ARM GUARDS	FLOORBOARD SKIDPLATE
POLARIS (CON'T)				
RANGER 900XP 13-17	-	-	0430-0793	-
RANGER CREW 900 14-17	-	-	0430-0793	-
RANGER 1000XP 17-18	-	-	0430-0793	-
RANGER DIESEL 11-14	-	-	0430-0790	-
RANGER DIESEL 15-16	-	-	0430-0793	-
RZR-S 900 15-17	-	0505-1666	0430-0861	-
SKIDPLATES (CON'T)				
RZR-4 900 15-17	-	-	0430-0861	-
RZR XP TURBO EPS 16-18	-	0505-1667	-	-
RZR 1000 XP 16-18	-	0505-1667	-	-
RZR-S 1000 EPS 15-17	-	0505-1666	0430-0861	-
GENERAL 1000 16	-	-	0430-0861	-
GENERAL-4 1000 16-17	-	-	0430-0861	-
SUZUKI				
LT250R 85-86	M800-45	-	-	-
LTZ400 03-14	M800-56	M900-64	M700-64	-
LTZ400 (REAR SHOCK LINKAGE COVER)	M800-84	-	-	-
Eiger 400 02-07	-	0505-0085	M800-53	-
LT450R 06-09	0505-0425	0506-0268	-	-
KING QUAD 450 09-17	-	0506-0157	0430-0609	-
LT500R 87-90	M800-49	-	-	-
KING QUAD 500 09-17	-	0506-0157	0430-0609	-
Vinson 500 02-07	M800-55	-	M800-53	-
KING QUAD 700 09-17	-	0506-0157	0430-0609	-
KING QUAD 750 09-18	-	0506-0157	0430-0609	-
YAMAHA				
BLASTER 200 88-06	M800-54	M900-65	-	-
RAPTOR 250 08-15	0505-0932	0506-0516	-	-
WARRIOR 350 89-04	0505-0098	-	-	-
RAPTOR 350 05-15	0505-0279	-	-	-
GRIZZLY 350 05-08	-	-	M700-72	-
BANSHEE 350 87-06	0505-0099	M900-80	M700-13	-
BRUIN 350 03-15	-	-	M700-72	-
KODIAK 400/450 00-04	-	-	M700-72	-
YFZ450 04-05	-	0505-0094	0430-0009	-
YFZ450 06-15	0505-0426	0505-0094	0430-0009	-
YFZ450R 09-18 (ALUMINUM FRAME)	0505-1352	0505-1357	0430-0788	-
Wolverine 450 89-05	-	M900-70	-	-
WOLVERINE 450 06-10	-	-	M700-72	-
GRIZZLY 550 07-15	-	0506-0300	0430-0323	0505-1353
GRIZZLY 550 16-18	-	0506-0940	-	0505-1353
RAPTOR 660 01-05	M800-69	M900-90	-	-
GRIZZLY 660 02-08	-	-	M700-18	-
GRIZZLY 700 07-13	-	0506-0300	0430-0323	0505-1353
GRIZZLY 700 14-15	-	0506-0300	0430-0778	0505-1353
GRIZZLY 700 16-18	-	0506-0940	0430-0858	0505-1353
Kodiak 700 16-18	-	0506-0940	0430-0859	0505-1353
RAPTOR 700 06-15	0505-0394	0506-0242	0430-0009	-
Rhino (all models) 04-13	-	-	0430-0095	-
VIKING 14-17	-	-	0430-0794	-
WOLVERINE & R-SPEC 15-18	-	-	0430-0938	-
YXZ1000 16-17	-	0506-1085	0430-0937	0505-1559



REAR TRAILING ARM GUARDS FOR POLARIS RZR

Left and right rear linkage guards. Constructed with 4,8 mm (3/16") 5052 H-32 aluminum. All mounting hardware included. Made in the USA.

FITS MODEL	PART #
POLARIS	
RZR 900 XP 12-14	0505-1636
RZR-4 900 XP 12-14	0505-1636
RZR 1000 HIGH-LIFTER & DESERT 16-17	0505-1637
RZR 1000 HIGH-LIFTER & DESERT 15	0505-1637
RZR XP-4 1000 HIGH-LIFTER 16-18	0505-1637
RZR XP-4 TURBO EPS 16-18	0505-1637
RZR XP TURBO EPS 16-18	0505-1637
RZR XP-4 1000 14-15	0505-1637
RZR 1000 XP 13-18	0505-1637



ATV/UTV CV PROTECTORS

Provides added protection for your CV boots. Easy to install. Comes with zip ties for a secure fit. One size fits most UTVs and ATVs. Available in black only. Sold in pairs. Made in the USA.

DESCRIPTION	PART #
ATV/UTV CV PROTECTORS	0214-0969



LICENSE PLATE HOLDER

102 mm (4") x 203 mm (8") plate designed for decal placement. Made in the USA.

DESCRIPTION	PART #
LICENSE PLATE HOLDER	2030-1222

PLOWES

WINCHES

UTV

RACKS

IMPLEMENTS
& TOWING

LUGGAGE

BODY

CONTROLS

ELECTRICAL

WHEELS
& TIRES

SUSPENSION
& DRIVE

BRAKING

ENGINE

RIDER

GARAGE

PROMO

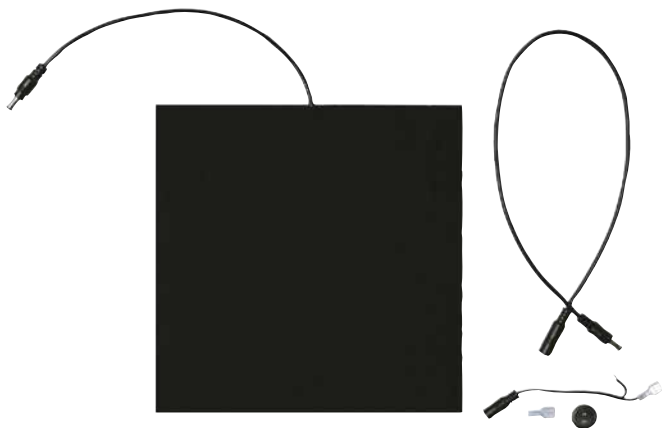

SEAT HEATER

Works with ATVs, UTVs, motorcycles and snowmobiles. Ultra thin, flexible and easy to install under the stock seat cover. Measures 229 mm (9") x 229 mm (9"). Durable long-lasting carbon fiber cloth-like element. 30 watts (less than 2 amps). Includes a 61 cm (24") quick-disconnect cable for easy seat removal, on/off switch and required hardware for installation. Made in the USA.

DESCRIPTION	PART #
SEAT HEATER	0821-1612



LICENSE DECAL KIT

Included white background measures; 102 mm (4") L x 191 mm (7 ½") H. Kits include two sets of black number decals, one set of black letter decals. Before ordering, please check the statutory requirements regarding vehicle registration and license plates of the state in which you want to use your vehicle/license plate. In many states, DIY license plates are illegal.

DESCRIPTION	PART #
LICENSE DECAL KIT	4303-0166

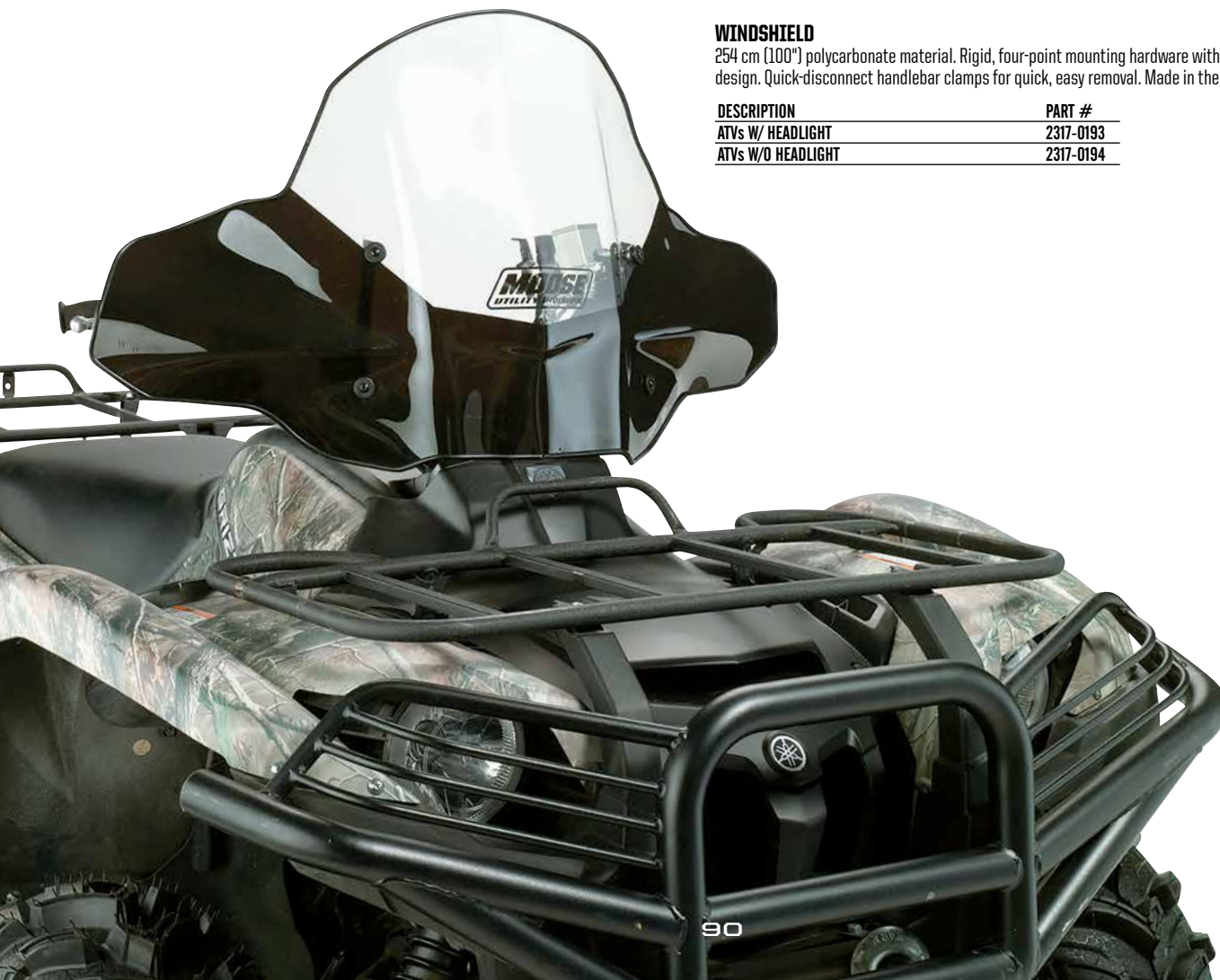

WINDSHIELD

254 cm (100") polycarbonate material. Rigid, four-point mounting hardware with breakaway design. Quick-disconnect handlebar clamps for quick, easy removal. Made in the USA.

DESCRIPTION	PART #
ATVs W/ HEADLIGHT	2317-0193
ATVs W/O HEADLIGHT	2317-0194



SEAT FOAM

Replace that torn up seat! OEM-style seat foam at a fraction of the cost. Uses stock base plate. Made in the USA.

FITS MODEL	PART #
SEAT FOAM	
ARCTIC CAT	
400 06-10	0812-0044
450 11-12	0812-0044
500 05-08	0812-0044
550 09-14	0812-0044
650 05-10	0812-0044
700 06-14	0812-0044
1000 08-17	0812-0044

FITS MODEL	PART #
SEAT FOAM (CON'T)	
CAN-AM	
OUTLANDER 500/650 07-12	0812-0043
OUTLANDER 800 06-11	0812-0043
HONDA	
TRX300 FW 88-00	0812-0018
TRX350/400 RANCHER 00-03	0812-0019
TRX350/400 RANCHER 04-07	0812-0047
TRX420 RANCHER 07-13	0812-0048
TRX450 FW FOREMAN 98-04	0812-0020
TRX500 FW RUBICON 01-04	0812-0049
TRX500 FW RUBICON 05-14	0812-0046
TRX500 FOREMAN 05-11	0812-0046
POLARIS	
325 MAGNUM 00-02	0812-0022
330 MAGNUM 03-06	0812-0022
330 TRAILBOSS 02-09	0812-0022
335 SPORTSMAN 99-00	0812-0022
400 SPORTSMAN 01-04	0812-0022
400 SPORTSMAN 05	0812-0045
400 SPORTSMAN 11-14	0812-0045
450 SPORTSMAN 06-07	0812-0045
500 MAGNUM 99-02	0812-0022
500 SPORTSMAN 96-04	0812-0022

FITS MODEL	PART #
SEAT FOAM (CON'T)	
POLARIS (CON'T)	
500 SPORTSMAN 05-13	0812-0045
600 SPORTSMAN 03-04	0812-0022
600 SPORTSMAN 05	0812-0045
700 SPORTSMAN 02-04	0812-0022
700 SPORTSMAN 05-07	0812-0045
800 SPORTSMAN 05-14	0812-0045
YAMAHA	
YFM250 BIG BEAR 07-09	0812-0023
YFM250 BRUIN 05-06	0812-0023
YFM350 BRUIN 04-06	0812-0023
YFM350 GRIZZLY 07-11	0812-0023
YFM400 KODIAK 00-06	0812-0023
YFM450 KODIAK 00-06	0812-0023
YFM550 GRIZZLY 09-14	0812-0042
YFM660 GRIZZLY 02-08	0812-0021
YFM700 GRIZZLY 07-15	0812-0042

BODY



CORDURA SEAT COVERS

Fits over the existing seat cover. No stapling necessary; elastic shock cord sewn into the bottom that holds the cover in place. Weather-resistant and can be machine washed. Made in the USA.

FITS MODEL	BLACK PART #
CORDURA SEAT COVERS	
ARCTIC CAT	
99-01 ALL 4X4 MODELS ONLY	MUD101
02-04 ALL 4X4 MODELS ONLY (NO TBX MODELS)	0821-0194
HONDA	
TRX250 RECON 97-04	MUD120
TRX250 RECON 05-14	0821-0331
TRX300 4X4 88-95	MUD102
TRX300 2X4/4X4 96-00	MUD102
TRX350 RANCHER 2X4/4X4 00-03	MUD112
TRX350/400 RANCHER 4X4/2X4 04-07	0821-0195
TRX420 RANCHER 07-14 (IRS)	0821-0717
TRX420 RANCHER 14-15 (STRAIGHT AXLE)	0821-1782
TRX400 4X4 FOREMAN 98-04	MUD103
TRX450S/ES 4X4 FOREMAN 98-04	MUD103
TRX500 FOREMAN 05-11	0821-0329
TRX500 FOREMAN 12-15	0821-1780
TRX500 RUBICON 00-04	MUD113
TRX500 RUBICON 05-12	0821-0333
TRX650 RINCON 03-05	MUD121
TRX680 RINCON 06-15	MUD121
KAWASAKI	
KVF300/400 PRAIRIE 97-01	MUD104
BRUTE FORCE 750 & 650I 05-15	0821-0335



FITS MODEL

CORDURA SEAT COVERS (CON'T)

FITS MODEL	BLACK PART #
POLARIS	
250 TRAIL BOSS 96-99	-
300 XPLORER 98-02	MUD105
300 XPRESS 98-02	MUD105
325 MAGNUM 00-02	MUD105
325 TRAIL BOSS 00-01	-
325 XPEDITION 01-02	MUD105
335 SPORTSMAN 98-03	MUD105
400 SPORTSMAN 96	-
400 SPORTSMAN 04	-
400 XPLORER 99-02	MUD105
425 XPEDITION 00-02	MUD105
425 2X4/4X4 MAGNUM 96-98	MUD105
500 SPORTSMAN 98-03	MUD105
500 SPORTSMAN HO 04	-
500 MAGNUM 99-02	MUD105
600 SPORTSMAN TWIN 04	-
700 SPORTSMAN 02-03	MUD105
700 SPORTSMAN TWIN EFI 04	-
DIESEL	MUD105
400/500/600/700/800 SPORTSMAN 05-10	0821-0337

SUZUKI

LT-300 KING QUAD 99-03	MUD108
KING QUAD 450 & 500 07-15	-
LT-F500 97-02	MUD106
LT-A500F QUADMASTER 00-02	MUD106
LT-A500F VINSON 500 02-06	MUD116
KING QUAD 700 05-08	-
KING QUAD 750 09-15	-

YAMAHA

YFM350 BIG BEAR 94-99	MUD109
YFM350 BRUIN 04-06	0821-0345
YFM350 GRIZZLY 07-11	0821-0345
YFM400 BIG BEAR 00-11	-
YFM400 KODIAK 00-04	MUD114
YFM450 KODIAK 03-04	MUD114
YFM600 GRIZZLY 98-01	MUD107
YFM660 GRIZZLY 02-07	MUD117
YFM550 & YFM700 GRIZZLY 07-15	00821-0719

NEOPRENE SEAT COVERS

3 mm black neoprene insert provides comfort and a waterproof barrier between the rider and the seat. Conforms to the seat for a tight custom fit that protects the seat from damage. Heavy elastic around edge of seat cover makes for easy installation with no tools. Made in the USA.

FITS MODEL	BLACK PART #
HONDA	
TRX300 4X4/2X4 88-00	0821-0691
TRX350 RANCHER 00-03	0821-0696
TRX350/400 RANCHER 04-06	0821-0703
TRX400 FOREMAN 98-04	0821-0692
TRX420 RANCHER (IRS) 07-14	0821-0723
TRX450S/ES FOREMAN 98-04	0821-0692
TRX500 FOREMAN 05-13	-
TRX500 RUBICON 05-13	0821-0706
YAMAHA	
KODIAK 00-04	0821-0698
YFM450 KODIAK 03-04	0821-0698



OEM REPLACEMENT SEAT COVERS

Heavy-duty, UV resistant, black marine grade vinyl. Double stitched for durability. Must remove stock seat cover to staple on new cover. Made in the USA.

FITS MODEL	BLACK PART #	HIDDEN CREEK AUTUMN CAMO PART #
OEM REPLACEMENT SEAT COVERS		
ARCTIC CAT		
400 06-10	0821-1183	0821-2618
450 11-12	0821-1183	0821-2618
500 05-08	0821-1183	0821-2618
550 09-14	0821-1183	0821-2618
650 05-10	0821-1183	0821-2618
700 06-14	0821-1183	0821-2618
1000 08-17	0821-1183	0821-2618
CAN-AM		
OUTLANDER 500 07-12	0821-1406	0821-2616
RENEGADE 500 08-15	0821-1412	-
OUTLANDER 650 07-12	0821-1406	0821-2616
OUTLANDER 800 06-12	0821-1406	0821-2616
OUTLANDER 800/1000 12-17, 500/650 13-17	0821-2360	0821-2617
HONDA		
TRX200 91-97	0821-1414	-
TRX250 RECON 97-04	0821-1186	-
TRX250 RECON 05-19	0821-1004	-
TRX300 FW 88-00	0821-1008	0821-2625
TRX350/400 RANCHER 00-03	0821-1009	0821-2626
TRX350/400 RANCHER 04-07	0821-1010	0821-2627
TRX400 FW FOREMAN 95-01	0821-1011	-
TRX420 RANCHER 07-13	0821-1013	0821-2628
TRX420 RANCHER 14-19	0821-1517	0821-2630
TRX450 FW FOREMAN 98-04	0821-1014	0821-2629
TRX500 FOREMAN 05-11	0821-1016	0821-2631
TRX500 FOREMAN 14-19	0821-1517	0821-2630
TRX500 FW RUBICON 01-04	0821-1015	-
TRX500 FW RUBICON 05-14	0821-1016	0821-2631
TRX650 RINCON 03-06	0821-1017	-
TRX680 RINCON 06-19	0821-1017	-
TRX 500 RUBICON 15-19	0821-2361	0821-2632
KAWASAKI		
KLF220 BAYOU 88-01	0821-1184	-
KLF250 BAYOU 02-11	0821-1184	-
KLF300 BAYOU 4X4 86-88	0821-1408	-
KLF300 BAYOU 4X4 89-04	0821-1178	-
KLF300 BAYOU 2X4 89-04	0821-1408	-
KVF300 PRAIRIE 99-02	0821-1127	-
KVF360 PRAIRIE 02-14	0821-1416	-
KLF400 BAYOU 93-99	0821-1178	-
KVF400 PRAIRIE 97-02	0821-1127	-
KVF650I BRUTE FORCE 05-17	0821-0998	0821-2619
KVF650 BRUTE FORCE 06-11	0821-0997	-
KVF650 PRAIRIE 02-03	0821-0997	-
KVF700 PRAIRIE 04-06	0821-0997	-
KVF750 BRUTE FORCE 05-19	0821-0998	0821-2619
POLARIS		
325 MAGNUM 00-02	0821-1001	0821-2621
325 TRAIL BOSS 94-97	0821-1409	-
330 MAGNUM 03-06	0821-1001	0821-2621
330 TRAIL BOSS 02-09	0821-1001	0821-2621
335 SPORTSMAN 99-00	0821-1001	0821-2621
400 SPORTSMAN 94-97	0821-1409	-
400 SPORTSMAN 01-04	0821-1001	0821-2621

FITS MODEL	BLACK PART #	HIDDEN CREEK AUTUMN CAMO PART #
OEM REPLACEMENT SEAT COVERS (CON'T)		
POLARIS (CON'T)		
400 SPORTSMAN 05	0821-1002	0821-2622
400 SPORTSMAN 11-14	0821-1002	0821-2622
450 SPORTSMAN 06-07	0821-1002	0821-2622
500 MAGNUM 99-02	0821-1001	0821-2621
500 SPORTSMAN 96-04	0821-1001	0821-2621
500 SPORTSMAN 05-14	0821-1002	0821-2622
550 SPORTSMAN XP 09-17	0821-1513	0821-2623
600 SPORTSMAN 03-04	0821-1001	0821-2621
600 SPORTSMAN 05	0821-1002	0821-2622
700 SPORTSMAN 02-04	0821-1001	0821-2621
700 SPORTSMAN 05-07	0821-1002	0821-2622
800 SPORTSMAN 05-14	0821-1002	0821-2622
850 SPORTSMAN XP 09-17	0821-1513	0821-2623
570 SPORTSMAN 14-17	0821-2362	0821-2624
450/570 SPORTSMAN 18-19	0821-3005	-
550/1000 SPORTSMAN 17-19	0821-3006	-
850/1000 SPORTSMAN HIGH LIFTER 18-19	0821-3008	-
SUZUKI		
LTF160 89-01	0821-1417	-
LTF250 OZARK 02-14	0821-1179	-
LTF250 QUAD RUNNER 87-89	0821-1128	-
LTF250 QUAD RUNNER 99-02	0821-1129	-
LTF300 KING QUAD 91-98	0821-1128	-
LTF300 KING QUAD 99-02	0821-1129	-
LTF400 EIGER 02-07	0821-1000	-
LTA400 KING QUAD 08-19	0821-1514	-
LTA450 KING QUAD 07-09	0821-0999	0821-2620
LTA500 KING QUAD 09-19	0821-0999	0821-2620
LTF500 QUADRUNNER 98-02	0821-1180	-
VINSON 500 02-07	0821-1185	-
LTA700 KING QUAD 05-07	0821-0999	0821-2620
LTA750 KING QUAD 08-19	0821-0999	0821-2620
YAMAHA		
YFM250 BEAR TRACKER 99-04	0821-1418	-
YFB250 TIMBERWOLF 92-01	0821-1019	-
YFM250 BIG BEAR 07-09	0821-1020	0821-2633
YFM250 BRUIN 05-06	0821-1020	0821-2633
YFM350 BRUIN 04-06	0821-1020	0821-2633
YFM350 GRIZZLY 07-14	0821-1020	0821-2633
YFM350 BIG BEAR 87-99	0821-1130	-
YFM400 BIG BEAR 00-06	0821-1023	-
YFM400 GRIZZLY 07-08	0821-1020	0821-2633
YFM400 KODIAK 93-95	0821-1420	-
YFM400 KODIAK 96-99	0821-1410	-
YFM400 KODIAK 00-06	0821-1020	0821-2633
YFM450 GRIZZLY 07-14	0821-1020	0821-2633
YFM450 KODIAK 00-06	0821-1020	0821-2633
YFM450 KODIAK 19	0821-3009	-
YFM550 GRIZZLY 09-14	0821-1025	0821-2634
YFM660 GRIZZLY 02-08	0821-1026	0821-2635
YFM600 GRIZZLY 97-01	0821-1131	-
YFM700 GRIZZLY 07-15	0821-1025	0821-2634
YFM700 GRIZZLY 16-19	0821-2363	0821-2636
YFM700 KODIAK 16-19	0821-2364	0821-2637

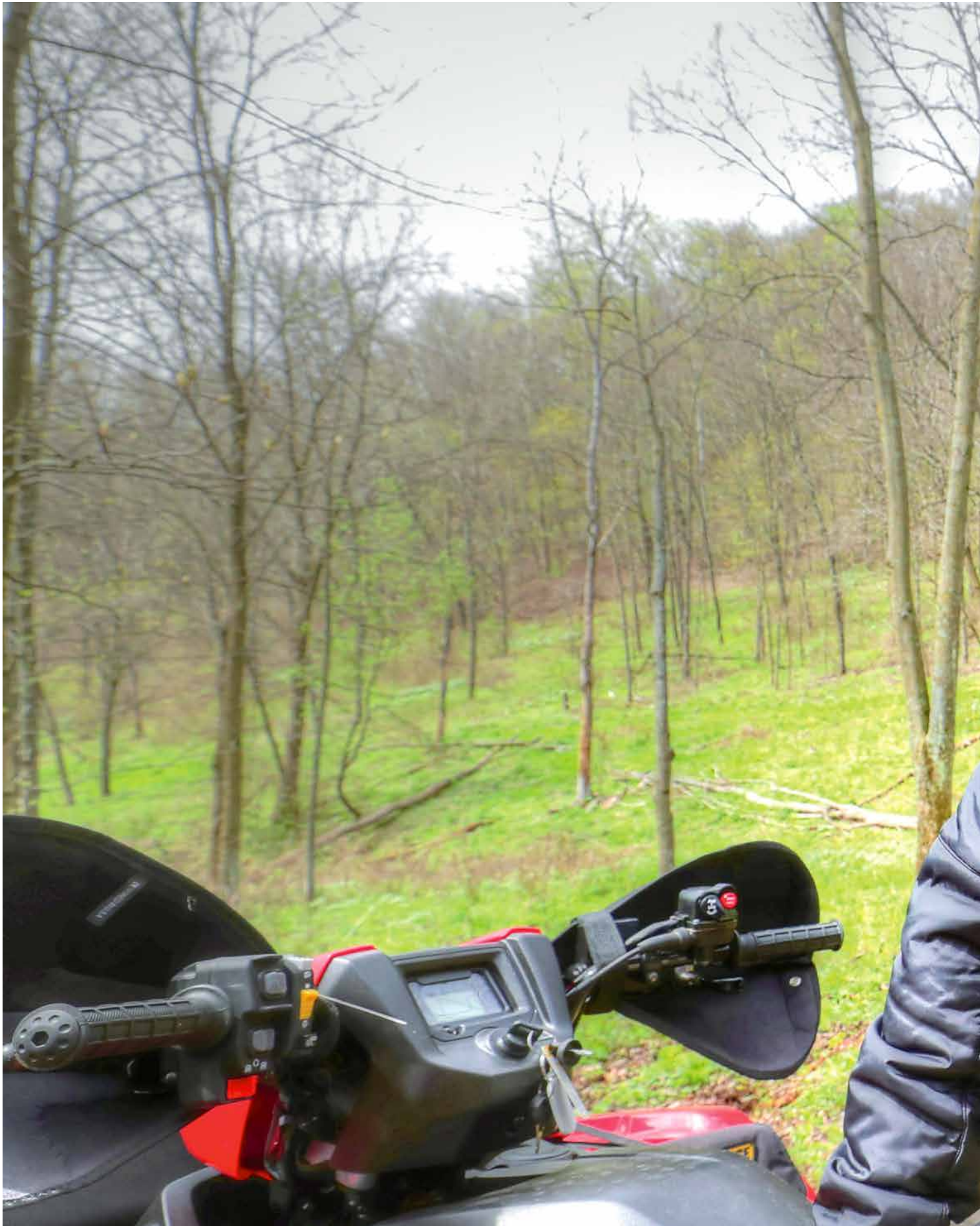

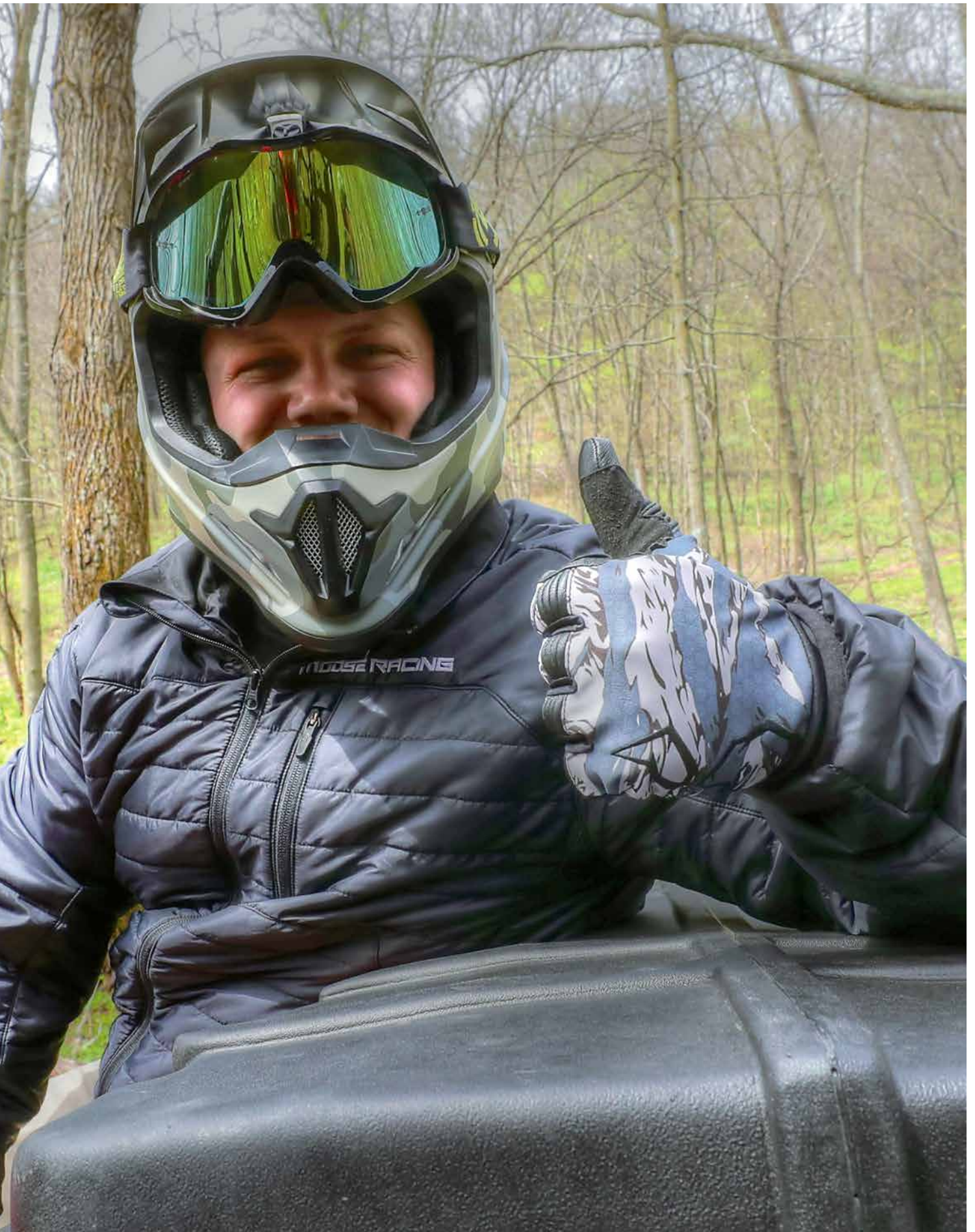

PLOWS

WINCHES

UTV

RACKS

IMPLEMENTS
& TOWING

LUGGAGE

BODY

CONTROLS

ELECTRICAL

WHEELS
& TIRES

SUSPENSION
& DRIVE

BRAKING

ENGINE

RIDER

GARAGE

PROMO

CONTROLS



HANDGUARDS

Available for all of your favorite models. Contoured for a custom look. Mount to handlebars. Sold in pairs. Made in the USA.

FITS MODEL	COLOR	PART #
HONDA		
TRX400AT RANCHER 04-08	BLACK	0635-0074
TRX420AT RANCHER 13	RED	0635-0075
TRX500 RUBICON 01-14	STEALTH BLACK	0635-0930
TRX650 RINCON 03-05		
TRX680 RINCON 06-17		
TRX500 FOREMAN 04-11	BLACK	0635-0195
TRX420 EFI RANCHER 07-13	RED	0635-0196
TRX420 AT RANCHER 09-12	OLIVE	0635-0197
	STEALTH BLACK	0635-0931
TRX500ES/FM FOREMAN 4X4 12-16	BLACK	0635-0895
TRX420 EFI RANCHER 14-17	RED	0635-0896
TRX500 RUBICON 15-16	STEALTH BLACK	0635-0932
KAWASAKI		
KVF360 PRAIRIE 4X4 03-13	BLACK	0635-0045
KVF650 BRUTE FORCE 4X4/1 05-13	STEALTH BLACK	0635-0933
KVF750 BRUTE FORCE 05-17		
POLARIS		
ALL 01-04 (WITH PLASTIC THROTTLE) (MODELS WITH BLACK MASTER CYLINDER HAVING LEVEL WINDOW IN TOP CAP) (NO 6X6, PREDATOR, 50CC OR 90CC)	BLACK	MHG504BK
SUZUKI		
LTF250 OZARK 03-06	BLACK	MHG478BK
LT400 EIGER 02-07	STEALTH BLACK	0635-0934
LT400 KING QUAD 08-11		
LT450 KING QUAD 07-10		
LT500 VINSON 02-07		
LT500 KING QUAD 09-16		
LT700 KING QUAD 05-07		
LT700 TWIN PEAKS 04-05		
LT750 KING QUAD 08-18		
YAMAHA		
YFM250 BRUIN 05-06	BLACK	MHG506BK
YFM250 BEARTRACKER 03-04	RED	MHG506R
YFM350 BRUIN 2X4/4X4 04-06	STEALTH BLACK	0635-0935
YFM350 GRIZZLY 07-14		
YFM350 BIG BEAR 2X4 96-99		
YFM350 BIG BEAR 4X4 87-99		
YFM400 KODIAK 93-99		
YFM400 KODIAK 2X4 03-04		
YFM400 GRIZZLY 07-10		
YFM400 BIG BEAR 2X4 03-05		
YFM400 BIG BEAR 4X4 02-12		
YFM400 KODIAK 4X4 02-06		
YFM450 GRIZZLY 07-14		
YFM600 GRIZZLY 98-01		
YFM660 GRIZZLY 02-08		
YFM550 GRIZZLY 09-14	BLACK	0635-0544
YFM700 GRIZZLY 07-17	STEALTH BLACK	0635-0936



OEM REPLACEMENT HANDLEBARS

Avoid paying OEM cost for replacement handlebars. Available in OEM bends. 22,2 mm (7/8") diameter and made from 0.083 steel tubing. Made in the USA.

FITS MODEL	PART #
CAN-AM	
OUTLANDER 500/650/800/1000 06-13	0601-4379
HONDA	
TRX300 88-93	0601-4376
TRX400 FOREMAN 95-98	0601-4376
TRX500 RUBICON 01-03	0601-4376
TRX650/680 RINCON 03-18	0601-4376
POLARIS	
SPORTSMAN (ALL) 96-10	0601-4375
SUZUKI	
ALL KING QUAD MODELS 05-13	0601-4377
YAMAHA	
GRIZZLY 550/700 08-14	0601-4378



FOAM HANDGUARDS

Outer shell is made from heavy-duty 500 denier nylon with 13 mm (1/2") closed cell foam to keep cold, wind and debris at bay. Cinch strap type mounting provides a universal fit for nearly any model of ATV. Twin gromets on the outside of each guard enable the rider to attach cable ties for a more rigid mount.

DESCRIPTION	PART #
FOAM HANDGUARDS	0635-0760



PAWS GAUNTLETS

Heavy Cordura® outer shell with fleece lining helps keep your hands warm. Designed to allow more room for controls and installs easily. Hook and loop type fastener that seals around the handlebars.

DESCRIPTION	PART #
BLACK	0635-0917



CLEARVIEW ATV MIRROR W/ VIBRATION ISOLATOR

Rectangular shaped, convex style mirror shows less vibration, and a wider field-of-view. The mirror is locked into the housing by a vibration reducing rubberized seal. Spring tension ball joint allows 360° of rotation and 15° of tilt.

DESCRIPTION	PART #
CLEARVIEW ATV MIRROR W/ VIBRATION ISOLATOR	0640-1315

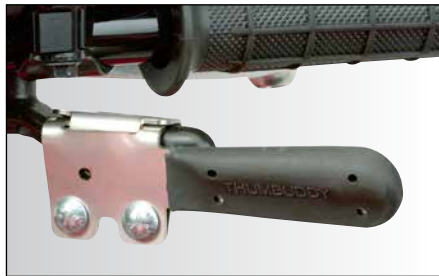

THUMB ASSIST

Bolt-on thumb throttle extender attaches to all models of ATVs. The extender helps to relieve hand fatigue and can adjust to fit various hand sizes for a more comfortable ride. Made from stainless steel with a soft rubber coating. **WARNING: DO NOT USE WITH HANDLEBAR MITTS OR GUARDS. EXTENDER CAN BECOME CAUGHT UNDER MITT CAUSING UNINTENDED ACCELERATION.**

DESCRIPTION	PART #
THUMB ASSIST	0632-0459



FOAM GRIPS

Soft closed cell foam grips. Fits 22,2 mm (7/8") bars with thumb throttles. 127 mm (5") long; end caps included. Sold in pairs. Made in the USA.

DESCRIPTION	PART #
FOAM GRIPS	0630-0699



LOCK-ON GRIP SYSTEM

No more using glue, paint thinner, or safety wire to keep your grips from twisting or slipping. Lock-on grips provide slip-free performance right out of the box. Revolutionary system survives the most severe weather. Installation and removal is easy and will not destroy your grips. Grips slide effortlessly on and off your bars and are locked into place with a few turns of a wrench. Includes removable end plugs for added protection against "grip blowout." Compatible with the ODI lock-on grip system. Grip length is 120 mm. Sold in pairs. Made in the USA.

DESCRIPTION	PART #
LOCK-ON GRIP SYSTEM	0630-0979



STEALTH GRIPS

Custom half-waffle pattern with high-traction chevrons. Wire grooves don't interfere with grip comfort. Special made compound feels soft, but wears like a harder compound. Comes with 22,2 mm (7/8") inner diameter and small flanges for thumb throttles. Sold in pairs. Made in the USA.

DESCRIPTION	PART #
BLACK	0630-0395
GRAY	0630-0396
RED	0630-0397
BLUE	0630-0398
ORANGE	0630-0423



STEEL FOLDING SHIFT LEVERS

Folding tips prevent snagging and withstand repeated bends, no breaking. Hardened splines. Made in the USA.

FITS MODEL	PART #
HONDA	
TRX250X 87-92	1602-1243
TRX250 RECON 97-14	1602-1239
TRX250R 86-89	1602-1244
TRX300EX 88-01	1602-1243
TRX300 2X4/4X4 88-99	1602-1241
TRX350 RANCHER 01-03	1602-1242
TRX400EX 99-09,12-14	1602-1240
TRX400 FOREMAN 95-04	1602-1239
TRX450S FOREMAN 98-04	1602-1239



HAND SHIFTERS

Great on all models. Universal models mount to most ATV foot shift levers. Sturdy construction with strong mountings. Made in the USA.

DESCRIPTION	PART #
UNIVERSAL, 38 CM (15") HANDLE	MUD4632
UNIVERSAL, 56 CM (22") HANDLE	MUD4620
YAMAHA YFM350 BIG BEAR 87-09, 51 CM (20") HANDLE	MUD4054
SUZUKI LT400 EIGER, LT250 KING QUAD, LT-F500 QUADRUNNER, 51 CM (20") HANDLE	MUD4698





ATV CLAMP-ON QUAD ZONE HEATED GRIPS

Two clamp-on heated grips. One adhesive-backed silicone thumbwarmer. Quad zone controller - select thumb and grip heat levels separately with additional zones for heated seat, vest or insoles. 5 level power memory. Grips-maximum 40 watts (20 watts per grip) at 14-volts. Thumbwarmer - maximum 5 watts at 14 volts. Made in the USA.

DESCRIPTION	PART #
ATV CLAMP ON QUAD ZONE HEATED GRIPS	0631-0155
REPLACEMENT GRIP	0631-0160
REPLACEMENT CONTROLLER	0631-0166



THUMB WARMER KIT

Keeps thumb warm in cold weather. Simple operation high/low/off switch. Installation is easy, just peel and press. Made in the USA.

DESCRIPTION	PART #
THUMB WARMER KIT	0631-0114
REPLACEMENT THUMB WARMER	0631-0164



ATV CLAMP-ON DUAL ZONE HEATED GRIPS

Two clamp-on heated grips. One adhesive-backed silicone thumb warmer. Dual zone controller - select thumb and grip heat levels separately. 5 level power memory. Grips - maximum 40 watts (20 watts per grip) at 14-volts. Thumb warmer - maximum 5 watts at 14-volts. Made in the USA.

DESCRIPTION	PART #
ATV CLAMP ON DUAL ZONE HEATED GRIPS	0631-0154
REPLACEMENT GRIP	0631-0160
REPLACEMENT CONTROLLER	0631-0165



HAND WARMER KIT

Effective at keeping hands warm. Simple operation high/low/off switch. Made in the USA.

DESCRIPTION	PART #
HAND WARMER KIT	M92-21007
REPLACEMENT HIGH/LOW/OFF SWITCH-METAL	M92-22004
REPLACEMENT ELEMENT	M92-21014



ATV CLAMP-ON HIGH/LOW HEATED GRIPS

Two clamp-on heated grips. High/low round rocker switch. Made in the USA.

DESCRIPTION	PART #
ATV CLAMP ON HIGH/LOW HEATED GRIPS	0631-0187
REPLACEMENT GRIP LEFT/RIGHT	0631-0162
REPLACEMENT SWITCH	0631-0009



DRINK CUP HOLDER

Securely attaches to your ATV's rack or handlebars. Self-levels to ensure your drink won't spill. Contents not included.

DESCRIPTION	PART #
DRINK CUP HOLDER	3550-0031



CONTROL CABLES

Black PVC outer jacket for maximum flexibility & durability. Steel inner casing that is tightly coiled for low compression ratios. Pre-lubricated nylon inner sleeve guarantees smooth operation and long life. All wire ends are bird caged prior to terminal casting for superior pull-out resistance. EPDM molded rubber components for high UV resistance & long life. Injected molded components are manufactured from high strength POM material.

FITS MODEL	THROTTLE PART #	CLUTCH PART #	REAR BRAKE PART #	REAR HAND PARK BRAKE PART #
CONTROL CABLES				
ARCTIC CAT				
250 2X4 02-05	0650-1372	-	0653-0097	-
250 4X4 02-05	0650-1372	-	0653-0097	-
250 2X4/4X4 02-05	0650-1372	-	-	-
250 2X4 99-01	-	-	0653-0097	-
250 4X4 01	-	-	0653-0097	-
300 2X4 02-04	0650-1372	-	0653-0097	-
300 2X4 98-01	-	-	0653-0097	-
300 4X4 02-05	0650-1372	-	0653-0097	-
300 4X4 98-01	-	-	0653-0097	-
366 FIS W/AT 09-11	0650-1331	-	-	-
375 2X4/4X4 W/AT 02	0650-1331	-	-	-
400 4X4 W/AT 03-04	0650-1331	-	-	-
400 4X4 W/MT 02-04	0650-1331	-	-	-
400 DVX 04-08	0650-1314	0652-1785	-	-
400 FIS 2X4 W/AT&MT 03-04	0650-1331	-	-	-
400 FIS 4X4 TRV 09-14	0650-1331	-	-	-
400 FIS 4X4 W/AT 03-08	0650-1331	-	-	-
400 FIS 4X4 W/MT 02-07	0650-1331	-	-	-
400 FIS 4X4 W/MT 08	0650-1330	-	-	-
400 TBX 4X4 04-06	0650-1331	-	-	-
400 VP 4X4 W/AT&MT 06	0650-1331	-	-	-
450 TRV 12	0650-1331	-	-	-
500 4X4 W/AT 00-02	0650-1331	-	-	-
500 4X4 W/MT 01	0650-1331	-	-	-
500 FIS 4X4 W/AT&MT 02-09	0650-1331	-	-	-
500 FIS TBX 4X4 02-06	0650-1331	-	-	-
500 FIS TRV 4X4 03-08	0650-1331	-	-	-
650 4X4 HI 05-11	0650-1331	-	-	-
650 4X4 HI MUD PRO 10-11	0650-1331	-	-	-
650I 4X4 12	0650-1331	-	-	-
1000I LTD EFI MUD PRO 12-14	0650-1359	-	-	-
H2 MUDPRO 10	0650-1359	-	-	-
CAN-AM				
DS 90 4-STROKE 06-07	0650-1324	-	-	-
DS 90 4-STROKE 08	0650-1325	-	-	-
OUTLANDER 400 STD 4X4 09-15	0650-1326	-	-	-
OUTLANDER 400 XT 4X4 12-14	0650-1326	-	-	-
OUTLANDER MAX 400 EFI/STD/XT 15	0650-1326	-	-	-
OUTLANDER MAX 400 STD 4X4 09-14	0650-1326	-	-	-
OUTLANDER MAX 400 XT 4X4 13-14	0650-1326	-	-	-
DS 450 10-15	-	0652-1796	-	-
DS 450 EFI MXC 10-12	-	0652-1796	-	-
DS 450 EFI XXC 09-12	-	0652-1796	-	-
DS 450 STD/X 08-09	-	0652-1796	-	-
DS 450 XXC XMX 15	-	0652-1796	-	-
OUTLANDER L 450 EFI 15-17	0650-1330	-	-	-
OUTLANDER L MAX 450 EFI 15-17	0650-1330	-	-	-
OUTLANDER 500 EFI 15	0650-1330	-	-	-
OUTLANDER 500 STD 4X4 12	0650-1329	-	-	-
OUTLANDER 500 STD 4X4 13-14	0650-1330	-	-	-
OUTLANDER 500 XT 4X4 12	0650-1326	-	-	-
OUTLANDER 500 XT 4X4 13-14	0650-1330	-	-	-
OUTLANDER L 500 EFI 15	0650-1330	-	-	-
OUTLANDER L MAX 500 EFI 15	0650-1330	-	-	-
OUTLANDER MAX 500 EFI 15	0650-1330	-	-	-
OUTLANDER MAX 500 STD 4X4 12	0650-1329	-	-	-
OUTLANDER MAX 500 STD 4X4 13-14	0650-1330	-	-	-
OUTLANDER MAX 500 XT 4X4 12	0650-1326	-	-	-
OUTLANDER MAX 500 XT 4X4 13-14	0650-1330	-	-	-
RENEGADE 500 12	0650-1329	-	-	-
RENEGADE 500 13-15	0650-1330	-	-	-
OUTLANDER L 570 EFI 16	0650-1330	-	-	-
OUTLANDER LE 570 EFI 16	0650-1330	-	-	-
OUTLANDER MAX 570 EFI 16	0650-1330	-	-	-
OUTLANDER MAX DPS 570 EFI 16	0650-1330	-	-	-

FITS MODEL	THROTTLE PART #	CLUTCH PART #	REAR BRAKE PART #	REAR HAND PARK BRAKE PART #
CONTROL CABLES (CONT)				
CAN-AM (CONT)				
OUTLANDER X MR 570 EFI 16-17	0650-1330	-	-	-
RENEGADE 570 EFI 16-17	0650-1330	-	-	-
OUTLANDER 650 6X6 15	0650-1330	-	-	-
OUTLANDER 650 STD 4X4 12	0650-1329	-	-	-
OUTLANDER 650 STD 4X4 13-15	0650-1330	-	-	-
OUTLANDER 650 XMR 13-15	0650-1330	-	-	-
OUTLANDER 650 XT 4X4 12	0650-1329	-	-	-
OUTLANDER 650 XT 4X4 13-14	0650-1330	-	-	-
OUTLANDER MAX 650 EFI 15	0650-1330	-	-	-
OUTLANDER MAX 650 STD 4X4 12	0650-1329	-	-	-
OUTLANDER MAX 650 STD 4X4 13-14	0650-1330	-	-	-
OUTLANDER MAX 650 XT 4X4 12	0650-1329	-	-	-
OUTLANDER MAX 650 XT 4X4 13-14	0650-1330	-	-	-
OUTLANDER 800 XMR 12	0650-1329	-	-	-
OUTLANDER 800R EFI 15	0650-1330	-	-	-
OUTLANDER 800R EFI XMR 15	0650-1330	-	-	-
OUTLANDER 800R STD 4X4 12	0650-1329	-	-	-
OUTLANDER 800R STD 4X4 13-14	0650-1330	-	-	-
OUTLANDER 800R XT 4X4 12	0650-1329	-	-	-
OUTLANDER 800R XT 4X4 13-14	0650-1330	-	-	-
OUTLANDER MAX 800R EFI 15	0650-1330	-	-	-
OUTLANDER MAX 800R LTD 4X4 12	0650-1329	-	-	-
OUTLANDER MAX 800R STD 4X4 12	0650-1329	-	-	-
OUTLANDER MAX 800R STD 4X4 13-14	0650-1330	-	-	-
OUTLANDER MAX 800R XT 4X4 12	0650-1329	-	-	-
OUTLANDER MAX 800R XT 4X4 13-14	0650-1330	-	-	-
RENEGADE 800 12-15	0650-1330	-	-	-
RENEGADE 800 XXC 12-14	0650-1330	-	-	-
OUTLANDER 1000 EFI 15	0650-1330	-	-	-
OUTLANDER 1000 EFI 6X6 15	0650-1330	-	-	-
OUTLANDER 1000 EFI XMR 15	0650-1330	-	-	-
OUTLANDER 1000 STD 4X4 12-14	0650-1330	-	-	-
OUTLANDER 1000 XMR 13-14	0650-1330	-	-	-
OUTLANDER 1000 XT 4X4 12-14	0650-1330	-	-	-
OUTLANDER MAX 1000 EFI 15	0650-1330	-	-	-
OUTLANDER MAX 1000 EFI LTD 15	0650-1330	-	-	-
OUTLANDER MAX 1000 STD 4X4 13-14	0650-1330	-	-	-
OUTLANDER MAX 1000 XT 4X4 13-14	0650-1330	-	-	-
RENEGADE 1000 12-17	0650-1330	-	-	-
RENEGADE 1000 XXC 12-17	0650-1330	-	-	-
HONDA				
TRX90 93-19	0650-1360	-	-	0653-0094
ATC125M 86-87	-	-	-	0653-0095
ATC200X 83-85	-	0652-1681	-	0653-0069
ATC200X 86-87	-	-	-	0653-0069
TRX200 84	-	-	-	0653-0095
TRX200 90-91	0650-1283	-	-	0653-0095
TRX200 96	0650-1283	-	-	-
TRX200D 90-95	0650-1283	-	-	0653-0095
TRX200D 96-97	0650-1283	-	-	-
TRX200SX 86-88	0650-1284	-	-	0653-0095
ATC250ES 85-87	0650-1282	-	-	0653-0095
ATC250R 81-82	0650-1289	0652-1675	-	0653-0069
ATC250R 83-84	0650-1290	0652-1675	-	0653-0069
ATC250R 85	0650-1369	0652-1795	-	0653-0069
ATC250R 86	0650-1370	0652-1795	-	-
ATC250SX 85-86	0650-1282	-	-	0653-0095
ATC250SX 87	-	-	-	0653-0095
TRX250 FOURTRAX 85-87	0650-1282	-	-	0653-0095
TRX250 RECON 97-01	0650-1284	-	0653-0046	0653-0066
TRX250TE RECON 02-14	0650-1284	-	0653-0046	0653-0066
TRX250TE RECON 16-18	0650-1284	-	0653-0046	-
TRX250TM RECON 02-14	0650-1284	-	0653-0046	0653-0066
TRX250TM RECON 16	0650-1284	-	0653-0046	-
TRX300 FOURTRAX 88-92	0650-1286	-	0653-0068	0653-0070
TRX300 FOURTRAX 93-95	0650-1286	-	0653-0047	0653-0070
TRX300 FOURTRAX 96-00	0650-1286	-	0653-0047	-
TRX300FW FOURTRAX 4X4 88-92	0650-1286	-	0653-0068	0653-0070
TRX300FW FOURTRAX 4X4 93-95	0650-1286	-	0653-0047	0653-0070
TRX300FW FOURTRAX 4X4 96-00	0650-1286	-	0653-0047	-
TRX350 86-87	0650-1282	-	-	-
TRX350D 87-89	0650-1282	-	-	-
TRX350FE 00-06	0650-1287	-	0653-0048	0653-0050
TRX350FM FOURTRAX RANCHER 00-06	0650-1287	-	0653-0048	0653-0050

CONTROLS

FITS MODEL	THROTTLE PART #	CLUTCH PART #	REAR BRAKE PART #	REAR HAND PARK BRAKE PART #
CONTROL CABLES (CON'T)				
HONDA (CON'T)				
TRX350TE 00-06	0650-1287	-	0653-0048	0653-0050
TRX400FA 04-07	0650-1287	-	0653-0048	0653-0050
TRX400FW FOURTRAX FOREMAN 4X4 95-03	0650-1287	-	0653-0048	0653-0050
TRX400FGA FOURTRAX RANCHER 4X4 04-07	0650-1287	-	0653-0048	0653-0050
TRX400X 09-14	0650-1368	0652-1789	-	-
TRX420 FA 09-14	0650-1287	-	-	0653-0053
TRX420 FA IRS 15-17	-	-	-	0653-0055
TRX420 FE 07-13	0650-1287	-	0653-0048	0653-0054
TRX420 FE 14-17	-	-	-	0653-0055
TRX420 FM 07-13	0650-1287	-	0653-0048	0653-0054
TRX420 FM 14-17	-	-	-	0653-0055
TRX420 FPA 09-14	0650-1287	-	-	0653-0053
TRX420 FPE 11-13	0650-1287	-	0653-0048	0653-0054
TRX420 FPM 11-13	0650-1287	-	0653-0048	0653-0054
TRX420 TE 07-13	0650-1287	-	0653-0048	0653-0054
TRX420 TE 14-17	-	-	-	0653-0055
TRX420 TM 07-13	0650-1287	-	0653-0048	0653-0054
TRX420 TM 14-17	-	-	-	0653-0055
TRX450ES 98-01	0650-1287	-	0653-0048	0653-0050
TRX450FE/FM 02-04	0650-1287	-	0653-0048	0653-0050
TRX450S 98-01	0650-1287	-	0653-0048	0653-0050
TRX500FA 01-14	0650-1287	-	0653-0048	0653-0050
TRX500FA 15-17	-	-	0653-0048	-
TRX500FE 05-11	0650-1287	-	0653-0048	0653-0050
TRX500FE 12-13	0650-1287	-	0653-0049	0653-0056
TRX500FE 14-17	-	-	-	0653-0055
TRX500FGA 04-08	0650-1287	-	0653-0048	0653-0050
TRX500FM 05-09	0650-1287	-	0653-0048	0653-0050
TRX500FM 10-11	0650-1287	-	-	-
TRX500FM 12-13	0650-1287	-	0653-0049	0653-0056
TRX500FM 14-17	-	-	-	0653-0055
TRX500FPA 09-14	0650-1287	-	0653-0048	0653-0050
TRX500FPE 07-11	0650-1287	-	0653-0048	0653-0050
TRX500FPE 12-13	0650-1287	-	0653-0049	0653-0056
TRX500FPM 08-11	0650-1287	-	0653-0048	0653-0050
TRX500FPM 12-13	0650-1287	-	0653-0049	0653-0056
TRX500TM 05-06	0650-1287	-	0653-0048	0653-0050
TRX650 RINCON 03-05	0650-1287	-	-	0653-0057
TRX680 RINCON 06-17	0650-1287	-	-	0653-0057
KAWASAKI				
KFX50 07-17	0650-1334	-	-	-
KFX80 03-06	0650-1335	-	-	-
KFX90 07-17	0650-1334	-	-	-
KLT200B 83	-	0652-1788	-	-
KLT200C 83-84	-	0652-1788	-	-
KEF300 LAKOTA 95-03	-	-	-	0653-0073
KLF300A BAYOU 86-87	0650-1336	-	-	-
KLF300B BAYOU 88-05	0650-1336	-	0653-0071	0653-0074
KLF300C BAYOU 4X4 89-05	0650-1336	-	-	-
KVF300A PRAIRIE 4X4 99-02	0650-1337	-	0653-0072	0653-0075
KVF300B PRAIRIE 2X4 99-02	0650-1337	-	0653-0072	0653-0075
KVF360A & C PRAIRIE 4X4 03-13	0650-1338	-	0653-0058	0653-0060
KVF360B PRAIRIE 03-09	-	-	0653-0058	0653-0060
KVF400A PRAIRIE 4X4 97-98	0650-1337	-	0653-0072	0653-0075
KVF400B PRAIRIE 98	0650-1337	-	0653-0072	0653-0075
KVF400C PRAIRIE 4X4 99-02	0650-1337	-	0653-0072	0653-0075
KVF400D PRAIRIE 99-02	0650-1337	-	0653-0072	0653-0075
KLF400 BAYOU 93-99	0650-1337	-	-	0653-0075
KFX450R 08-14	0650-1340	0652-1787	-	-
KVF650 BRUTE FORCE 05-13	0650-1306	-	0653-0058	0653-0060
KVF650 BRUTE FORCE 06-13	0650-1341	-	0653-0059	0653-0061
KVF650 PRAIRIE 02-03	0650-1306	-	0653-0058	0653-0060
KFX 700 V-FORCE 04-09	0650-1306	-	0653-0058	0653-0060
KVF700 PRAIRIE 04-06	0650-1306	-	0653-0058	0653-0060
KVF750 BRUTE FORCE 05-07	0650-1341	-	0653-0059	0653-0061
KVF750 BRUTE FORCE 08-15	-	-	0653-0059	0653-0061
KVF750 BRUTE FORCE 16	-	-	0653-0059	0653-0061
KVF750 BRUTE FORCE EPS 12-15	-	-	0653-0059	0653-0061
KVF750 BRUTE FORCE EPS 16-17	-	-	0653-0059	0653-0061
POLARIS				
SPORTSMAN 90 07-16	0650-1324	-	-	-
PHOENIX 200 07-19	-	-	0653-0096	-
BIG BOSS 250 4X6 89-92	0650-1356	-	-	-
BIG BOSS 250 6X6 91-93	0650-1356	-	-	-

FITS MODEL	THROTTLE PART #	CLUTCH PART #	REAR BRAKE PART #	REAR HAND PARK BRAKE PART #
CONTROL CABLES (CONT)				
POLARIS (CONT)				
TRAIL BLAZER 250 90-98	0650-1356	-	-	-
TRAIL BLAZER 250 99-06	0650-1357	-	-	-
TRAIL BOSS 250 2X4 89-99	0650-1356	-	-	-
TRAIL BOSS 250 4X4 89-95	0650-1356	-	-	-
XPLORER 250 4X4 00-02	0650-1357	-	-	-
300 2X4/4X4 94-95	0650-1356	-	-	-
BIG BOSS 300 6X6 94	0650-1356	-	-	-
HAWKEYE 2X4 06-11	0650-1346	-	-	-
HAWKEYE 4X4 06-07	0650-1346	-	-	-
SPORTSMAN 300 4X4 08-10	0650-1346	-	-	-
XPRESS 300 98-99	0650-1352	-	-	-
HAWKEYE 325 2X4 15	0650-1608	-	-	-
MAGNUM 325 2X4 00	0650-1350	-	-	-
MAGNUM 325 2X4 01-02	0650-1346	-	-	-
MAGNUM 325 4X4 00-02	0650-1350	-	-	-
SPORTSMAN ETX EFI 325 15	0650-1608	-	-	-
TRAIL BOSS 325 00-01	0650-1350	-	-	-
TRAIL BOSS 325 02	0650-1346	-	-	-
XPEDITION 325 00-01	0650-1350	-	-	-
XPEDITION 325 02	0650-1346	-	-	-
ATP 330 4X4 04-05	0650-1346	-	-	-
MAGNUM 330 2X4 03-05	0650-1346	-	-	-
MAGNUM 330 4X4 05	0650-1346	-	-	-
MAGNUM 330 4X4 AA AB AC 03-04	0650-1346	-	-	-
MAGNUM 330 4X4 FB 03-04	0650-1346	-	-	-
TRAIL BLAZER 330 08-13	0650-1346	-	-	-
TRAIL BOSS 330 03-13	0650-1346	-	-	-
350L 2X4/4X4 93	0650-1354	-	-	-
BIG BOSS 350L 6X6 93	0650-1354	-	-	-
SPORTSMAN 350 4X4 93	0650-1354	-	-	-
TRAIL BOSS 350L 2X4/4X4 90-92	0650-1354	-	-	-
400L 2X4 94-95	0650-1354	-	-	-
400L 4X4 94	0650-1354	-	-	-
BIG BOSS 400L 6X6 94-97	0650-1354	-	-	-
HAWKEYE 400 HO 2X4 12-14	0650-1346	-	-	-
SPORTSMAN 400 4X4 94-97	0650-1354	-	-	-
SPORTSMAN 400 4X4 02-05	0650-1346	-	-	-
SPORTSMAN 400 4X4 AA AE AG 04	0650-1346	-	-	-
SPORTSMAN 400 4X4 AFTER 12-7-00 01	0650-1346	-	-	-
SPORTSMAN 400 4X4 AQ-AV 04	0650-1346	-	-	-
SPORTSMAN 400 4X4 BEFORE 12-7-00 01	0650-1346	-	-	-
SPORTSMAN 400 HO 4X4 08-14	0650-1346	-	-	-
TRAIL BLAZER 400 03	0650-1353	-	-	-
XPLORER 400L 4X4 99-02	0650-1353	-	-	-
XPEDITION 425 00	0650-1350	-	-	-
XPEDITION 425 01-02	0650-1346	-	-	-
SPORTSMAN 450 06-07	0650-1346	-	-	-
ATP 500 4X4 04-05	0650-1346	-	-	-
MAGNUM 500 2X4 HDS 02	0650-1346	-	-	-
MAGNUM 500 4X4 99-00	0650-1350	-	-	-
MAGNUM 500 4X4 01	0650-1346	-	-	-
MAGNUM 500 4X4 AA 02	0650-1346	-	-	-
MAGNUM 500 4X4 AB/FB 02	0650-1346	-	-	-
MAGNUM 500 4X4 HDS 03	0650-1346	-	-	-
MAGNUM 500 4X4 HDS AA 01-02	0650-1346	-	-	-
MAGNUM 500 4X4 HDS AB/FB 02	0650-1346	-	-	-
MAGNUM 500 4X4 HDS FB 01	0650-1346	-	-	-
SPORTSMAN 500 4X4 99-00	0650-1350	-	-	-
SPORTSMAN 500 4X4 DUSE 01	0650-1350	-	-	-
SPORTSMAN 500 4X4 DUSE 02	0650-1346	-	-	-
SPORTSMAN 500 4X4 HO 01	0650-1350	-	-	-
SPORTSMAN 500 4X4 HO 02-13	0650-1346	-	-	-
SPORTSMAN 500 4X4 HO AA- AC- AE- AG 04	0650-1346	-	-	-
SPORTSMAN 500 4X4 HO AD - AX 04	0650-1346	-	-	-
SPORTSMAN 500 4X4 RSE 99-01	0650-1350	-	-	-
SPORTSMAN 500 4X4 RSE 02	0650-1346	-	-	-
SPORTSMAN 500 6X6 00	0650-1350	-	-	-
SPORTSMAN 500 6X6 01-08	0650-1346	-	-	-
SPORTSMAN 500 EFI 09	0650-1346	-	-	-
WORKER 500 4X4 01	0650-1350	-	-	-
WORKER 500 4X4 99	0650-1350	-	-	-
SPORTSMAN 550 11-13	0650-1347	-	-	-
SPORTSMAN 550 EPS 10-14	0650-1347	-	-	-
SPORTSMAN 550 X2 10-14	0650-1347	-	-	-

CONTROLS

FITS MODEL	THROTTLE PART #	CLUTCH PART #	REAR BRAKE PART #	REAR HAND PARK BRAKE PART #
CONTROL CABLES (CON'T)				
POLARIS (CON'T)				
SPORTSMAN 550 XP 13-14	0650-1347	-	-	-
SPORTSMAN TOURING EPS 550 10-14	0650-1347	-	-	-
SPORTSMAN XP 550 09-10	0650-1347	-	-	-
SPORTSMAN 570 EFI 14-16	0650-1608	-	-	-
SPORTSMAN 570 EFI EPS 14-15	0650-1608	-	-	-
SPORTSMAN 570 EFI HD 14	0650-1608	-	-	-
SPORTSMAN 570 EFI UTE HD 15	0650-1608	-	-	-
SPORTSMAN 570 EFI X2 15	0650-1608	-	-	-
SPORTSMAN 570 HD 15	0650-1608	-	-	-
SPORTSMAN 570 SP 15-16	0650-1608	-	-	-
SPORTSMAN 570 SP TOURING 15	0650-1608	-	-	-
SPORTSMAN 570 TOURING EFI 14-15	0650-1608	-	-	-
SPORTSMAN 600 4X4 03-05	0650-1346	-	-	-
SPORTSMAN 700 4X4 02-06	0650-1346	-	-	-
SPORTSMAN 850 SP 15-16	0650-1343	-	-	-
SPORTSMAN TOURING 850 SP 15-16	0650-1343	-	-	-
SPORTSMAN TOURING EPS 850 10-14	0650-1343	-	-	-
SPORTSMAN TOURING EPS 850 HO 13	0650-1343	-	-	-
SPORTSMAN X2 850 11	0650-1343	-	-	-
SPORTSMAN XP 850 09-13	0650-1343	-	-	-
SPORTSMAN XP 850 EPS 10-14	0650-1343	-	-	-
SPORTSMAN 1000 XP 15	0650-1343	-	-	-
SPORTSMAN 1000 XP 16	0650-1347	-	-	-
SPORTSMAN TOURING 1000 15-16	0650-1343	-	-	-
SUZUKI				
LT-80 87-06	0650-1335	-	-	-
LT-230E 87-93	0650-1320	-	-	-
LT-230S 85-88	-	0652-1714	-	-
LT-250EF 85-86	0650-1322	-	-	-
LT-250S 89-90	-	0652-1714	-	-
LT-4WD 250 QUAD RUNNER 87-89	0650-1320	-	-	-
LT-4WD 250 QUAD RUNNER 90-98	0650-1316	-	-	-
LT-F250 2WD 00-01	0650-1317	-	-	-
LT-F250 2WD 90-98	0650-1316	-	-	-
LT-F250 2WD 99	0650-1309	-	-	-
LT-F250 OZARK 02-03	0650-1318	-	-	0653-0078
LT-F250 OZARK 04-08	-	-	-	0653-0078
LT-F250 OZARK 09-14	0650-1317	-	-	0653-0078
LT-F250F 4WD QUAD RUNNER 99-02	0650-1317	-	-	-
LT-F300F KING QUAD 99	0650-1316	-	-	-
LT-F300F KING QUAD 00-02	0650-1317	-	-	-
LT-F4WDX KING QUAD 300 91-98	0650-1316	-	-	-
LT-A400 2WD KING QUAD 08-09	-	-	0653-0076	-
LT-A400 EIGER 2WD 02-07	0650-1308	-	0653-0076	0653-0080
LT-A400F 4WD KING QUAD 08-10	0650-1315	-	0653-0076	-
LT-A400F 4WD KING QUAD 11-15	0650-1374	-	-	-
LT-A400F EIGER 4WD 03-07	0650-1308	-	0653-0076	0653-0080
LT-F400 2WD KING QUAD 08-09	0650-1315	-	0653-0076	-
LT-F400 EIGER 2WD 02-07	0650-1308	-	0653-0076	0653-0080
LT-F400F 4WD KING QUAD 08-10	0650-1315	-	0653-0076	-
LT-F400F 4WD KING QUAD 11-12	0650-1374	-	-	-
LT-F400F EIGER 4WD 02-07	0650-1308	-	0653-0076	0653-0080
LTA-450 X KING QUAD 10	0650-1304	-	-	-
LTA-450 X KING QUAD 10	0650-1304	-	-	0653-0081
LT-A500F QUAD MASTER AUTO 00-01	0650-1309	-	-	-
LT-A500F VINSON 02-04	0650-1308	-	-	-
LT-A500F VINSON 05-07	0650-1307	-	-	-
LT-A500X 09	0650-1310	-	-	-
LT-A500X 10-14	0650-1304	-	-	0653-0062
LT-A500X 15	0650-1304	-	-	-
LT-A500XP 15	0650-1304	-	-	-
LT-A500XP POWER STEERING 11-13	0650-1310	-	-	-
LT-F500F 98-02	0650-1309	-	0653-0077	-
LT-F500F VINSON 03-04	0650-1308	-	-	-
LT-F500F VINSON 05-07	0650-1307	-	-	-
LTV-700F TWIN PEAKS 04-06	0650-1306	-	0653-0058	0653-0058
LTA-750 X KING QUAD 10-14	0650-1304	-	-	0653-0062
LTA-750 XP KING QUAD POWER STEERING 11-14	0650-1310	-	-	-
YAMAHA				
YFM80 BADGER 92-01	0650-1301	-	-	0653-0085
YFM80 GRIZZLY 05-08	0650-1301	-	-	0653-0085
YFM100 89-91	0650-1301	-	-	-
YFM100 89-91	0650-1301	-	-	0653-0085
YFM200 MOTO-4 86-89	0650-1292	-	-	0653-0086
YFM225 MOTO-4 86-88	0650-1292	-	-	0653-0086

FITS MODEL	THROTTLE PART #	CLUTCH PART #	REAR BRAKE PART #	REAR HAND PARK BRAKE PART #
CONTROL CABLES (CON'T)				
YAMAHA (CON'T)				
YTM225 TRI-MOTO 86	0650-1362	-	-	-
YFB250 TIMBERWOLF 92-98	0650-1362	-	-	0653-0085
YFB250FW TIMBERWOLF 94-00	0650-1362	-	-	0653-0085
YFM250 BEARTRACKER 99-04	0650-1294	-	-	0653-0087
YFM250 BIG BEAR 07-09	0650-1295	-	-	0653-0087
YFM250 MOTO-4 89-91	0650-1292	-	-	0653-0086
YFM250B BRUIN 05-06	0650-1295	-	-	0653-0087
YTZ250 TRI MOTO 85	-	0652-1759	-	-
YFM350 GRIZZLY IRS 07-11	0650-1364	-	0653-0082	0653-0088
YFM350 WARRIOR 87-92	-	0652-1696	-	-
YFM350 WARRIOR 93-04	0650-1297	0652-1696	-	-
YFM350BA BRUIN 2WD 04-06	0650-1364	-	0653-0083	0653-0064
YFM350ER MOTO-4 87	0650-1292	-	-	0653-0086
YFM350ER MOTO-4 88-93	-	-	-	0653-0086
YFM350ER MOTO-4 94-95	0650-1297	-	-	0653-0086
YFM350FA BRUIN 4WD 04-06	0650-1364	-	0653-0083	0653-0064
YFM350FGW GRIZZLY 4WD 07-11	0650-1364	-	0653-0083	0653-0064
YFM350FGW GRIZZLY 4WD 12-14	0650-1364	-	-	0653-0064
YFM350FW BIG BEAR 87-92	-	-	-	0653-0089
YFM350FW BIG BEAR 93-96	0650-1294	-	-	0653-0089
YFM350FW BIG BEAR 97-99	-	-	-	0653-0090
YFM350FX WOLVERINE 95-05	0650-1294	-	-	-
YFM350GW GRIZZLY 2WD 07-11	0650-1364	-	0653-0083	0653-0064
YFM350U BIG BEAR 96-98	0650-1294	-	-	0653-0090
YFM350U BIG BEAR 99	-	-	-	0653-0090
YFM350X WOLVERINE 06-09	0650-1364	-	0653-0083	-
YFZ350 BANSHEE 87-09	0650-1296	0652-1797	-	-
YFM400 BIG BEAR 4WD 00-06	0650-1295	-	-	0653-0091
YFM400 BIG BEAR IRS 07-12	0650-1295	-	-	-
YFM400 BIG BEAR 2WD 00-04	0650-1295	-	-	0653-0091
YFM400 BIG BEAR IRS 07-12	0650-1295	-	0653-0084	-
YFM400 GRIZZLY IRS 07-08	0650-1364	-	-	0653-0092
YFM400 KODIAK 2WD 00-04	0650-1364	-	0653-0083	0653-0064
YFM400 KODIAK 4WD 93-99	0650-1294	-	-	0653-0090
YFM400 KODIAK 4WD 00-06	0650-1364	-	-	0653-0064
YFM400 KODIAK 4WD 00-06	0650-1364	-	-	0653-0092
YFM450 GRIZZLY EPS 11-14	0650-1364	-	-	-
YFM450 GRIZZLY IRS 07	0650-1364	-	-	0653-0092
YFM450 GRIZZLY IRS 08-14	0650-1364	-	-	-
YFM450 KODIAK 03-06	0650-1364	-	-	0653-0092
YFM450FX WOLVERINE 450 4X4 06-10	0650-1364	-	-	0653-0092
YFZ450 04-09	0650-1373	0652-1780	-	-
YFZ450 12-13	-	0652-1779	-	-
YFZ450R 09-17	0650-1366	0652-1778	-	-
YFZ450X 10-11	0650-1366	0652-1778	-	-
YFM550 GRIZZLY 09-12	0650-1291	-	-	0653-0065
YFM550 GRIZZLY 13	0650-1291	-	-	0653-0092
YFM550 GRIZZLY 14	0650-1364	-	-	0653-0065
YFM550 GRIZZLY EPS 09-13	0650-1291	-	-	0653-0065
YFM550 GRIZZLY EPS 14	0650-1364	-	-	0653-0065
YFM600 GRIZZLY 98-01	-	-	-	0653-0093
YFM600 GRIZZLY 02-08	0650-1367	-	-	-
YFM660R RAPTOR 01-05	0650-1363	0652-1777	-	-
KODIAK 700 EPS 4WD 16	0650-1291	-	-	0653-0065
YFM700 GRIZZLY 07-18	0650-1291	-	-	0653-0065
YFM700R RAPTOR 06-18	0650-1365	0652-1776	-	-

PLOWES

WINCHES

UTV

RACKS

IMPLEMENTS
& TOWING

LUGGAGE

BODY

CONTROLS

ELECTRICAL

WHEELS
& TIRESSUSPENSION
& DRIVE

BRAKING

ENGINE

RIDER

GARAGE

PROMO





PLOWS

WINCHES

UTV

RACKS

IMPLEMENTS
& TOWING

LUGGAGE

BODY

CONTROLS

ELECTRICAL

WHEELS
& TIRES

SUSPENSION
& DRIVE

BRAKING

ENGINE

RIDER

GARAGE

PROMO



PLOW LIGHT MOUNT KIT

Base made from steel. Light support arms made from 7-gauge steel. Great for night time, or early morning plowing. Attaches to front rack of ATV. Uses 28,6 mm (1 1/8") u-bolts. Made in the USA.

DESCRIPTION	PART #
PLOW LIGHT MOUNT KIT	2001-0116



STREET KIT/UTV

Complete kit with all the problems worked out for you - just follow the detailed/illustrated instructions and have a high-quality, professional installation. Comes with all the lights, turn signals, connections, horn, wiring and brackets you'll need. Universal fit and designed to fit most UTVs.

Kit utilizes the stock headlight and taillight assemblies for a clean, factory appearance and includes:

- 1) Steering column-mounted turn signal switch with integrated horn button.
- 2) Electronic flasher, six LED signal lights.
- 3) Complete wiring harnesses (all wires cut to length and connectors installed).
- 4) Snap-plug terminals wire ties.

NOTE: Converting off-road vehicles is not legal in all states. Check local regulations for specific requirements in your area.

DESCRIPTION	PART #
STREET KIT/ATV/UTV	2020-1752



UNIVERSAL STARTER SOLENOID

Fits universal solenoid for many ATVs and UTVs with round starter housings. Multiple connections for easy installation. Instructions included.

DESCRIPTION	PART #
UNIVERSAL STARTER SOLENOID	2110-0392



DUAL USB CHARGER WITH VOLTAGE MONITOR

Features 2 x USB charge ports with 2.1A output each. Has rubber plug to cover USB ports when not in use. Blue numeric readout monitors vehicles voltage in real time. Easy hook up.

DESCRIPTION	PART #
DUAL USB CHARGER W/ VOLTAGE MONITOR	2212-0723



POWER PORTS

Ideal for the ATV that needs an extra power outlet. All necessary wiring included. May be used as a plug-in for all types of 12-volt accessories. Includes an O-ring gasket and weather flap for protection against the elements. Works with any 12-volt battery. **NOTE: DO NOT USE AS A CIGARETTE LIGHTER.**

POWER PORTS	PART #
RECTANGULAR POWER PORT	MD-9100
ROUND POWER PORT	2120-0639



BACK UP ALARM

Beeps when vehicle is in reverse. Easy installation and mounting. Small, space-saving design.

DESCRIPTION	PART #
BACK UP ALARM	2107-0229



DUAL HORN

Loud two-horn set. Dual tone - high and low. Zinc-plated to avoid corrosion. Consistent sound. Protective grill over bell to keep mud and debris out. Easy to install, mounting brackets included. Horn button with wires available separately.

DESCRIPTION	PART #
DUAL HORN	2107-0230
HORN BUTTON	2107-0247



UNIVERSAL ROCKER SWITCH

Universal 2 prong switch. Contact resistance: 50 m ohm max insulation resistance: DC 500-volt 100M ohm min.

DESCRIPTION	PART #
UNIVERSAL ROCKER SWITCH	0616-0241



TURN SIGNAL ROCKER SWITCH

LED back light for night riding. Designed for tough off-road use. Common size will fit most panels (can be flush mounted in dash). Sold each.

DESCRIPTION	PART #
TURN SIGNAL ROCKER SWITCH	2106-0476



MAP LIGHT

Map light for night driving. Common size will fit most panels (can be flush mounted in dash). Simple touch to turn on/off.

DESCRIPTION	PART #
MAP LIGHT	2106-0443

BLUETOOTH® AUDIO RECEIVER/CONTROLLER

Receives music wirelessly via Bluetooth® and sends to "aux in" on existing radio using 3.2 mm (1/8") male plug. Can easily send music directly to an amplifier using supplied RCA Y Jack adaptor when no existing radio is present. Unit has a 3.2 mm (1/8") input for other audio devices such as GPS or Sat. radio. Single control knob for easy operation. Power on/off, control volume, track and play/pause with ease while riding. Flush mount design easily snaps into common rocker switch opening in most UTV dashboards/consols.



DESCRIPTION	PART #
BLUETOOTH® AUDIO RECEIVER/CONTROLLER	4401-0206



0616-0328



2106-0446

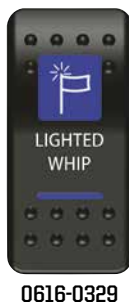

0616-0329



2106-0447



0616-0330



2106-0448



0616-0331



0616-0452



2106-0414



2106-0413



2106-0415



2106-0449



2106-0416



2106-0450



2106-0417



2106-0451



2106-0453



2106-0454



2106-0455



2106-0456

ROCKER SWITCHES

LED back light for night riding. Common size will fit most panels (can be flush mounted in dash). Grip button for ease of use while in rough terrain. Sold as each.

DESCRIPTION	COLOR	PART #	DESCRIPTION	COLOR	PART #L
LED LIGHT BAR	BLUE	0616-0328	HEATER	BLUE	2106-0415
	RED	2106-0446		RED	2106-0449
WHIP LIGHT	BLUE	0616-0329	ROOF LIGHT	BLUE	2106-0416
	RED	2106-0447		RED	2106-0450
STEREO	BLUE	0616-0330	ZOMBIE LGHT	BLUE	2106-0417
	RED	2106-0448		RED	2106-0451
WINCH	BLUE	0616-0331	ROCK LIGHTS	BLUE	2106-0453
	RED	2106-0452		RED	2106-0454
ON/OFF	BLUE	2106-0414	FAN	BLUE	2106-0455
	RED	2106-0413		RED	2106-0456



RESETTABLE HOUR/TACH METER

Three resettable service alarms which include, "clean air filter", "change oil" and "valve service." Time mode allows you to record running time periods, but easily resets with the touch of a button. No power or ground wires required. Larger display makes it easier to read. Works on all gasoline engines. Includes double-sided tape, screws and fasteners. Log book included.

DESCRIPTION	PART #
RESETTABLE HOUR METER	2212-0406



HOUR METER & HOUR/TACH METER

Keeps track of times for your oil changes, valve adjustments, spark plugs, etc. Usable with any gas engine. Records/displays up to 9,999.9 hours. Peel and stick or can be permanently mounted. Connect to spark plug wire. Hours automatically roll over. Log book included.

DESCRIPTION	PART #
HOUR METER	2212-0026
HOUR/TACH METER	2212-0405



WIRELESS HOUR METER

The most advanced, accurate and reliable hour meter made and the quickest to install. Automatically starts/stops from the running of your engine by sensing the resonance of the motor. No wiring required - just peel and stick. Includes resettable trip and total hours accumulated modes. Waterproof and shock resistant with a built in battery lifespan of 5-7 years. Comes with a log book to track the service life, oil changes, valve adjustments, spark plugs and settings, etc. Records and displays up to 9,999.9 hours. Push button to display data when engine is not running. Works on ATV/UTV, motorcycle or PWC automatically. 2 or 4-stroke. Made with solid-state electronics, modern LCD and ROHS compliant components. CE certified and IP-68 rating. Made in the USA.

DESCRIPTION	PART #
WIRELESS HOUR METER	2212-0426



CIRCUIT BREAKERS

Exact replacements by the original manufacturers. 10A and 20A circuit breakers. Available for most Polaris ATV/UTV models.

FITS MODEL	PART #
POLARIS	
TRAIL BLAZER 250 97-06	2130-0241
XPLORER 250 00-01	2130-0241
TRAIL BOSS 00-02	2130-0240
XPLORER 250 00-02	2130-0240
XPLORER 300 96-99	2130-0241
XPRESS 300 96-99	2130-0241
SPORTSMAN ETX 15	2130-0243
MAGNUM 325 00-02	2130-0241
MAGNUM 325 00-02	2130-0240
XPEDITION 325 00-02	2130-0240
ATP 330 04	2130-0241
MAGNUM 330 03-04	2130-0241
ATP 330 04	2130-0240
TRAIL BOSS 330 03-07	2130-0240
SPORTSMAN 335 99-00	2130-0241
WORKER 335 99-01	2130-0241
SPORTSMAN 335 00	2130-0240
HAWKEYE 400 11-14	2130-0243
SPORTSMAN 400 HO 11-14	2130-0243
SPORTSMAN 400 01-04	2130-0241
SPORTSMAN 400L 96-97	2130-0241
TRAIL BLAZER 400 03	2130-0241
XPLORER 400 96-02	2130-0241
XPRESS 400 96-97	2130-0241
SPORTSMAN 400 01-03	2130-0240
TRAIL BLAZER 400 03	2130-0240
XPLORER 400 00-02	2130-0240
MAGNUM 425 95-98	2130-0241
XPEDITION 425 00-02	2130-0241
XPEDITION 425 00-02	2130-0240
SPORTSMAN 450 16	2130-0243
RANGER 500 08-10	2130-0243
SPORTSMAN 500 08-13	2130-0243
ATP 500 04	2130-0241
MAGNUM 500 99-02	2130-0241
SPORTSMAN 500 96-04	2130-0241
WORKER 500 99-01	2130-0241
XPLORER 500 97	2130-0241
MAGNUM 500 00-02	2130-0240
SPORTSMAN 500 00-03	2130-0240
WORKER 500 01	2130-0240
SPORTSMAN 550 09-14	2130-0243
RANGER 570 16-18	2130-0244
RZR 570 17-18	2130-0244
SPORTSMAN 570 14-17	2130-0243
RZR 570 12-16	2130-0242
SPORTSMAN 600 03-04	2130-0241
RANGER 700 07	2130-0242
SPORTSMAN 700 X2 08	2130-0242
SPORTSMAN 700 03-07	2130-0241
RANGER 800 10-14	2130-0242
RZR 800 08-14	2130-0242
SPORTSMAN 800 08-14	2130-0242
SPORTSMAN 800 05-07	2130-0241
SCRAMBLER 850 14-18	2130-0244
SPORTSMAN 850 14-18	2130-0244
SPORTSMAN 850 XP 09-10	2130-0242
SPORTSMAN 850 XP 11-13	2130-0243
ACE 900 16-18	2130-0244
RZR 900 15-18	2130-0244
RANGER 900 DIESEL 11-14	2130-0242
RANGER 900 XP 13-18	2130-0242
RZR 900 11-14	2130-0242
RANGER 1000 DIESEL 15-18	2130-0244
RZR 1000 (ALL) 14-16	2130-0244
RZR 1000 60" ONLY 17-18	2130-0244
RANGER 1000 XP 17-18	2130-0242

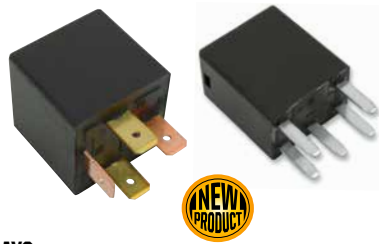

RELAYS

Direct replacement relays by the original manufacturers, not reproduction units. Each relay is the exact same voltage and amperage for a worry-free installation. These relays are used to control functions like the fuel pump, power steering, cooling fan, EFI, etc. Most machines use multiple relays and are located in the fuse box.

FITS MODEL	PART #
RELAYS	
ARCTIC CAT	
366 ATV 08-11	2130-0262
400 ATV 04-17	2130-0262
450 ATV 10-16	2130-0262
500 ATV 04-14	2130-0262
PROWLER 500 14-18	2130-0262
PROWLER 550 15	2130-0262
550 ATV 14-17	2130-0262
650 ATV 04-08	2130-0262
PROWLER 650 06-09	2130-0262
PROWLER 700 13-17	2130-0262
700 ATV 07-08	2130-0262
700 ATV 13-14	2130-0262
1000 ATV 10-17	2130-0262
PROWLER 1000 15-17	2130-0262
WILDCAT XX 1000 18-19	2130-0262
CAN-AM	
OUTLANDER 400 11-14	2130-0264
OUTLANDER 450 15-18	2130-0263
OUTLANDER 450 15-18	2130-0264
OUTLANDER 500 10-15	2130-0263
RENEGADE 500 10-15	2130-0263
OUTLANDER 500 07-15	2130-0264
RENEGADE 500 11-15	2130-0264
OUTLANDER 570 16-18	2130-0263
RENEGADE 570 16-17	2130-0263
OUTLANDER 570 16-18	2130-0264
RENEGADE 570 16-18	2130-0264
OUTLANDER 650 10-17	2130-0263
OUTLANDER 650 06-18	2130-0264
COMMANDER 800 11-17	2130-0263
DEFENDER 16-17	2130-0263
OUTLANDER 800 10-15	2130-0263
RENEGADE 800 12-15	2130-0263
COMMANDER 800 11-18	2130-0264
OUTLANDER 800 06-15	2130-0264
RENEGADE 800 07-15	2130-0264
OUTLANDER 850 16-18	2130-0263
RENEGADE 850 16-17	2130-0263
OUTLANDER 850 16-18	2130-0264
RENEGADE 850 16-18	2130-0264
COMMANDER 1000 11-17	2130-0263
MAVERICK 1000 13-17	2130-0263
OUTLANDER 1000 12-17	2130-0263
RENEGADE 1000 12-17	2130-0263
COMMANDER 1000 11-18	2130-0264
DEFENDER 16-18	2130-0264
MAVERICK/X3 1000 13-18	2130-0264
OUTLANDER 1000 13-18	2130-0264
RENEGADE 1000 12-18	2130-0264
POLARIS	
ACE 150 17-18	2130-0258
ACE 325 14-16	2130-0258
RANGER ETX 15-16	2130-0258
RANGER 400 11-14	2130-0258
HAWKEYE 400 11-14	2130-0256
SPORTSMAN 400 11-14	2130-0256
RANGER 400 10-14	2130-0260
SPORTSMAN 450 16-19	2130-0258

FITS MODEL	PART #
RELAYS (CON'T)	
POLARIS (CON'T)	
RANGER 500 08	2130-0256
RANGER 500 09-13	2130-0258
SPORTSMAN 500 (ALL MODELS) 08-13	2130-0256
SCRAMBLER 500 10-12	2130-0257
SPORTSMAN 500 EFI 08-09	2130-0257
SPORTSMAN 550 09-14	2130-0258
ACE 570 15-19	2130-0258
RANGER 570 14-19	2130-0258
RZR 570 12-19	2130-0258
SPORTSMAN 570 14-19	2130-0258
RANGER 700 09	2130-0258
RANGER 700 07-09	2130-0256
SPORTSMAN 700 05-07	2130-0256
RANGER 700 09	2130-0257
RZR 800 08-09	2130-0259
RZR-S 800 09	2130-0259
RANGER 800 10-16	2130-0258
RZR 800 10-14	2130-0258
SPORTSMAN 800 (ALL MODELS) 05-14	2130-0256
RANGER 800 10-14	2130-0257
RZR 800 08-10	2130-0260
RZR-S 800 09	2130-0260
SCRAMBLER 850 13-18	2130-0258
SPORTSMAN 850 09-19	2130-0258
ACE 900 16-19	2130-0258
RANGER 900 XP 13-19	2130-0258
RZR 900 11-19	2130-0258
RANGER 900 DIESEL 11-14	2130-0257
RANGER 900 XP 15-16	2130-0257
RANGER 900 DIESEL 11-14	2130-0260
BRUTUS 14-18	2130-0258
GENERAL 1000 16-18	2130-0258
RANGER 1000 DIESEL 15-18	2130-0258
RANGER 1000 XP 17-18	2130-0258
RANGER HST 15-17	2130-0258
RZR 1000 14-19	2130-0258
RZR TURBO 16-18	2130-0258
SCRAMBLER 1000 14-18	2130-0258
SPORTSMAN 1000 15-19	2130-0258
BRUTUS 13-18	2130-0257
RANGER HST 14-17	2130-0257
BRUTUS 13-18	2130-0260
RANGER 1000 DIESEL 15-18	2130-0260
RANGER EV 10-17	2130-0260
GENERAL 1000 18-19	2130-0261
RANGER 1000 XP 18-19	2130-0261
RS1 18-19	2130-0261
RZR 1000 XP 19	2130-0261
RZR TURBO 19	2130-0261



BATTERY ISOLATOR KIT

Let your secondary battery power your winch, stereo or lights. 140 Amp smart battery isolator. Complete kit with all necessary wiring and connectors.

DESCRIPTION	PART #
BATTERY ISOLATOR KIT	2113-0646



OPTIMATE 1 DUO BATTERY CHARGER/MAINTAINER

- Maintain any type of 12 volt lead-acid battery without overcharging, filler cap / wet cell, sealed AGM (MF) or GEL and 12.8/13.2V lithium (LiFePO4) batteries.
- OptiMate 1 delivers precise micro processor controlled charging and long term maintenance.
- 4-step 12V/12.8V 0.6A Battery charger-maintainer
- Ideal for vehicles that are seldom or seasonally used, or in storage.
- 100% automatic, 100% safe long-term battery care. Connect and forget, no more battery problems!
- For the batteries of the past and the future
- The "no brainer" battery maintainer. No need to choose, the charger decides the right program.
- Charge time limit Safe to leave connected for seasonal maintenance
- Size 4 x 2 1/2 x 3 inches (100 x 63 x 76mm)
- Meets all relevant EN and IEC norms and CE directives, CE conformity, EU plug available, Manufactured by Optimate for Moose Racing
- Includes: SAE-71 permanent ringlet connector with weatherproof cap, SAE-74 set of battery clips

DESCRIPTION	PART #
OPTIMATE 1 BATTERY CHARGER (EU PLUG)	3807-0492
REPLACEMENT EYELET CONNECTOR	3807-0259



OPTIMATE 6 BATTERY CHARGER/MAINTAINER

Saves batteries other chargers can't, because it recognizes the difference between a discharged battery that needs charging and a dead flat sulfated battery that needs saving. Perfect for months-long maintenance of any size 12-volt lead-acid battery. Power saving stand-by mode. Full electronic protection against errors. Automatic multi-step program. Multi-stage desulfation: Restores neglected batteries from as low as 0.5 volts. Ampmatic charge control adjusts current to suit any battery size / condition for fastest and most complete charge. Cell voltage balancing mode correctly prepares NEW batteries for first use and optimizes battery performance. Daily battery condition tests. Interactive float charge maintains battery fully charged, weeks or months long. Global input (100-240V 50-60Hz), high efficiency (CEC listed), fully sealed.

Includes two detachable, interchangeable battery connectors: a connector with eyelets for permanent connection and battery clips for bench charging.

Meets all relevant EN and IEC norms and CE directives.

CE conformity. EU & UK plug available. Manufactured by Optimate for Moose.

DESCRIPTION	PART #
OPTIMATE 6 BATTERY CHARGER/MAINTAINER (EU PLUG)	3807-0272
OPTIMATE 6 BATTERY CHARGER/MAINTAINER (UK PLUG)	3807-0387



OPTIMATE 3 BATTERY CHARGER/MAINTAINER

Suitable for all types of 12-volt lead-acid batteries of rated capacity from 3 to 50Ah. Diagnoses sulfated battery condition. Recovers severely neglected batteries from as low as 2 volts. Automatic hourly test, advance warning of problems. Interactive float charge, max 800mA possible. No risk of overcharging. Totally safe for vehicle electronics. Sparks suppressed. Safe for long-term battery maintenance. Automatic shut-down if short-circuited or battery disconnected. Global input (100-240V 50-60Hz), high efficiency (CEC listed), fully sealed.

Includes two detachable, interchangeable battery connectors: a connector with eyelets for permanent connection and battery clips for bench charging.

Meets all relevant EN and IEC norms and CE directives.

CE conformity. EU & UK plug available. Manufactured by Optimate for Moose.

DESCRIPTION	PART #
OPTIMATE 3 BATTERY CHARGER/MAINTAINER (EU PLUG)	3807-0271

01 PERMANENT BATTERY LEAD

Weatherproof cap. Cable Tmin: -40°F/40°C. Moulded ringlets. Will work with Moose OptiMate 3 and OptiMate 6 battery chargers.

DESCRIPTION	PART #
01 PERMANENT BATTERY LEAD	3807-0259



JAR OF EYELET CONNECTORS

- Jar of 20 premium quick connector permanent battery leads
- Weather-protected connection system and cable
- Industry standard 2-pin SAE connector
- Length 51 cm (20"); eyelet diameter 6 mm (1/4") and M6 weather-protected 15A fuse
- -40 °C (-40 °F) very low temperature use
- Cable remains flexible at below freezing temperatures
- Rubber sealing cap and shroud for OptiMate heavy-duty SAE connector.



DESCRIPTION	PART #
OPTIMATE 6 BATTERY CHARGER/MAINTAINER	3807-0353

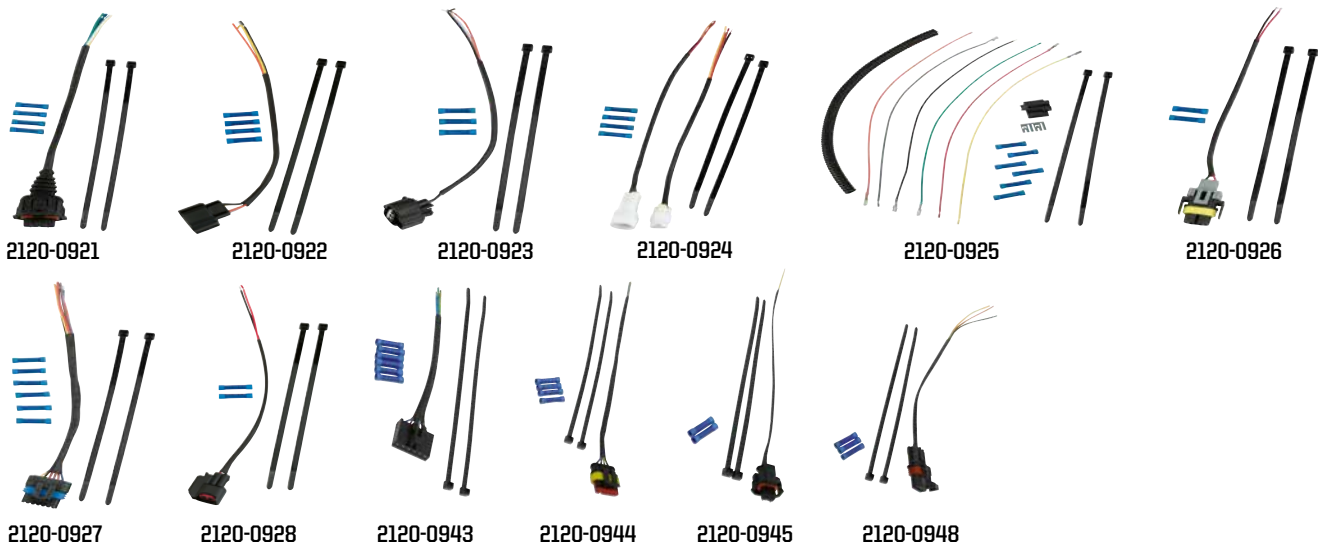

LEFT HANDLEBAR CONTROLS PIGTAIL HARNESS

If the switches on your left handlebar cluster quit working or are erratic, check the terminals and plug.

HEADLIGHT PIGTAIL HARNESS

If you broke the headlight connector we can help. This direct replacement plug fits a huge number of Ranger models and will get your headlights working again. Our pigtail fits perfectly to the headlight bulb and has a nice wire sheathing protecting the wires going into the plug. The wires are 229 mm (9") long.

TRANSMISSION SENSOR PIGTAIL HARNESS

Our pigtail fits perfectly to the transmission sensor and has 229 mm (9") long wire leads.

FUEL INJECTOR PIGTAIL HARNESS

If you are getting a fuel injector code, it could be the plug and wires. Our pigtail fits perfectly to the fuel injector and has 152 mm (6") long wire leads.

KEIHIN THROTTLE SENSOR PIGTAIL HARNESS

Fix it now with our own version of the harness repair kit for all Keihin throttle bodies.

MIKUNI THROTTLE SENSOR PIGTAIL HARNESS

Our pigtail fits perfectly to the Mikuni TPS sensor and has 152 mm (6") long wire leads.

IDLE AIR CONTROL VALVE PIGTAIL HARNESS

Wires either internally or externally and can be hard to diagnose. Many times it will throw a code but not always.

T-MAP SENSOR PIGTAIL HARNESS

The wire harness to the T-map sensor is a well-known issue on Polaris EFI machines. Simply cut off the old harness and use the included butt connectors or solder the connections to the new pigtail.

POLARIS SPORTSMAN IGNITION KEYSWITCH PIGTAIL HARNESS

Connectors to the Polaris ATV ignition switches are prone to corroding. Cut off the old harness and use the included butt connectors or solder the connections to the new pigtail. Fits perfect to the ignition switch with a wire sheathing protecting the wires into the plug. 152 mm (6") long wires fix to the inside of the headlight pod. Sold each; includes butt connectors and zip ties.

POLARIS RZR FUEL PUMP PIGTAIL HARNESS

Wires can vibrate over time and break internally or externally. Cut off the old plugs and use the included butt connectors or solder the connections to the new pigtail. Fits perfectly to the fuel pump with 229 mm (9") long wire leads.

POLARIS TEMP SENSOR PIGTAIL HARNESS

Fits the EFI temp sensor on just about every EFI Polaris ATV or UTV. Includes 254 mm (10") long pigtail, two zip ties and two butt connectors. Cut out the old harness, splice in the new one and plug it into the sensor.

POLARIS RANGER PULSE BUSBAR PIGTAIL HARNESS

Replace the broken wire with our harness.

FITS MODEL	LEFT HANDLEBAR CONTROLS PIGTAIL HARNESS	HEADLIGHT PIGTAIL HARNESS	TRANSMISSION SENSOR PIGTAIL HARNESS	FUEL INJECTOR PIGTAIL HARNESS	KEIHIN THROTTLE SENSOR PIGTAIL HARNESS	MIKUNI THROTTLE SENSOR PIGTAIL HARNESS	IDLE AIR CONTROL VALVE PIGTAIL HARNESS	T-MAP SENSOR PIGTAIL HARNESS	POLARIS SPORTSMAN IGNITION KEYSWITCH PIGTAIL HARNESS	POLARIS RZR FUEL PUMP PIGTAIL HARNESS	POLARIS TEMP SENSOR PIGTAIL HARNESS	POLARIS RANGER PULSE BUSBAR PIGTAIL HARNESS
OEM REPLACEMENT PIGTAIL HARNESSES												
ARCTIC CAT												
400 DVX 04-08	-	2120-0927	-	-	-	-	-	-	-	-	-	-
400 4X4 (ALL MODELS) 05-14	-	2120-0927	-	-	-	-	-	-	-	-	-	-
500 4X4 (ALL MODELS) 05-15	-	2120-0927	-	-	-	-	-	-	-	-	-	-
550 4X4 (ALL MODELS) 09-15	-	2120-0927	-	-	-	-	-	-	-	-	-	-
650 4X4 (ALL MODELS) 05-10	-	2120-0927	-	-	-	-	-	-	-	-	-	-
700 4X4 (ALL MODELS) 06-12	-	2120-0927	-	-	-	-	-	-	-	-	-	-
1000 4X4 (ALL MODELS) 09-17	-	2120-0927	-	-	-	-	-	-	-	-	-	-
PROWLER 500 14-15	-	2120-0927	-	-	-	-	-	-	-	-	-	-
PROWLER 550 09-14	-	2120-0927	-	-	-	-	-	-	-	-	-	-
PROWLER 650 06-09	-	2120-0927	-	-	-	-	-	-	-	-	-	-
PROWLER 700 08-11	-	2120-0927	-	-	-	-	-	-	-	-	-	-
POLARIS												
TRAIL BLAZER 250 02-06	-	-	-	-	-	-	-	-	2120-0943	-	-	-
HAWKEYE (ALL) 04-15	-	-	-	-	-	-	-	-	2120-0943	-	-	-
HAWKEYE 300 06-14	-	-	2120-0926	-	-	-	-	-	-	-	-	-
HAWKEYE 300 06-15	-	2120-0927	-	-	-	-	-	-	-	-	-	-
HAWKEYE 300 11-14	2120-0928	-	-	-	-	-	-	-	-	-	-	-
SPORTSMAN 300 08-10	-	2120-0927	2120-0926	-	-	-	-	-	-	-	-	-
SPORTSMAN 300 08-10	-	-	-	-	-	-	-	-	2120-0943	-	-	-
ACE 325 14-16	-	2120-0927	-	-	-	2120-0923	-	2120-0921	2120-0943	-	2120-0945	-
MAGNUM 325 00-02	2120-0928	-	-	-	-	-	-	-	-	-	-	-
MAGNUM 325 02	-	-	-	-	-	-	-	-	2120-0943	-	-	-
SPORTSMAN ETX 15	-	-	-	-	-	-	-	-	2120-0943	2120-0944	2120-0945	-
SPORTSMAN ETX 325 15	2120-0928	2120-0927	-	-	-	2120-0923	-	-	-	-	-	-

FITS MODEL	LEFT HANDLEBAR CONTROLS PIGTAIL HARNESS	HEADLIGHT PIGTAIL HARNESS	TRANSMISSION SENSOR PIGTAIL HARNESS	FUEL INJECTOR PIGTAIL HARNESS	KEIHIN TPS SENSOR PIGTAIL HARNESS	MIKUNI THROTTLE SENSOR PIGTAIL HARNESS	IDLE AIR CONTOL VALVE PIGTAIL HARNESS	T-MAP SENSOR PIGTAIL HARNESS	POLARIS SPORTSMAN IGNITION KEYSWITCH PIGTAIL HARNESS	POLARIS RZR FUEL PUMP PIGTAIL HARNESS	POLARIS TEMP SENSOR PIGTAIL HARNESS	POLARIS RANGER PULSE BUSBAR PIGTAIL HARNESS
OEM REPLACEMENT PIGTAIL HARNESSES (CON'T)												
POLARIS (CON'T)												
TRAILBOSS 325/330 00-09	2120-0928	-	-	-	-	-	-	-	-	-	-	-
XPEDITION 325 01-02	-	-	-	-	-	-	-	-	2120-0943	-	-	-
XPEDITION 325/425 02	2120-0928	-	-	-	-	-	-	-	-	-	-	-
ATP 330 04-05	-	-	-	-	-	-	-	-	2120-0943	-	-	-
ATP 330/500 04-05	2120-0928	-	2120-0926	-	-	-	-	-	-	-	-	-
MAGNUM 330 03-06	2120-0928	-	2120-0926	-	-	-	-	-	-	-	-	-
MAGNUM 330 03-06	-	-	-	-	-	-	-	-	2120-0943	-	-	-
TRAIL BLAZER 330 08-13	-	-	-	-	-	-	-	-	2120-0943	-	-	-
TRAIL BOSS 330 03-07	-	-	-	-	-	-	-	-	2120-0943	-	-	-
TRAIL BOSS 330 10-13	-	2120-0927	-	-	-	-	-	-	-	-	-	-
SPORTSMAN 335 00	2120-0928	-	-	-	-	-	-	-	-	-	-	-
RANGER 400 10-14	-	2120-0927	2120-0926	-	-	-	-	-	-	-	-	-
RANGER 400 10-14	-	-	-	-	-	-	-	-	2120-0943	-	-	-
SCRAMBLER 400 02	-	-	-	-	-	-	-	-	2120-0943	-	-	-
SPORTSMAN 400 01-05	2120-0928	-	-	-	-	-	-	-	-	-	-	-
SPORTSMAN 400 02-05	-	2120-0927	-	-	-	-	-	-	-	-	-	-
SPORTSMAN 400 02-05	-	-	-	-	-	-	-	-	2120-0943	-	-	-
SPORTSMAN 400 04-05	-	-	2120-0926	-	-	-	-	-	-	-	-	-
SPORTSMAN 400 HO 08-14	2120-0928	-	2120-0926	-	-	-	-	-	-	-	-	-
SPORTSMAN 400 HO 08-14	-	-	-	-	-	-	-	-	2120-0943	-	-	-
SPORTSMAN 400 HO 11-14	-	2120-0927	-	-	-	-	-	-	-	-	-	-
TRAIL BLAZER 400 03	-	-	-	-	-	-	-	-	2120-0943	-	-	-
TRAIL BOSS 02	-	-	-	-	-	-	-	-	2120-0943	-	-	-
XPLORER 400 02	-	-	-	-	-	-	-	-	2120-0943	-	-	-
XPLORER 400 99-02	2120-0928	-	-	-	-	-	-	-	-	-	-	-
XPEDITION 425 01-02	-	-	-	-	-	-	-	-	2120-0943	-	-	-
SPORTSMAN 450 06-07	2120-0928	2120-0927	2120-0926	-	-	-	-	-	-	-	-	-
SPORTSMAN 450 06-07	-	-	-	-	-	-	-	-	2120-0943	-	-	-
SPORTSMAN 450 16	-	-	-	2120-0925	-	-	-	-	-	-	-	-
SPORTSMAN 450 16-18	2120-0928	2120-0927	-	-	-	2120-0923	-	-	-	-	-	-
SPORTSMAN 450 16-18	-	-	-	-	-	-	-	-	2120-0944	2120-0945	-	-
SPORTSMAN 450 HO 16-18	-	-	-	-	-	-	-	2120-0943	-	-	-	-
ACE 500 17-19	-	-	-	-	-	-	-	2120-0921	-	-	2120-0945	-
ATP 500 04-05	-	2120-0927	-	-	-	-	-	-	-	-	-	-
ATP 500 04-05	-	-	-	-	-	-	-	-	2120-0943	-	-	-
MAGNUM 500 00-02	2120-0928	-	-	-	-	-	-	-	-	-	-	-
MAGNUM 500 02	-	2120-0927	-	-	-	-	-	-	-	-	-	-
MAGNUM 500 02-03	-	-	-	-	-	-	-	-	2120-0943	-	-	-
RANGER 500 (EFI MODELS ONLY) 06-13	-	-	-	-	-	2120-0923	2120-0922	-	-	-	-	-
RANGER 500 04-13	-	-	-	-	-	-	-	-	2120-0943	-	-	-
RANGER 500 08-13	-	2120-0927	-	-	-	-	-	-	-	-	-	-
RANGER 500 99-13	-	-	2120-0926	-	-	-	-	-	-	-	-	-
RANGER 500 EFI 08	-	-	-	-	-	-	-	-	-	-	2120-0945	-
RANGER SERIES 10	-	-	-	-	-	-	-	-	2120-0943	-	-	-
RANGER SERIES 11	-	-	-	-	-	-	-	-	2120-0943	-	-	-
RANGER TM 04-06	-	-	-	-	-	-	-	-	2120-0943	-	-	-
RANGER TM 325 04-06	-	-	-	-	-	-	-	-	-	-	-	-
SCRAMBLER 500 02-12	-	-	-	-	-	-	-	-	2120-0943	-	-	-
SCRAMBLER 500 99-09	2120-0928	-	-	-	-	-	-	-	-	-	-	-
SPORTSMAN 500 (EFI ONLY) 06-09	-	-	-	-	-	2120-0923	-	-	-	-	-	-
SPORTSMAN 500 00-13	2120-0928	-	-	-	-	-	-	-	-	-	-	-
SPORTSMAN 500 02-13	-	2120-0927	-	-	-	-	-	-	-	-	-	-
SPORTSMAN 500 02-13	-	-	-	-	-	-	-	-	2120-0943	-	-	-
SPORTSMAN 500 04-13	-	-	2120-0926	-	-	-	-	-	-	-	-	-
SPORTSMAN 500 EFI 06-07	-	-	-	-	-	-	2120-0922	-	-	-	-	-
SPORTSMAN 550 (ALL MODELS) 09-14	-	-	-	-	-	2120-0923	-	-	-	-	-	-
SPORTSMAN 550 09-14	2120-0928	2120-0927	2120-0926	-	-	-	2120-0922	-	-	-	-	-
SPORTSMAN 550 11-14	-	-	-	-	-	-	-	-	-	2120-0944	-	-
SPORTSMAN 550 XP 09-14	-	-	-	-	-	-	-	-	2120-0943	-	-	-
ACE 570 15	-	-	-	-	-	2120-0923	-	-	-	-	-	-
ACE 570 15-18	-	2120-0927	-	2120-0925	-	-	-	2120-0921	-	-	-	-
ACE 570 15-19	-	-	-	-	-	-	-	-	-	-	2120-0945	-
ACE 570 16-18	-	-	-	-	-	-	-	-	2120-0943	-	-	-
RANGER 570 14	-	-	-	-	-	2120-0923	-	-	-	-	-	-
RANGER 570 14-18	-	2120-0927	-	2120-0925	-	-	-	-	-	-	-	-
RANGER 570 14-19	-	-	-	-	-	-	-	-	2120-0943	2120-0944	2120-0945	-
RZR 570 12-16	-	-	-	-	-	2120-0923	2120-0922	-	-	-	-	-
RZR 570 12-18	-	2120-0927	-	2120-0925	-	-	-	2120-0921	-	-	-	-
RZR 570 12-19	-	-	-	-	-	-	-	-	2120-0943	2120-0944	2120-0945	-
SPORTSMAN 570 14-18	2120-0928	2120-0927	-	2120-0925	-	2120-0923	-	2120-0921	-	-	-	-
SPORTSMAN 570 14-18	-	-	-	-	-	-	-	-	2120-0943	2120-0944	2120-0945	-
SPORTSMAN 600 03-05	2120-0928	2120-0927	2120-0926	-	-	-	-	-	-	-	-	-
SPORTSMAN 600 03-05	-	-	-	-	-	-	-	-	2120-0943	-	-	-
RANGER 700 05-09	-	-	-	-	2120-0924	-	-	2120-0921	-	-	-	-
RANGER 700 05-09	-	-	-	-	-	-	-	-	2120-0943	-	2120-0945	-
RANGER 700 06-09	-	-	2120-0926	-	-	-	-	-	-	-	-	-
RANGER 700 08-09	-	2120-0927	-	-	-	-	-	-	-	-	-	-
SPORTSMAN 700 (EFI ONLY) 04-08	-	-	-	-	2120-0924	-	-	2120-0921	-	-	-	-
SPORTSMAN 700 02-07	-	-	2120-0926	-	-	-	-	-	-	-	-	-
SPORTSMAN 700 02-07	-	-	-	-	-	-	-	-	2120-0943	-	-	-

PLOWES
WINCHES
UTV
RACKS
IMPLEMENTES & TOWING
LUGGAGE
BODY
CONTROLS
ELECTRICAL
WHEELS & TIRES
SUSPENSION & DRIVE
BRAKING
ENGINE
RIDER
GARAGE
PROMO

ELECTRICAL

FITS MODEL	LEFT HANDLEBAR CONTROLS PIGTAIL HARNESS	HEADLIGHT PIGTAIL HARNESS	TRANSMISSION SENSOR PIGTAIL HARNESS	FUEL INJECTOR PIGTAIL HARNESS	KEIHIN TPS SENSOR PIGTAIL HARNESS	MIKUNI THROTTLE SENSOR PIGTAIL HARNESS	IDLE AIR CONTROL VALVE PIGTAIL HARNESS	T-MAP SENSOR PIGTAIL HARNESS	POLARIS SPORTSMAN IGNITION KEYSWITCH PIGTAIL HARNESS	POLARIS RZR FUEL PUMP PIGTAIL HARNESS	POLARIS TEMP SENSOR PIGTAIL HARNESS	POLARIS RANGER PULSE BUSBAR PIGTAIL HARNESS
OEM REPLACEMENT PIGTAIL HARNESSES (CON'T)												
POLARIS (CON'T)												
SPORTSMAN 700 02-08	2120-0928	2120-0927	-	-	-	-	-	-	-	-	-	-
SPORTSMAN 700 EFI 04-08	-	-	-	-	-	-	-	-	-	-	2120-0945	-
RANGER 800 10-14	-	-	-	-	-	-	-	-	2120-0943	-	-	-
RANGER 800 05-14	-	-	-	-	-	-	-	2120-0921	-	-	-	-
RANGER 800 10	-	-	-	-	2120-0924	-	-	-	-	-	-	-
RANGER 800 10-11	-	-	2120-0926	-	-	-	-	-	-	-	-	-
RANGER 800 10-14	-	2120-0927	-	-	-	-	-	-	-	-	-	-
RANGER 800 10-16	-	-	-	-	-	-	-	-	-	2120-0944	2120-0945	-
RANGER 800 11-14	-	-	-	2120-0925	-	-	-	-	-	-	-	-
RANGER 800 11-16	-	-	-	-	-	2120-0923	2120-0922	-	-	-	-	-
RZR 800 08-10	-	2120-0927	-	-	2120-0924	-	-	-	-	-	-	-
RZR 800 08-14	-	-	-	-	-	-	-	2120-0921	-	-	-	-
RZR 800 08-14	-	-	-	-	-	-	-	-	2120-0943	2120-0944	2120-0945	-
RZR 800 11-14	-	-	-	2120-0925	-	2120-0923	2120-0922	-	-	-	-	-
SPORTSMAN 800 05-14	2120-0928	2120-0927	2120-0926	-	2120-0924	-	-	2120-0921	-	-	-	-
SPORTSMAN 800 05-14	-	-	-	-	-	-	-	-	2120-0943	-	2120-0945	-
SCRAMBLER 850 13-18	-	-	2120-0926	2120-0925	2120-0924	-	2120-0922	2120-0921	-	-	-	-
SCRAMBLER 850 13-18	-	-	-	-	-	-	-	-	2120-0943	2120-0944	2120-0945	-
SCRAMBLER 850 14-18	2120-0928	-	-	-	-	-	-	-	-	-	-	-
SPORTSMAN 850 09-11	-	-	-	-	-	2120-0923	-	-	-	-	-	-
SPORTSMAN 850 09-18	2120-0928	2120-0927	2120-0926	2120-0925	-	-	2120-0922	2120-0921	-	-	-	-
SPORTSMAN 850 09-19	-	-	-	-	-	-	-	-	2120-0943	2120-0944	2120-0945	-
SPORTSMAN 850 12-18	-	-	-	-	2120-0924	-	-	-	-	-	-	-
ACE 900 16	-	2120-0927	-	-	-	-	-	-	-	-	-	-
ACE 900 16-18	-	-	-	2120-0925	-	-	-	2120-0921	-	-	-	-
ACE 900 16-19	-	-	-	-	-	-	-	-	2120-0943	-	2120-0945	-
RANGER 900 DIESEL 11-14	-	-	2120-0926	-	-	-	-	-	-	-	-	-
RANGER 900 DIESEL 11-14	-	-	-	-	-	-	-	-	2120-0943	-	2120-0945	-
RANGER 900 XP (ALL MODELS) 13-18	-	-	-	2120-0925	-	-	-	2120-0921	-	-	-	-
RANGER 900 XP 13-19	-	-	-	-	-	-	-	-	2120-0943	2120-0944	2120-0945	-
RZR 900 (ALL MODELS) 11-14	-	-	-	-	-	-	2120-0922	-	-	-	-	-
RZR 900 (ALL MODELS) 15-18	-	-	-	-	-	-	-	2120-0921	-	-	-	-
RZR 900 11-18	-	-	-	2120-0925	-	-	-	-	-	-	-	-
RZR 900 11-19	-	-	-	-	-	-	-	-	2120-0943	2120-0944	2120-0945	-
BRUTUS HD 13-17	-	-	-	-	-	-	-	-	2120-0943	-	-	-
GENERAL 1000 16-19	-	-	-	-	-	-	-	-	2120-0943	-	2120-0945	-
GENERAL 1000 19	-	-	-	-	-	-	-	-	-	-	-	2120-0948
RANGER 1000 17-19	-	-	-	2120-0925	-	-	-	-	-	-	-	-
RANGER 1000 17-19	-	-	-	-	-	-	-	-	-	-	2120-0945	2120-0948
RANGER 1000 DIESEL 15-18	-	-	-	-	-	-	-	-	2120-0943	-	-	-
RANGER 1000 XP 17-18	-	-	-	-	-	-	-	-	2120-0943	2120-0944	-	-
RANGER ETX 15-16	-	-	-	-	-	-	-	-	2120-0943	2120-0944	2120-0945	-
RANGER ETX 325 15	-	-	-	-	-	2120-0923	-	-	-	-	-	-
RANGER ETX 325 15-16	-	2120-0927	-	-	-	-	-	-	-	-	-	-
RANGER EV 16-18	-	-	-	-	-	-	-	-	2120-0943	-	-	-
RANGER EV 325 10-14	-	2120-0927	-	-	-	-	-	-	-	-	-	-
RS1 18-19	-	-	-	-	-	-	-	-	-	-	-	2120-0948
RZR 1000 (ALL MODELS) 14-18	-	-	-	-	-	-	-	2120-0921	-	-	-	-
RZR 1000 14-16	-	-	-	-	-	-	-	-	2120-0943	-	-	-
RZR 1000 14-19	-	-	-	-	-	-	-	-	-	2120-0944	2120-0945	-
RZR TURBO	-	-	-	-	-	-	-	-	-	-	-	-
(ONLY FITS AIR INTAKE DUCT T-MAP) 16-18	-	-	-	-	-	-	-	2120-0921	-	-	-	-
RZR TURBO 16-19	-	-	-	-	-	-	-	-	2120-0943	2120-0944	2120-0945	-
SCRAMBLER 1000 14-18	2120-0928	-	2120-0926	2120-0925	2120-0924	-	2120-0922	2120-0921	-	-	-	-
SCRAMBLER 1000 14-18	-	-	-	-	-	-	-	-	2120-0943	2120-0944	2120-0945	-
SPORTSMAN 1000 15-18	2120-0928	2120-0927	2120-0926	2120-0925	2120-0924	-	2120-0922	-	-	-	-	-
SPORTSMAN 1000 15-19	-	-	-	-	-	-	-	-	2120-0943	2120-0944	2120-0945	-



COILS

Lighting, pulser/source and trigger coils are high-quality OEM replacements. Hot shot ignition coils produce an enhanced spark for a cleaner, more complete burn, resulting in the potential for more power. All coils feature high-quality components for superior performance and long life.

FITS MODEL	EXCITER COIL	PULSER COIL
COILS		
POLARIS (CON'T)		
2X4 93	2102-0245	-
250 4X4 93	2102-0245	-
250 6X6 93	2102-0245	-
BIG BOSS 250 4X6 89-92	2102-0245	-
BIG BOSS 250 6X6 91-92	2102-0245	-
TRAIL BLAZER 250 91-06	2102-0245	-
TRAIL BOSS 250	-	-
2X4/4X4 89-92	2102-0245	-
TRAIL BOSS 250ES 88	2102-0245	-
TRAIL BOSS 250R 88	2102-0245	-
XPLORER 250 00-02	2102-0245	-
300 2X4 94-95	2102-0245	-
300 4X4 94-95	2102-0245	-
300 6X6 94	2102-0245	-
TRAIL BOSS 300 2X4/4X4 95	2102-0245	-

FITS MODEL	EXCITER COIL	PULSER COIL
COILS (CON'T)		
POLARIS (CON'T)		
XPLORER 300 4X4 96-02	2102-0245	-
XPRESS 300 1996-1999	2102-0245	-
350L 2X4/4X4 93-94	2102-0245	-
350L 6X6 93-94	2102-0245	-
TRAIL BOSS 350L	-	-
2X4/4X4 90-92	2102-0245	-
YAMAHA		
YFM200 MOTO 4 86-89	-	2102-0194
YTM200E TRI-MOTO	-	-
SHAFT DRIVE 83-84	-	2102-0194
YTM200ER	-	-
YAMAHUALER 85-87	-	2102-0194
YTM225DR TRI-MOTO 85-86	-	2102-0194
YTM225DX TRI-MOTO 83-85	-	2102-0194



IGNITION SWITCHES

Exact OEM replacements. Includes mounting nut and two keys. Available for most 1996-current Polaris models. Replaces lost keys or broken switches.

FITS MODEL	PART #
IGNITION SWITCHES	
POLARIS	
TRAIL BLAZER 250 96-98	2106-0425
TRAIL BOSS 250 96-99	2106-0425
TRAIL BLAZER 250 99	2106-0426
TRAIL BLAZER 250 00-01	2106-0427
TRAIL BOSS 250 00-01	2106-0427
TRAIL BLAZER 250 02-06	2106-0428
XPLORER 300 96-99	2106-0425
XPRESS 300 96-99	2106-0425
HAWKEYE 300 (ALL) 04-15	2106-0428
SPORTSMAN 300 08-10	2106-0428
MAGNUM 325 00-01	2106-0427
XPEDITION 325 00	2106-0427
MAGNUM 325 02	2106-0428
SPORTSMAN ETX 15	2106-0428
TRAIL BOSS 325 02	2106-0428
XPEDITION 325 01-02	2106-0428
ACE 325 16	2106-0429
RANGER ETX 15-16	2106-0429
RANGER EV 16-18	2106-0429
ATP 330 04-05	2106-0428
MAGNUM 330 03-06	2106-0428
TRAIL BLAZER 330 08-13	2106-0428
TRAIL BOSS 330 03-07	2106-0428
SPORTSMAN 335 99-00	2106-0425
WORKER 335 99	2106-0425
SPORTSMAN 335 00	2106-0427
SCRAMBLER 400 96-99	2106-0425
SPORT 400 96-98	2106-0425
SPORTSMAN 400L 96	2106-0425
XPLORER 400 96-98	2106-0425
XPRESS 400 96-97	2106-0425
BIG BOSS 400L 97	2106-0426
SCRAMBLER 400 99	2106-0426
SPORT 400 99	2106-0426
SPORTSMAN 400L 96-97	2106-0426
XPLORER 400 99	2106-0426
SCRAMBLER 400 00-01	2106-0427
SPORTSMAN 400 01	2106-0427
XPLORER 400 00-01	2106-0427
SCRAMBLER 400 02	2106-0428
SPORTSMAN 400 02-05	2106-0428
SPORTSMAN 400 HO 08-14	2106-0428
TRAIL BLAZER 400 03	2106-0428
XPLORER 400 02	2106-0428
RANGER 400 10-14	2106-0429
MAGNUM 425 96	2106-0425

FITS MODEL	PART #
IGNITION SWITCHES (CON'T)	
POLARIS (CON'T)	
MAGNUM 425 97-98	2106-0426
XPEDITION 425 00	2106-0427
XPEDITION 425 01-02	2106-0428
OUTLAW 450 08	2106-0427
SPORTSMAN 450 06-07	2106-0428
SPORTSMAN 450 HO 16-18	2106-0428
DIESEL 455 99	2106-0426
DIESEL 455 00-01	2106-0427
SCRAMBLER 500 97-98	2106-0425
SPORTSMAN 500 96-98	2106-0425
XPLORER 500 97	2106-0425
BIG BOSS 500 98-99	2106-0426
MAGNUM 500 99	2106-0426
SCRAMBLER 500 99	2106-0426
SPORTSMAN 500 99	2106-0426
WORKER 500 99	2106-0426
PREDATOR 500 03-07	2106-0427
MAGNUM 500 00-01	2106-0427
OUTLAW 500 06-07	2106-0427
SCRAMBLER 500 00-01	2106-0427
SPORTSMAN 500 00-01	2106-0427
WORKER 500 01	2106-0427
ATP 500 04-05	2106-0428
MAGNUM 500 02-03	2106-0428
RANGER 500 SERIES 10	2106-0428
RANGER 500 SERIES 11	2106-0428
RANGER 500 04-10	2106-0428
SCRAMBLER 500 02-12	2106-0428
SPORTSMAN 500 02-13	2106-0428
RANGER 500 11-13	2106-0429
OUTLAW 525 07-08	2106-0427
SPORTSMAN 550 XP 09-14	2106-0428
RANGER 570 (FULLSIZE ONLY) 15-16	2106-0428
RZR 570 (ONLY MODELS WITH 3 POSITION KEYSWITCH) 13-17	2106-0428
SPORTSMAN 570 14-18	2106-0428
ACE 570 16-18	2106-0429
RANGER 570 MIDSIZE 14-18	2106-0429
RANGER 570 FULLSIZE 16-18	2106-0429
RZR 570 (ONLY MODELS WITH 4 POSITION KEYSWITCH) 12-18	2106-0429
SPORTSMAN 600 03-05	2106-0428
RANGER 700 05-09	2106-0428
RANGER TM 04-06	2106-0428
SPORTSMAN 700 02-07	2106-0428
RANGER 800 (EXCEPT 13-14 RANGER 800 MIDSIZE) 10-14	2106-0428
RZR 800 08-14	2106-0428
SPORTSMAN 800 05-14	2106-0428
RANGER 800 MIDSIZE 13-14	2106-0429
SCRAMBLER 850 13-18	2106-0428
SPORTSMAN 850 09-17	2106-0428
BRUTUS 900 HD 13-17	2106-0428
RANGER 900 XP 13-18	2106-0428
RANGER 900 DIESEL 11-14	2106-0428
RZR 900 11-16	2106-0428
ACE 900 16-18	2106-0429
GENERAL 1000 16-18	2106-0428
RANGER 1000 XP 17-18	2106-0428
RANGER 1000 DIESEL 15-18	2106-0428
RZR 1000 14-16	2106-0428
RZR 1000 TURBO 16	2106-0428
SCRAMBLER 1000 14-18	2106-0428
SPORTSMAN 1000 15-17	2106-0428



AGM MAINTENANCE-FREE BATTERY

A heavy-duty maintenance-free 12-volt battery offering the quality you expect from Moose at affordable prices. Superior vibration resistance and durability provide a long service life. Holds a charge three times longer than conventional batteries. Absorbed glass mat battery eliminates water loss; permitting the battery to be permanently sealed once it is filled with acid. Acid pack is included.

PART #	EQUIVALENT YUASA PART #
2113-0468	YTX4L-BS
2113-0469	YTX5L-BS
2113-0470	YTX7A-BS
2113-0483	YTZ7S
2113-0481	Y7B-BS
2113-0472	YTX9-BS
2113-0482	Y79B-BS
2113-0484	YTZ10S
2113-0473	YTX12-BS
2113-0475	YTX14AH-BS
2113-0476	YTX14HL-BS
2113-0474	YTX14-BS
2113-0477	YTX20HL-BS
2113-0479	YTX24HL-BS
2113-0478	YTX20CH-BS
2113-0480	YTX30L-BS

FITS MODEL	PART#
AGM MAINTENANCE FREE BATTERIES	
AEON (BENZAI)	
Cobra/CX-Sport 50/90/100 (all)	2113-0468
ARCTIC CAT	
50 DVX 06-10 (ALL)	2113-0469
90 06 (ALL EXCEPT DVX)	2113-0468
90, 90 UTILITY 16-17	2113-0469
90 DVX 06-17	2113-0469
150 00-13	2113-0472
150 16-17	2113-0472
250/300 (ALL EXCEPT DVX)	2113-0476
250 DVX 2X4 06	2113-0473
300 DVX 09-14	2113-0473
366/400/500 (ALL EXCEPT DVX)	2113-0475
400 DVX (ALL)	2113-0472
TRV400, CORE 10-13	2113-0475
400 ALTERRA, TRV, CORE 17	2113-0475
500 (ALL MODELS) 09	2113-0475
500 PROWLER 17	2113-0477
550 PROWLER 10-16	2113-0479
650 4X4 AUTOMATIC 04-06	2113-0475
650 PROWLER 06-10	2113-0479
650HI/TBX650/MUDPRO 05-12	2113-0475
700 PROWLER 09	2113-0479
700 PROWLER 10-17	2113-0480

FITS MODEL	PART#
AGM MAINTENANCE FREE BATTERIES	
ARCTIC CAT (CONT)	
TRV700 06-08	2113-0475
700 HDX 11-17	2113-0480
700 WILDCAT SPORT, TRAIL 16-17	2113-0480
1000 PROWLER 10-17	2113-0480
WILDCAT 1000/X/4/LTD 16-17	2113-0480
CAN AM	
DS50 QUEST 02-06	2113-0468
DS70 00-13	2113-0468
DS70 15-17	2113-0468
DS90/90F QUEST 02-17	2113-0468
200 RALLY 02-06	2113-0475
DS250 06-17	2113-0473
400 OUTLANDER XT, MAX 04-15	2113-0477
DS450 09-13	2113-0481
DS450 15	2113-0481
450 OUTLANDER 16-17	2113-0477
500 OUTLANDER/MAX/RENEGADE 15	2113-0477
570 OUTLANDER/RENEGADE 16-17	2113-0477
650 QUEST (OPT) 02-05	2113-0479
OUTLANDER, MAX, RENEGADE 09-13	2113-0477
650 OUTLANDER/OUTLANDER 6X6 16-17	2113-0477
660 OUTLANDER EFI 06	2113-0477
800 DEFENDER 16-17	2113-0477
800 OUTLANDER EFI RENEGADE 06-15	2113-0477
COMMANDER 800/1000 11-17	2113-0477
1000 DEFENDER 16-17	2113-0477
1000 OUTLANDER/RENEGADE/6X6 12-17	2113-0477
CANNONDALE	
BLAZE/CANNIBAL/FX400/MOTO 440/SPEED 02-03	2113-0472
FX400 01	2113-0472
CF-MOTO	
CF500-5 (X5) TERRALANDER 12-14	2113-0477
CF500-2 TERRALANDER 13	2113-0477
CF500-3 RANCHER (SSV) 10-12	2113-0480
CF600-5 (U6) RANCHER 12	2113-0480
CF625 B/C (X6) TERRALANDER 11-13	2113-0480
CF625-3 (Z6) TERRACROSS (SSV) 11-13	2113-0480
CF800 (Z8) ZFORCE 13-14	2113-0480
CF800-2 (X8) TERRALANDER 12-13	2113-0480
CF800-3 (U8) UFORCE/TRACKER (SSV/UTV) 13-14	2113-0480
ETON	
50/90 AXL/NXL/RXL/TXL 99-03	2113-0468
50/90 04-05 (ALL)	2113-0469
70 VIPER 11-13	2113-0469
DXL90 SIERRA 99-03	2113-0468
CXL150 YUKON II 00-11	2113-0472
YXL150 YUKON 00-03	2113-0472
150R VIPER 00-13	2113-0472
250 VECTOR 00-13	2113-0473
GOES	
X QUAD 450	2113-0472
520 MAX	2113-0474
HONDA	
TRX90X/EX 06-17	2113-0469
ATC125M 86-87	2113-0473
TRX125 FOURTRAX 87-88	2113-0472
ATC200ES BIG RED 82-84	2113-0475
ATC200M 84-85	2113-0475
TRX200 FOURTRAX 84	2113-0475
TRX200 FOURTRAX 90-96	2113-0473
TRX200SX FOURTRAX 86-88	2113-0473
ATC250ES BIG RED 85-87	2113-0473
ATC250SX 85-87	2113-0473
TRX250 FOURTRAX 85-87	2113-0473
TRX250 FOURTRAX RECON 97-17	2113-0473
TRX250 RECON/ES 97-03	2113-0473
TRX250TE/TM 97-17	2113-0473
TRX250X/EX 01-17	2113-0472

FITS MODEL	PART#
AGM MAINTENANCE FREE BATTERIES	
HONDA (CONT)	
TRX300 FOURTRAX 88-00	2113-0474
TRX300X/EX 93-12	2113-0472
TRX300FV FOURTRAX 4X4 88-00	2113-0474
FL350R ODYSSEY 85	2113-0473
TRX350 FOURTRAX 4X4 86-89	2113-0474
TRX350 RANCHER 00-06	2113-0474
TRX350D FOREMAN 4X4 87-89	2113-0474
FL400R PILOT 89-90	2113-0474
TRX400 RANCHER AT 04-06	2113-0474
TRX400X/EX FOURTRAX/SPORTRAX 99-13	2113-0472
TRX400FV FOREMAN 95-03	2113-0474
TRX420 FOURTRAX RANCHER 4X4 09-13	2113-0474
TRX450ER 06-13	2113-0483
TRX450 FOURTRAX FOREMAN S/ES 98-04	2113-0474
TRX500 FE/FM/TM FOURTRAX FOREMAN/ES 4X4 05-11 (ALL)	2113-0474
TRX500FA FOURTRAX RUBICON 01-11	2113-0474
TRX650 FOURTRAX RINCON STD. 03-05	2113-0474
TRX680FA FOURTRAX RINCON 06-17 (ALL)	2113-0477
MUV700 BIG RED 08-13	2113-0474
TRX700XX 08-13	2113-0472
PIONEER 700 15-16	2113-0474
HYOSUNG	
TE450S 00-11	2113-0472
KASEA	
Mini Skyhawk 50 (all)	2113-0468
Skyhawk 50/90 (all)	2113-0469
KS/KU (all)	2113-0470
Skyhawk 150/170/250 (all)	2113-0470
Adventure Buggy 125/150 (all)	2113-0470
KAWASAKI	
KFX50 07-17	2113-0469
KFX80 03-05	2113-0469
KFX90 07-17	2113-0469
KLF220A Bayou (Canada) 92-02	2113-0475
KLF250A Bayou (Canada) 03-05	2113-0475
KAF300A Mule 500/520/550 (all)	2113-0475
KEF300A Lakota 95-00	2113-0475
KEF300A/B Lakota Sport 01-03	2113-0475
KLF300B Bayou 88-04	2113-0475
KLF300C Bayou 4x4 89-04	2113-0475
KVF300A/B Prairie 4x4 99-02	2113-0475
KVF300 Brute Force 13-17	2113-0473
KVF360 Prairie 13	2113-0475
KAF400 Mule 600/610 05-16	2113-0475
KFX400 03-06	2113-0472
KVF400A Prairie 4x4 97-00	2113-0475
KVF400B/C Prairie 4x4 98-02	2113-0475
KVF400D Prairie 4x4 99-02	2113-0475
KAF620 Mule 3000/3010/3020 03-05	2113-0477
KAF620 Mule 3010 4x4 Advantage Classic 03-07	2113-0477
KTM	
450SX/XC 08-11	2113-0469
505SX 08-11/XC 08-10	2113-0469
525XC 10-11	2113-0469
KYMCO	
50/90 Mongoose (all)	2113-0469
MXU150 (all)	2113-0472
KXR / Mongoose / MXU 250 (all)	2113-0473
Maxxer 300	2113-0473
KXR / Mongoose / MXU300SD (all)	2113-0473
MAXXER 450i	2113-0477
MXU 450i	2113-0477
MXU 500i	2113-0477
UXV500i 4x4	2113-0477
MXU 700i	2113-0477
Maxxer 450 16-17	2113-0477
UXV450 16	2113-0477

FITS MODEL	PART#
AGM MAINTENANCE FREE BATTERIES	
KYMCO (CONT)	
MXU500 14-17	2113-0477
UXV500 16	2113-0477
MXU700 16-17	2113-0477
UXV700 16	2113-0477
POLARIS	
50 Predator/Outlaw 04-16	2113-0469
50 Scrambler 01-02	2113-0468
50 Scrambler 03	2113-0469
90 Scrambler/Sportsman 01-02	2113-0468
90 Predator/Sportsman/Outlaw 03-14	2113-0469
110 Outlaw 17	2113-0469
110 Sportsman 17	2113-0469
170 Ranger RZR 11-14	2113-0473
170 RZR 16-17	2113-0473
200 Phoenix/Sawtooth 05-17	2113-0473
250 85-05 (all)	2113-0475
325 87-02 (all)	2113-0475
330 Magnum/Trail Boss 03-12	2113-0475
335 Sportsman 98-01	2113-0475
400 94-14 (all)	2113-0475
400 Sportsman 09-11	2113-0475
425 95-02 (all except Ranger)	2113-0475
425 Ranger 2x4 02-03	2113-0480
450 Diesel (primary) 99-03	2113-0480
450 Diesel (secondary) 99-03	2113-0475
450 Outlaw 07-10	2113-0472
500 99-12 (all except Predator/Ranger/ Sportsman EFI/Outlaw)	2113-0475
500 Predator/Outlaw 03-06	2113-0472
500 Sportsman H.O. 96-12	2113-0475
500 Sportsman EFI 06-10	2113-0480
500 Ranger 6x6/4x4 98-04	2113-0480
500 Ranger 4x4 04-11	2113-0480
525 Outlaw 08-12	2113-0472
550 Sportsman 09-10	2113-0477
550 Sportsman EPS/XP 10-12	2113-0475
550 Sportsman X2 10-14	2113-0477
570 Sportsman 14-17	2113-0475
570 RZR 12-17	2113-0475
600 Sportsman 04-05	2113-0480
700 Ranger 6x6 06-10	2113-0480
700 Sportsman, Military 02-08	2113-0480
700 Sportsman 09-10	2113-0480
800 Ranger 10-14	2113-0480
800 Ranger RZR 08-14	2113-0477
800 Ranger RZR 4 10-14	2113-0480
800 Sportsman 4x4 11-13	2113-0477
800 Sportsman 6x6 05-13	2113-0480
800 Sportsman 14	2113-0477
800 Sportsman 6x6 14	2113-0480
850 Sportsman 09	2113-0480
850 Sportsman 10-17	2113-0477
850 Scrambler 14	2113-0477
900 RZR 11-17	2113-0480
1000 Scrambler 14-17	2113-0477
QIANJIANG	
ATV50/100 (all)	2113-0468
SUZUKI	
LT-Z50 Quad Sport 06-11	2113-0469
LT80 Quad Sport 87-06	2113-0469
LT-Z90 Quad Sport 07-11	2113-0470
LT230E Quad Runner 88-93	2113-0473
LT-F250 Quad Runner 88-01	2113-0475
LT-F250F Quad Runner 99-02	2113-0475
LT-F250/F Ozark 02-16	2113-0473
LT-Z250 Quad Sport 04-11	2113-0472
LT-4WD 250 87-99	2113-0475
LT-F4WDX King Quad 91-99	2113-0475

FITS MODEL	PART#
AGM MAINTENANCE FREE BATTERIES	
SUZUKI (CONT)	
LT-F4WDX King Quad 99-02	2113-0475
LT300E Quad Runner 300E 87-89	2113-0475
LT-F300F King Quad 99-02	2113-0475
LT400 Eiger 02-07 (all)	2113-0474
LT-Z400 Quad Sport 03-16	2113-0472
LT-A400 King Quad 09-17	2113-0474
LT-A450 King Quad 07-11	2113-0474
LT-R450 Quad Racer 06-11	2113-0470
LT-A500 King Quad 00-14	2113-0478
LT-A500F/LT-F500F Vinson/Manual 4WD 02-03	2113-0478
LT-A500F/LT-F500F Vinson/Manual 4WD 04-07	2113-0478
QUV620F 05	2113-0477
LT-A700X King Quad 05-07	2113-0478
LT-A750X King Quad 07-17	2113-0478
TGB	
Blade 250 Quad / Congo ATV	2113-0474
Blade 325 Quad	2113-0474
Avenger 400 LE Quad	2113-0477
Avenger 500 R Quad	2113-0477
Blade 525 SE/SL 4X4	2113-0477
YAMAHA	
YFZ50 17	2113-0483
YFM90R Raptor 09-17	2113-0469
YFM125R/Raptor 11-13	2113-0483
YFM200 Moto 4 85	2113-0475
YFM200DX Moto 4 86-89	2113-0475
YTM200E TriMoto 83-84	2113-0475
YTM200ER TriMoto 85	2113-0475
YFM225 Moto 4 86-88	2113-0475
YTM225DR/DX TriMoto 83-86	2113-0475
YFU-1/1T Pro Hauler 89	2113-0475
YFM250 Moto 4 89-91	2113-0475
YFM250 Bear Tracker 99-04	2113-0475
YFM250B Big Bear 07-10	2113-0475
YFM250R Raptor 08-13	2113-0483
YFM250B Bruin 05-06	2113-0475
YFM300 Grizzly 11-13	2113-0473
YFM350ER Moto 4 87-95	2113-0475
YFM350FW Big Bear 87-99	2113-0475
YFM350FX Wolverine 06-10	2113-0475
YFM350G/FG Grizzly 07-14	2113-0475
YFM350R Raptor 04-13	2113-0484
YFM350U Big Bear 87-99	2113-0475
YFP350 Terra Pro 88	2113-0475
YFM350B Bruin 04-06	2113-0475
YFM400FB Big Bear 00-12	2113-0477
YFM400FG Grizzly 07-08	2113-0475
YFM400FW Kodiak 93-95	2113-0475
YFM400FW Kodiak Automatic 96-02	2113-0477
YFM400FW Kodiak Automatic 03-06	2113-0475
YFM400FW/N Big Bear 00-03	2113-0477
YFM450FG Grizzly 07-14	2113-0475
YFM450FX Wolverine 03-10	2113-0477
YFZ450 04-09	2113-0481
YFZ450R/X 09-17	2113-0483
YFM550 Grizzly 09-14	2113-0477
YFM600FW/YFV600 Grizzly 98-01	2113-0477
YFM660FA Grizzly 02-08	2113-0477
YFM660R Raptor 01-05	2113-0474
YFM700FG Grizzly 07-17	2113-0477
YFM700R Raptor 06-17	2113-0482
Kodiak EPS 16-17	2113-0477



TERMINAL TENDER BLOCK

Specifically designed to safely add up to six different accessories requiring 12-volt power onto your battery. Includes both positive and negative terminal blocks. Stacking ring terminals or loose wire ends on battery posts can cause harm to your accessories. Excellent for UTVs with added accessories like stereos, GPS, winch, heaters, etc. Fits any Powersports battery with square bolt-in posts, dry or wet cell. CNC machined from billet aluminum. Made in the U.S.A.

DESCRIPTION	PART #
TERMINAL TENDER BLOCK	2113-0720

PLOWS

WINCHES

UTV

RACKS

IMPLEMENT & TOWING

LUGGAGE

BODY

CONTROLS

ELECTRICAL

WHEELS & TIRES

SUSPENSION & DRIVE

BRAKING

ENGINE

RIDER

GARAGE

PROMO



NEW FITMENTS FOR T6B



STATORS

OEM style replacement stators. Designed to be complete bolt-on replacements with all connectors and grommets (unless otherwise noted). High output stators also available with additional electrical power.

FITS MODEL	PART #
STATORS	
ARCTIC CAT	
375 2X4 AUTOMATIC 02	2112-0676
375 4X4 AUTOMATIC 02	2112-0676
400 2X4 98-99	2112-0886
400 2X4 00	2112-0886
400 4X4 98-99	2112-0886
400 4X4 00	2112-0886
400 MANUAL 4X4 03	2112-0676
400 4X4 AUTOMATIC 03-04	2112-0676
400 2X4 MANUAL 01 (EARLY 01)	2112-0886
400 2X4 MANUAL 01 (LATE 01)	2112-0886
400 4X4 MANUAL 01 (EARLY 01)	2112-0886
400 4X4 MANUAL 01 (LATE 01)	2112-0886
400 4X4 MANUAL 03	2112-0676
400 AUTOMATIC 08	2112-0676
400ACT 4X4 AUTOMATIC 04	2112-0676
400ACT 4X4 MANUAL 04	2112-0676
400ACT MRP 4X4 AUTOMATIC/MANUAL 04	2112-0676
400FIS AUTOMATIC 05-07	2112-0676
400FIS LE AUTOMATIC 05-07	2112-0676
400FIS 2X4 AUTOMATIC 03-04	2112-0676
400FIS 4X4 AUTOMATIC 03-04	2112-0676
400FIS MANUAL 05-07	2112-0676
400FIS 2X4 MANUAL 02	2112-0886
400FIS 2X4 MANUAL 03-04	2112-0676
400FIS 4X4 MANUAL 02	2112-0886
400FIS 4X4 MANUAL 03-04	2112-0676
400FIS MRP 4X4 AUTOMATIC/MANUAL 04	2112-0676
400TBX 4X4 AUTOMATIC 04	2112-0676
400TBX 4X4 AUTOMATIC 05-06	2112-0676
400TRV 06-07	2112-0676
400VP 4X4 AUTOMATIC 05-06	2112-0676
400VP 4X4 MANUAL 05-06	2112-0676
454 2X4 BEARCAT 97-98	2112-0886
454 4X4 97-98	2112-0886 ¹
454 BEARCAT 4X4 96	2112-0886 ²
500 4X4 98-99	2112-0886
500 AUTO 08-09	2112-0885
500 AUTOMATIC 4X4 00-02	2112-0675
500 AUTO LE 08-09	2112-0885
500 4X4 MANUAL 00	2112-0886
500 4X4 MANUAL 01 (EARLY 01)	2112-0886
500 4X4 MANUAL 01 (LATE 01)	2112-0886
500 MANUAL 08-09	2112-0885
500FIS 4X4 AUTOMATIC 02	2112-0675
500FIS AUTOMATIC 03-07	2112-0885
500FIS MANUAL 02	2112-0886
500FIS MANUAL 03-07	2112-0885
500TBX 4X4 AUTOMATIC 02	2112-0675
500TBX 4X4 AUTOMATIC 03-05	2112-0885
500TBX 4X4 AUTOMATIC 06	2112-0676
500TRV 4X4 AUTOMATIC CAT 03-05	2112-0885
500 TRV CORE 13	2112-1153
500 TRV CORE INT. 13	2112-1153
500 TRV HI EFI 09-10	2112-1153
500 TRV HI EFI LE 09	2112-1153
500 TRV HI EFI INT. 10	2112-1153
500 XT UTILITY MODEL 13	2112-1153
550 CORE 13	2112-1153
550 CRUISER GT 12	2112-1153
550 CRUISER PS 11	2112-1153
550 CRUISER PS INT. 11	2112-1153
550 EFT 15	2112-1153
550 GT UTILITY MODEL 12	2112-1153
550 HI EFI 09-10	2112-1153
550 HI EFI INT. 10	2112-1153

FITS MODEL	PART #
STATORS (CONT)	
ARCTIC CAT (CONT)	
550 HI EFI LE 09	2112-1153
550 LTD UTILITY MODEL 11-12	2112-1153
550 LTD UTILITY MODEL INT. 11-12	2112-1153
550 PROWLER HI EFI 09	2112-1153
550 PROWLER XT 10-14	2112-1153
550 PROWLER XT INT. 10-12	2112-1153
550 PS 11	2112-1153
550 S EFI 10	2112-1153
550 TRV GT 11-12	2112-1153
550 TRV S EFI 10	2112-1153
550 TRV EFT 15	2112-1153
550 TRV XT 13	2112-1153
550 UTILITY MODEL 11-12	2112-1153
650 FIS V-TWIN AUTO 05-06	2112-0967
650 HI 08	2112-0965
650 HI 10-11	2112-0965
650 HI FIS 07-08	2112-0965
650 HI FIS LE 07	2112-0965
650 HI LE 05	2112-0965
650 HI SE 06	2112-0965
650 MRP AUTO 4X4 04	2112-0967
650 MUDPRO HI 10	2112-0965
650 PROWLER 07-08	2112-0965
650 PROWLER XT 06-09	2112-0965
650 TBX HI 07	2112-0965
650 TRV HI 07-09	2112-0965
650 AUTO 4X4 04	2112-0967
650 UTILITY MODEL 11	2112-0965
700 CRUISER 12	2112-1153
700 CRUISER HI 09	2112-1153
700 CRUISER PS 11	2112-1153
700 GT UTILITY MODEL 12	2112-1153
700 HI EFI 08-09	2112-1153
700 UTILITY MODEL 11-12	2112-1153
700 LTD UTILITY MODEL 11-12	2112-1153
700 UTILITY MODEL INT. 11-12	2112-1153
700 MUDPRO 11-12	2112-1153
700 MUDPRO HI EFI 09-10	2112-1153
700 MUDPRO LTD 12	2112-1153
700 PROWLER HDX 11-12	2112-1153
700 PROWLER HDX INT. 11-12	2112-1153
700 PROWLER XT HI EFI 09	2112-1153
700 PROWLER XT 08-12	2112-1153
700 PROWLER XT INT. 10-12	2112-1153
700 TBX GT 12	2112-1153
700 TBX HI EFI 10	2112-1153
700 TBX LTD 11	2112-1153
700 TRV 11	2112-1153
700 TRV INTL. 11	2112-1153
700 TRV EFI 08	2112-0968
700 TRV GT 11-12	2112-1153
700 TRV HI EFI 10	2112-1153
700 TRV HI EFI CRUISER 09-10	2112-1153
700 TRV S EFI 10	2112-1153
700 TRV S EFI INTL. 10	2112-1153
700 EFI 08	2112-0968
700 EFI HI LE 09	2112-1153
700 EFI HI SE 09	2112-1153
700 EFI FIS 07	2112-0968
700 EFI FIS LE 07	2112-0968
700 EFI LE 08	2112-0968
700 EFI SE 06	2112-0968
1000 CRUISER 12	2112-1153
1000 GT UTILITY MODEL 12	2112-1153
1000 LTD UTILITY MODEL 11	2112-1153
1000 MUDPRO 11	2112-1153
1000 MUDPRO H2 10	2112-1153
1000 MUDPRO LTD 12	2112-1153
1000 PROWLER XT 09-11, 13-14	2112-1153
1000 PROWLER XT INT. 10-11, 13	2112-1153
1000 THUNDERCAT AUTO SE 08	2112-1153
1000 THUNDERCAT H2 09	2112-1153
1000 THUNDERCAT H2 LE 10	2112-1153
1000 TRV EFT 14	2112-1153
1000 TRV GT 12	2112-1153
1000 TRV GT INT. 12	2112-1153
1000 TRV H2 EFI CRUISER 10	2112-1153
1000 TRV H2 EFI CRUISER INT. 10	2112-1153
1000 XT 13-14	2112-1153
1000 XT INT. 13	2112-1153

FITS MODEL	PART #
STATORS (CONT)	
CAN-AM	
OUTLANDER 400 MAX STD EFI 08-14	2112-0959 ³
OUTLANDER 400 MAX XT EFI 08-14	2112-0959 ³
OUTLANDER 400 STD EFI 08-14	2112-0959 ³
OUTLANDER 400 XT EFI 08-14	2112-0959 ³
OUTLANDER MAX 500 STD/XT 4X4 07-08	2112-0959
OUTLANDER 500 MAX STD EFI 09-14	2112-0959 ³
OUTLANDER 500 MAX XT EFI 09	2112-0959 ³
OUTLANDER 500 STD 07-08	2112-0959 ³
OUTLANDER 500 STD EFI 09-14	2112-0959 ³
OUTLANDER 500 XT 07-08	2112-0959 ³
OUTLANDER 500 XT EFI 09	2112-0959 ³
OUTLANDER 650 EFI XT 09	2112-0959
OUTLANDER 650 STD 4X4 06-08	2112-0959
OUTLANDER 650 STD EFI 06-14	2112-0959 ³
OUTLANDER 650 XT 4X4 06-08	2112-0959
OUTLANDER MAX 650 XT 4X4 06-08	2112-0959
OUTLANDER 650 MAX EFI XT 09	2112-0959
OUTLANDER 650 MAX STD EFI 09-14	2112-0959 ³
OUTLANDER 800 STD 4X4 06-08	2112-0959
OUTLANDER 800 XT 4X4 06-08	2112-0959
OUTLANDER MAX 800 LTD 4X4 07-08	2112-0959
OUTLANDER MAX 800 STD 4X4 06-08	2112-0959
OUTLANDER MAX 800 XT 4X4 06-08	2112-0959
OUTLANDER 800R MAX EFI 09-12	2112-0959 ³
OUTLANDER 800R MAX LTD EFI 09	2112-0959 ³
OUTLANDER 800R MAX XT EFI 09	2112-0959 ³
OUTLANDER 800R STD EFI 09-11	2112-0959 ³
OUTLANDER 800R XT EFI 09	2112-0959 ³
CF-MOTO	
CF450 EFI/EPS (ALL)	2112-1152
CF500 2/2A (ALL)	2112-1152
CF500 ALL MODELS (ALL)	2112-1152
X5 TERRALANDER (ALL)	2112-1152
CF520 EFI/EPS (ALL)	2112-1152
CF600 EFI (ALL)	2112-1152
Z6 TERRACROSS (ALL)	2112-1152
X6 TERRALANDER (ALL)	2112-1152
Z6-EX TERRACROSS (ALL)	2112-1152
CF800 TRACKER (ALL)	2112-1152
X8 TERRALANDER (ALL)	2112-1152
E-TON	
AXL50 LIGHTNING 00-01	2112-0483
RXL50 VIPER 02-04	2112-0483
TXL50 THUNDER (ALL)	2112-0483
RXL70 VIPER 2-STROKE 04-07	2112-0483
AXL90 LIGHTNING 2-STROKE (ALL)	2112-0483
DXL90 SIERRA 2-STROKE 00-05	2112-0483
RXL90 VIPER 2-STROKE 02-07	2112-0483
TXL90 THUNDER 2-STROKE 00-01	2112-0483
HONDA	
TRX90 SPORTRAX 93-05	2112-0982
TRX200 FOURTRAX 90-91	2112-0685 ⁴
TRX200D FOURTRAX 91-97	2112-0685 ⁴
ATC250ES 85-87	2112-0690 ⁵
ATC250R 85-86	2112-0490 ⁶
ATC250SX 85-87	2112-0690 ⁵
TRX250X 87-92	2112-0491 ⁶
TRX250 RECON 97-04	2112-0688 ⁸
TRX250 RECON ES 02-04	2112-0688 ⁸
TRX250 UTILITY MODEL 85-87	2112-0690 ⁷
TRX350 FOURTRAX 86-87	2112-0489
TRX350FE RANCHER ES 4X4 00-06	2112-0687
TRX350FM RANCHER S 4X4 00-06	2112-0687
TRX350TE RANCHER ES 00-06	2112-0687
TRX350TM RANCHER S 00-06	2112-0687
TRX680 FOURTRAX RINCON 06-16 (ALL)	2112-0969
KAWASAKI	
KLF220 BAYOU 96-02	2112-0498
KLF250 BAYOU 03-11	2112-0498
KEF300A LAKOTA 95-00	2112-0482
KEF300B LAKOTA SPORT 01-03	2112-0482
KLF300A BAYOU 86-87	2112-0887 ⁹
KLF300B BAYOU 88-91	2112-0482
KLF300C BAYOU 92-04	2112-0482 ¹⁰
KLF300C BAYOU 89-91	2112-0482
KLF300C BAYOU 92-04	2112-0482 ¹⁰
KVF360 PRAIRIE 2X4/4X4 03-12	2112-0692
KVF650 BRUTE FORCE 4X4 05-11	2112-0496
KVF650 PRAIRIE 02-03	2112-0496
KVF650I BRUTE FORCE 4X4 06	2112-0497

FITS MODEL	PART #
STATORS (CON'T)	
KAWASAKI (CON'T)	
KVF650I BRUTE FORCE 4X4I 07-11	2112-0497
KFX700 04-09	2112-0493 ⁶
KVF700 PRAIRIE 4X4 04-06	2112-0496
KVF750I BRUTE FORCE 4X4I 05-07	2112-0497
KVF750I BRUTE FORCE 4X4I 08-11	2112-1145
KVF750I BRUTE FORCE 4X4I 12-14	2112-1155
KRT750 TERYX4 (ALL) 12-13	2112-1155
POLARIS	
SPORTSMAN 90 01-06	2112-0483
PHOENIX 200 05-13	2112-1154
SAWTOOTH 200 06-07	2112-1154
MAGNUM 325 2X4 00-02	2112-0682 ¹¹
MAGNUM 325 4X4 00-02	2112-0682 ¹¹
TRAIL BOSS 325 00-02	2112-0682 ¹¹
XPEDITION 325 01-02	2112-0682 ¹¹
ATP 330 4X4 04-05	2112-0683 ¹²
MAGNUM 330 2X4 03-05	2112-0683 ¹²
MAGNUM 330 HDS 03	2112-0683 ¹²
MAGNUM 330 4X4 03-06	2112-0683 ¹²
TRAIL BOSS 330 03-09	2112-0683 ¹²
TRAIL BLAZER 330 08-09	2112-0683 ¹²
SPORTSMAN 335 99-00	2112-0486
WORKER 335 99	2112-0486
400L 2X4 94	2112-0487
400L 4X4 94	2112-0487
400L 6X6 94	2112-0487
400L SPORT 2X4 95	2112-0487
400L SPORT 4X4 95	2112-0487
BIG BOSS 400L 6X6 95-97	2112-0487
RANGER 400 4X4 10-12	2112-0680 ¹³
SPORTSMAN 400 94-97	2112-0487
SPORTSMAN 400 01-02	2112-0486
SPORTSMAN 400 03	2112-0488
SPORTSMAN 400 04 (EARLY 04)	2112-0488
SPORTSMAN 400 04-05	2112-0680 ¹⁴
SPORTSMAN 400 HD 4X4 08-10	2112-0680
XPLORER 400 98-02	2112-0487
XPLORER 400 4X4 95	2112-0487
XPLORER 400L 96-97	2112-0487
XPRESS 400L 96	2112-0487
XPRESS 400L 97	2112-0487
MAGNUM 425 2X4 95-98	2112-0486
MAGNUM 425 4X4 95	2112-0486
MAGNUM 425 4X4 96-97	2112-0486
MAGNUM 425 4X4 98-99	2112-0486
MAGNUM 425 6X6 96-98	2112-0486
SPORTSMAN 450 HD 06-07	2112-0680 ¹⁵
RANGER 425 2X4 04	2112-1101
BIG BOSS 500 6X6 98-99	2112-0484 ¹⁶
BIG BOSS 500 6X6 02 (EARLY 02)	2112-0485 ¹⁷
BIG BOSS 500 6X6 02 (LATE 02)	2112-0488 ¹⁸
MAGNUM 500 4X4 99	2112-0484 ¹⁶
MAGNUM 500 4X4 00 (EARLY 00)	2112-0484 ¹⁶
MAGNUM 500 4X4 00 (LATE 00)	2112-0485 ¹⁷
MAGNUM 500 4X4 01	2112-0485 ¹⁷
MAGNUM 500 4X4 02 (EARLY 02)	2112-0485 ¹⁷
MAGNUM 500 4X4 02 (LATE 02)	2112-0488 ¹⁸
RANGER 500 02 4X4	2112-0681 ²⁰
RANGER 500 4X4 03	2112-0488
RANGER 500 4X4 EFI 06-10	2112-0677 ²¹
RANGER 500 6X6 03	2112-0485 ¹⁷
RANGER 500 4X4 05	2112-1101
RANGER 500 6X6 04	2112-1101
SPORTSMAN 500 4X4 96-97	2112-0486
SPORTSMAN 500 4X4 98-99	2112-0484 ¹⁶
SPORTSMAN 500 4X4 00 (EARLY 00)	2112-0485 ¹⁷
SPORTSMAN 500 4X4 00 (LATE 00)	2112-0485 ¹⁷
SPORTSMAN 500 4X4 01	2112-0485 ¹⁷
SPORTSMAN 500 4X4 02 (EARLY 02)	2112-0485 ¹⁷
SPORTSMAN 500 4X4 02 (LATE 02)	2112-0488 ¹⁸
SPORTSMAN 500 4X4 03	2112-0488 ¹⁸
SPORTSMAN 500 05-06, 08-10 (NON EFI)	2112-0680 ¹⁵
SPORTSMAN 500 6X6 02 (EARLY 02)	2112-0485 ¹⁷
SPORTSMAN 500 6X6 02 (LATE 02)	2112-0488 ¹⁸
SPORTSMAN 500 6X6 03	2112-0488 ¹⁸
SPORTSMAN 500 6X6 04	2112-0680 ¹⁵
SPORTSMAN 500 6X6 05, 07-08	2112-0680 ¹⁵
SPORTSMAN 500 6X6 99 ONLY	2112-0484 ¹⁶
SPORTSMAN 500 EFI 06-09	2112-0677 ²¹

FITS MODEL	PART #
STATORS (CON'T)	
POLARIS (CON'T)	
SPORTSMAN X2 500 EFI 06-09	2112-0677 ²¹
SPORTSMAN TOURING 500 EFI 08-09	2112-0677 ²¹
WORKER 500 01	2112-0485 ¹⁷
WORKER 500 02 (EARLY 02)	2112-0485 ¹⁷
WORKER 500 02 (LATE 02)	2112-0488
XPLORER 500 97	2112-0486
SPORTSMAN 600 03	2112-0681 ²⁰
SPORTSMAN 600 04	2112-0678 ²⁴
SPORTSMAN 600 04	2112-0681 ²⁵
SPORTSMAN 600 04	2112-0679 ²⁶
SPORTSMAN 700 02-EARLY 03 AND EARLY 04	2112-0681 ²⁷
SPORTSMAN 700 04	2112-0678 ²⁶
SPORTSMAN 700(NON EFI) 05-06	2112-0678
SPORTSMAN 700 EFI 05-06	2112-0679 ²⁸
SPORTSMAN 700 EFI 4X4 07	2112-0960
SPORTSMAN 700 X2 EFI 08	2112-0773
RANGER 700 EFI 4X4/6X6 08-09	2112-0773
RANGER 800 EFI 4X4/6X6 10-11	2112-0773
RZR 800 EFI 09-11	2112-0773
RZR 800 EFI "S" MODEL 09-11	2112-0773
SPORTSMAN 800 EFI X2 07	2112-0960
SPORTSMAN 800 EFI 05-06	2112-0679
SPORTSMAN 800 EFI 4X4 07	2112-0960
SPORTSMAN 800 EFI 08-11	2112-0773
SPORTSMAN 800 EFI 6X6 09-11	2112-0773
SUZUKI	
LTF250 OZARK 02-09/12-14	2112-1211
LT-A400 EIGER 2WD 02-07	2112-0696
LT-A400F EIGER 4WD 02-07	2112-0696
LT4400F KINGQUAD 08-09	2112-1119
LT4500F QUADMASTER 00	2112-0502
LT4500F QUADMASTER 01	2112-0502
LTF500F QUADRUNNER 98-99	2112-0502
LTF500F QUADRUNNER 00	2112-0502
LTF500F QUADRUNNER 01	2112-0502
LTF500F QUADRUNNER 02	2112-0501
LT4700X KING QUAD 4X4 06-07	2112-0698
LT-V700F TWIN PEAKS 04-05	2112-0496
LT4750X KING QUAD 08-09	2112-0698
LT4750X KING QUAD 11	2112-0698
TGB	
250 BLADE (ALL)	2112-1249
325 BLADE (ALL)	2112-1249
325 TARGET (ALL)	2112-1249
425 BLADE (ALL)	2112-1250
450 BLADE (ALL)	2112-1250
550 BLADE SE (ALL)	2112-1250
550 TARGET (ALL)	2112-1250
YAMAHA	
YFM225 MOTO 4 86-88	2112-0506
YFB250F TIMBERWOLF 92-93	2112-0889
YFB250F TIMBERWOLF 94-96	2112-0514
YFB250F TIMBERWOLF 97-00	2112-0514
YFM250 89-91	2112-0506
YFM250 BEAR TRACKER 99-00	2112-0514
YFM250 BEAR TRACKER 01-03	2112-0509
YFM250X BEAR TRACKER 04	2112-0509
YFM350 BIG BEAR 87	2112-0511
YFM350 BIG BEAR 88-89	2112-0504
YFM350 BIG BEAR 90-94	2112-0508
YFM350 BIG BEAR 2WD 98	2112-0513
YFM350 BIG BEAR 2X4 97	2112-0513
YFM350 MOTO 4 88-89	2112-0504
YFM350 MOTO 4 90-94	2112-0508
YFM350 WARRIOR 87	2112-0511
YFM350 WARRIOR 88-89	2112-0504
YFM350 WARRIOR 90-95	2112-0508
YFM350 WARRIOR 96-01	2112-0513
YFM350 WARRIOR 02-03	2112-0518
YFM350 WOLVERINE 95-99	2112-0517
YFM350 WOLVERINE 00-01	2112-0515
YFM350 WOLVERINE 02-05	2112-0505
YFM350FW BIG BEAR 4X4 96	2112-0513
YFM350FW BIG BEAR 4X4 97	2112-0513
YFM350FW BIG BEAR 4X4 98-99	2112-0515
YFM350FWJ BIG BEAR 4WD SE 97	2112-0515
YFM350SE BIG BEAR 4WD 97	2112-0515
YFM350 BRUIN 04-06	2112-0890
YFM350 GRIZZLY 07-12	2112-0890

FITS MODEL	PART #
STATORS (CON'T)	
YAMAHA (CON'T)	
YFM350 WOLVERINE 06-09	2112-0890
YFM400 BIG BEAR 98-99	2112-0515
YFM400 BIG BEAR 00-01	2112-0505
YFM400 BIG BEAR 02-11	2112-0505
YFM400 GRIZZLY 07	2112-0519
YFM400 KODIAK 96-98	2112-0513
YFM400 KODIAK 99	2112-0520
YFM400 KODIAK 2WD 00-01	2112-0519
YFM400 KODIAK 2WD 03-04	2112-0519
YFM400 KODIAK 4WD 00-02	2112-0519
YFM450 GRIZZLY 4WD 07-11	2112-0519
YFM450 KODIAK 4WD 03-06	2112-0519
YXR450 RHINO 06-09	2112-0970
YFM600 GRIZZLY 98	2112-0516
YFM600 GRIZZLY 99-01	2112-0516
YFM660 GRIZZLY 02-06	2112-0522 ⁶
YXR660 RHINO 04-07	2112-0522 ⁶
YFM700 GRIZZLY 07-09	2112-0775
YFM700 GRIZZLY 10	2112-0775

FOOTNOTES

- ¹ FOR EARLY 97, MUST USE WIRE HARNESS CONNECTOR PART #2120-0242
- ² MUST USE WIRE HARNESS CONNECTOR PART #2120-0242
- ³ GROMMET AND CONNECTORS NOT INCLUDED
- ⁴ NO GROMMET, REUSE OLD ONE
- ⁵ 1 OF 3 POSSIBLE STATORS FOR APPLICATIONS LISTED. HAS OUTSIDE DIAMETER OF 103MM. NO GROMMET, CONNECTOR, OR TRIGGER COIL. ONE LESS WIRE THAN OE.
- ⁶ HIGH-OUTPUT STATOR
- ⁷ 1 OF 3 POSSIBLE STATORS FOR APPLICATIONS LISTED. HAS OUTSIDE DIAMETER OF 103MM. NO GROMMET, CONNECTOR, OR TRIGGER COIL.
- ⁸ NO GROMMET/TRIGGER. REUSE OLD ONES
- ⁹ NO TRIGGER
- ¹⁰ IF OEM REG/REC HAS A GANG PLUG ATTACHED DIRECTLY TO THE REG/REC BODY, USE PART #2112-0534. IF IT HAS PLUGS COMING OFF WITH WIRE LEADS USE PART #2112-0536.
- ¹¹ RE-USE LARGE 8-PLACE CONNECTOR. COMPLETE INSTALLATION INSTRUCTIONS INCLUDED.
- ¹² LARGE 8-PLACE CONNECTOR NEEDS TO BE REUSED AND OTHER SMALL MODIFICATIONS NEED TO BE MADE. COMPLETE INSTALLATION INSTRUCTIONS INCLUDED.
- ¹³ REPLACES OEM #S 3089546 AND 3089249. NO CONNECTORS
- ¹⁴ THERE ARE 2 DIFFERENT STATORS LISTED FOR THE 04 SPORTSMAN 400 (DEPENDING ON THE MODEL). THE WAY TO TELL THE DIFFERENCE IS BY THE # OF POLES; THIS IS AN 18-POLE STATOR. REPLACES OEM #S 3089546 AND 3089249. NO CONNECTORS.
- ¹⁵ NO CONNECTORS
- ¹⁶ REPLACES ONLY OEM STATOR THAT HAS 2 SOURCE COILS
- ¹⁷ REPLACES ONLY OEM STATOR THAT HAS 1 SOURCE COILS
- ¹⁸ FITS SERIAL #S 02-00894 AND UP
- ¹⁹ FITS SERIAL #S 02-02358 AND UP
- ²⁰ FOR 04 SPORTSMAN 600/700, POLARIS USED MULTIPLE STATORS. FOR THE CORRECT PART, CHECK THE PHYSICAL DESCRIPTION. THIS IS A 12-POLE STATOR WITH A SOURCE COIL. HAS A 390 OHM TRIGGER. REPLACES OEM #S 2202602 AND 4010709.
- ²¹ REPLACES OEM #S 3089959 AND 3089906
- ²² FITS SERIAL #S 02-02274 AND UP
- ²³ REPLACES OEM #4010796; ADDITIONAL PLUG INCLUDED TO MAKE DIRECT PLUG-IN UNIT
- ²⁴ 04 SPORTSMAN 600/700, POLARIS USED 3 STATORS. 18-POLE STATOR, OD IS 108MM, THICKNESS IS 18MM. THIS IS THE "KOKUSAN" STYLE STATOR. FOR 05 SPORTSMAN 700 NON EFI: THERE ARE 2 STATORS. REPLACES OEM # 4010901, REC/REG (IF BUILT BETWEEN 2/17/03 AND 4/05/04).
- ²⁵ FOR 04 SPORTSMAN 600/700, POLARIS USED MULTIPLE STATORS. FOR THE CORRECT PART, CHECK THE PHYSICAL DESCRIPTION. THIS IS A 12-POLE STATOR WITH A SOURCE COIL. HAS A 390 OHM TRIGGER. REPLACES OEM #2202602 AND 4010701, REC/REG (IF BUILT BETWEEN 2/17/03 AND 4/05/04).
- ²⁶ 04 SPORTSMAN 600/700, POLARIS USED 3 DIFFERENT STATORS. THIS IS AN 18 POLE STATOR; OD IS 108MM, THICKNESS IS 26MM. IT ALSO HAS AN ODD 6-GANG CONNECTOR (WHITE MOLDED PLASTIC W/ CLIPS SIDES AND USES STANDARD 250 FEMALE SPADE TERMINALS). REPLACES OEM # 4010911, REC/REG (IF BUILT BETWEEN 2/17/03 AND 4/05/04).
- ²⁷ FOR 04 SPORTSMAN 600/700, POLARIS USED MULTIPLE STATORS. FOR THE CORRECT PART, CHECK THE PHYSICAL DESCRIPTION. THIS IS A 12-POLE STATOR WITH A SOURCE COIL. HAS A 390 OHM TRIGGER. REPLACES OEM #S 2202602 AND 4010711, REC/REG (IF BUILT BETWEEN 2/17/03 AND 4/05/04).
- ²⁸ 04 SPORTSMAN 600/700, POLARIS USED 3 DIFFERENT STATORS. THIS IS AN 18 POLE STATOR; OD IS 108MM, THICKNESS IS 26MM. IT ALSO HAS AN ODD 6-GANG CONNECTOR (WHITE MOLDED PLASTIC W/ CLIPS SIDES AND USES STANDARD 250 FEMALE SPADE TERMINALS). REPLACES OEM # 4010911.



REGULATOR/RECTIFIERS

OEM style replacement units. All regulator/rectifiers are designed as direct plug in units with all the correct connectors and terminals (unless otherwise noted). Heavy-duty parts also available that will regulate additional electrical current.

FITS MODEL	PART #
REGULATOR/RECTIFIERS	
ARCTIC CAT	
250 2X4 99-00	2112-0553
250 2X4 01 (EARLY 01)	2112-0553
250 2X4 01 (LATE 01)	2112-0555
250 2X4 02	2112-0553
250 2X4 03 (EARLY 03)	2112-0553
250 2X4 03 (LATE 03)	2112-0555
250 2X4 04-05	2112-0555
250 4X4 00	2112-0553
250 4X4 01 (EARLY 01)	2112-0553
250 4X4 01 (LATE 01)	2112-0555
250 4X4 02	2112-0553
250 4X4 03 (EARLY 03)	2112-0553
250 4X4 03 (LATE 03)	2112-0555
250 4X4 04-05	2112-0555
300 2X4 05	2112-0555
300 2X4 98-01	2112-0553
300 2X4 02-03	2112-0555
300 4X4 98-00	2112-0553
300 4X4 01 (EARLY 01)	2112-0553
300 4X4 01 (LATE 01)	2112-0555
300 4X4 02-05	2112-0555
375 2X4 AUTOMATIC 02	2112-0554
375 4X4 AUTOMATIC 02	2112-0554
400 2X4 98-99	2112-0556
400 2X4 00	2112-0557
400 4X4 98-99	2112-0556
400 4X4 00	2112-0557
400 MANUAL 4X4 03	2112-0554
400 4X4 AUTOMATIC 03-04	2112-0554
400 2X4 MANUAL 01 (EARLY 01)	2112-0557
400 2X4 MANUAL 01 (LATE 01)	2112-0554
400 2X4 MANUAL 02	2112-0554
400 4X4 MANUAL 01 (EARLY 01)	2112-0557
400 4X4 MANUAL 01 (LATE 01)	2112-0554
400 4X4 MANUAL 02/04	2112-0554
400 4X4 MANUAL 03	2112-0554
400 AUTOMATIC 08	2112-0554
400ACT 4X4 AUTOMATIC 04	2112-0554
400ACT 4X4 MANUAL 04	2112-0554
400FIS AUTOMATIC 05-07	2112-0554
400FIS 2X4 AUTOMATIC 03-04	2112-0554
400FIS 4X4 AUTOMATIC 03-04	2112-0554
400FIS MANUAL 05-07	2112-0554
400FIS 2X4 MANUAL 02	2112-0554
400FIS 2X4 MANUAL 03-04	2112-0554
400FIS 4X4 MANUAL 02	2112-0554
400FIS 4X4 MANUAL 03-04	2112-0554
400TBX 4X4 AUTOMATIC 05-06	2112-0554
400TRV 06-07	2112-0554
400 TRV 11	2112-0963
400 TRV HI 10	2112-0963
400VP 4X4 AUTOMATIC 05-06	2112-0554
400VP 4X4 MANUAL 05-06	2112-0554
450 GT UTILITY MODEL 12	2112-0963
450 HI EFI 10	2112-0963
450 TRV 11-12	2112-0963
450 TRV GT 12	2112-0963
450 UTILITY MODEL 11-12	2112-0963
454 2X4 BEARCAT 97-98	2112-0556
454 4X4 97-98	2112-0556
454 BEARCAT 4X4 96	2112-0556
500 4X4 98-99	2112-0556

FITS MODEL	PART #
REGULATOR/RECTIFIERS (CONT)	
ARCTIC CAT (CONT)	
500 AUTO 08-09	2112-0554
500 AUTOMATIC 4X4 00-02	2112-0554
500 AUTO LE 08-09	2112-0554
500 4X4 MANUAL 00	2112-0557
500 4X4 MANUAL 01 (EARLY 01)	2112-0557
500 4X4 MANUAL 01 (LATE 01)	2112-0554
500 4X4 MANUAL 02	2112-0554
500 MANUAL 08-09	2112-0554
500FIS 4X4 AUTOMATIC 02	2112-0554
500FIS AUTOMATIC 03-07	2112-0554
500FIS 4X4 AUTOMATIC CAT 08	2112-0554
500FIS MANUAL 02	2112-0554
500FIS MANUAL 03-07	2112-0554
500FIS 4X4 MANUAL CAT 08	2112-0554
500TBX 4X4 AUTOMATIC 02	2112-0554
500TBX 4X4 AUTOMATIC 03-05	2112-0554
500TBX 4X4 AUTOMATIC 06	2112-0554
500TRV 4X4 AUTOMATIC CAT 03-05	2112-0554
500TRV 4X4 AUTOMATIC CAT 06	2112-0554
500 TRV HI EFI 09-10	2112-0963
500 TRV HI EFI LE 09	2112-0963
550 CRUISER GT 12	2112-0963
550 CRUISER PS 11	2112-0963
550 GT UTILITY MODEL 12	2112-0963
550 HI EFI 09-10	2112-0963
550 LTD UTILITY MODEL 11-12	2112-0963
550 PROWLER HI EFI 09	2112-0963
550 PROWLER XT 10-14	2112-0963
550 PS 11	2112-0963
550 S EFI 10	2112-0963
550 TRV GT 11-12	2112-0963
550 TRV S EFI 10	2112-0963
550 UTILITY MODEL 11-12	2112-0963
650 HI 08	2112-0963
650 HI 10-11	2112-0963
650 HI FIS 07-08	2112-0963
650 HI FIS LE 07-09	2112-0963
650 HI INTERNATIONAL 10	2112-0963
650 HI LE 05	2112-0963
650 HI SE 06	2112-0963
650 MUDPRO HI 10	2112-0963
650 PROWLER 07-08	2112-0963
650 PROWLER XT 06-09	2112-0963
650 TBX HI 07-09	2112-0963
650 TRV HI 07-09	2112-0963
650 TRV HI LE 07-09	2112-0963
650 UTILITY MODEL 11	2112-0963
700 CRUISER 12	2112-0963
700 CRUISER PS 11	2112-0963
700 GT UTILITY MODEL 12	2112-0963
700 HI EFI 08-09	2112-0963
700 LTD UTILITY MODEL 11-12	2112-0963
700 MUDPRO 11-12	2112-0963
700 MUDPRO HI EFI 09-10	2112-0963
700 MUDPRO LTD 12	2112-0963
700 PROWLER HDX 11-12	2112-0963
700 PROWLER XT HI EFI 09	2112-0963
700 PROWLER XT 08-12	2112-0963
700 TBX GT 12	2112-0963
700 TBX HI EFI 10	2112-0963
700 TBX LTD 11	2112-0963
700 TRV 11	2112-0963
700 TRV EFI 08	2112-0963
700 TRV GT 11-12	2112-0963
700 TRV HI EFI 10	2112-0963
700 TRV HI EFI CRUISER 09-10	2112-0963
700 TRV S EFI 10	2112-0963
700 EFI 08	2112-0963
700 EFI FIS 07	2112-0963
700 EFI FIS LE 07	2112-0963
700 EFI LE 08	2112-0963
700 EFI SE 06	2112-0963
700 UTILITY MODEL 11-12	2112-0963
1000 CRUISER 12	2112-0963
1000 GT UTILITY MODEL 12	2112-0963
1000 LTD UTILITY MODEL 11	2112-0963
1000 MUDPRO 11	2112-0963
1000 MUDPRO H2 10	2112-0963
1000 MUDPRO LTD 12	2112-0963
1000 PROWLER XT 09-11, 13-14	2112-0963

FITS MODEL	PART #
REGULATOR/RECTIFIERS (CONT)	
ARCTIC CAT (CONT)	
1000 THUNDERCAT H2 09	2112-0963
1000 THUNDERCAT H2 LE 10	2112-0963
1000 TRV GT 12	2112-0963
1000 TRV GT INT. 12	2112-0963
1000 TRV H2 EFI 10	2112-0963
1000 TRV H2 EFI CRUISER 10	2112-0963
CAN-AM	
OUTLANDER 330 2X4 04-05	2112-0716
OUTLANDER 330 4X4 04	2112-0716
OUTLANDER 330 STD 4X4 05	2112-0716
OUTLANDER 330 XT 4X4 05	2112-0716
OUTLANDER 400 2X4 03-05	2112-0716
OUTLANDER 400 4X4 04	2112-0716
OUTLANDER 400 EFI STD/XT 08-10	2112-0540
OUTLANDER 400 MAX 04-05	2112-0716
OUTLANDER 400 STD 4X4 05	2112-0716
OUTLANDER 400 XT 4X4 04-05	2112-0716
OUTLANDER 400 MAX STD EFI 08-10	2112-0540
OUTLANDER 400 MAX STD EFI 08-14	2112-0540
OUTLANDER 400 MAX XT EFI 08-14	2112-0540
OUTLANDER 400 STD EFI 08-14	2112-0540
OUTLANDER 400 XT EFI 08-14	2112-0540
OUTLANDER 500 EFI 09-10	2112-0540
OUTLANDER 500 STD/XT 4X4 07-08	2112-0540
OUTLANDER MAX 500 STD/XT 4X4 07-08	2112-0540
OUTLANDER MAX 500 EFI STD/XT 4X4 07-08	2112-0540
OUTLANDER 500 MAX STD EFI 09-14	2112-0540
OUTLANDER 500 STD EFI 09-14	2112-0540
OUTLANDER 650 EFI 09-10	2112-0540
OUTLANDER 650 EFI XT 09	2112-0540
OUTLANDER 650 STD 4X4 06-08	2112-0540
OUTLANDER 650 STD EFI 06-14	2112-0540
OUTLANDER 650 XT 4X4 06-08	2112-0540
OUTLANDER MAX 650 STD 4X4 06-08	2112-0540
OUTLANDER MAX 650 XT 4X4 06-08	2112-0540
OUTLANDER 650 MAX EFI 09-10	2112-0540
OUTLANDER 650 MAX EFI XT 09	2112-0540
OUTLANDER 650 MAX STD EFI 09-14	2112-0540
OUTLANDER 800 STD 4X4 06-08	2112-0540
OUTLANDER 800 XT 4X4 06-08	2112-0540
OUTLANDER MAX 800 LTD 4X4 07-08	2112-0540
OUTLANDER MAX 800 STD 4X4 06-08	2112-0540
OUTLANDER MAX 800 XT 4X4 06-08	2112-0540
OUTLANDER 800R EFI 09-14	2112-0540
OUTLANDER 800R EFI XT 09	2112-0540
OUTLANDER 800R MAX EFI 09-12	2112-0540
OUTLANDER 800R MAX EFI XT 09	2112-0540
E-TON	
AXL50 LIGHTNING 00-01	2112-0551
RXL50 VIPER 02-04	2112-0551
TXL50 THUNDER (ALL)	2112-0551
RXL70 VIPER 2-STROKE 04-07	2112-0551
AXL90 LIGHTNING 2-STROKE (ALL)	2112-0551
DXL90 SIERRA 2-STROKE 00-05	2112-0551
RXL90 VIPER 2-STROKE 02-07	2112-0551
TXL90 THUNDER 2-STROKE 00-01	2112-0551
HONDA	
TRX90 SPORTRAX 93-05	2112-0545
ATC125M 84-85	2112-0671
TRX125 85-86	2112-0671
ATC200ES BIG RED 82-84	2112-0668
TRX200 84	2112-0668
ATC250ES 85-87	2112-0881
ATC250SX 85-87	2112-0881
TRX250 UTILITY MODEL 85-87	2112-0881
TRX300 FOURTRAX 2X4/4X4 88-92	2112-0525
TRX300 FOURTRAX 2X4/4X4 93-00	2112-0526
TRX350FE RANCHER ES 4X4 00-06	2112-0527
TRX350FM RANCHER S 4X4 00-06	2112-0527
TRX350TE RANCHER ES 00-06	2112-0527
TRX350TM RANCHER S 00-06	2112-0527
TRX400FW FOREMAN 95-03	2112-0527
TRX420 FOURTRAX RANCHER (ALL MODELS) 14-16	2112-1152
TRX450FM FOREMAN FOURTRAX 02-04	2112-0527
TRX450S/ES FOREMAN 98-01	2112-0527
TRX500FA FOREMAN RUBICON 05-09	2112-1152
TRX500FE FOREMAN 4X4 ES 05-09/11	2112-1152

FITS MODEL	PART #
REGULATOR/RECTIFIERS (CONT)	
HONDA (CONT)	
TRX500F6A FOREMAN RUBICON	
GPS 05-09, 11-16	2112-1152
TRX500FM FOREMAN 4X4 05-09, 11-16	2112-1152
TRX500 FPA FOURTRAX FOREMAN	
RUBICON 09/11-16	2112-1152
TRX500TM FOREMAN 05-06	2112-1152
TRX500FPE FOURTRAX EPS 4X4 07-09, 11-16	2112-1152
PIONEER 500 15-16	2112-1152
TRX680 FOURTRAX RINCON 06-16 (ALL)	2112-1152
PIONEER 700 14-16	2112-1152
KAWASAKI	
KLF185 BAYOU 85-87	2112-1001
KLF220 BAYOU 88-95	2112-1001
KLF250 BAYOU 03-11	2112-0535
KEF300A LAKOTA 95-00	2112-0534
KEF300B LAKOTA SPORT 01-03	2112-0534
KLF300A BAYOU 86-87	2112-0533
KLF300B BAYOU 88-91	2112-0533
KLF300C BAYOU 89-91	2112-0533
KVF300 PRAIRIE 99-02	2112-0536
KVF360 PRAIRIE 2X4/4X4 03-12	2112-0536
KVF400D PRAIRIE 99-02	2112-0536
KVF400D PRAIRIE 99-02	2112-0536
KVF650 BRUTE FORCE 4X4 05-11	2112-0536
KVF650 PRAIRIE 02-03	2112-0536
KVF650I BRUTE FORCE 4X4I 07-11	2112-0537
KFX700 04-09	2112-0536
KSV700 V-FORCE 04-09	2112-0536
KVF700 PRAIRIE 4X4 04-06	2112-0536
KVF750I BRUTE FORCE 4X4I 05-07	2112-0537
KVF750I BRUTE FORCE 4X4I 08-09	2112-0537
KVF750I BRUTE FORCE 4X4I 12-16	2112-1251
KRT750 TERYX4 ALL MODELS 12-13	2112-1251
KRF800 TERYX ALL MODELS 14-16	2112-1251
KRT800 TERYX4 ALL MODELS 14-16	2112-1251
KYMCO	
MXU 150 05-11	2112-0993
MXU 250 04-11	2112-0993
MXU 300 05-11	2112-0993
MONGOOSE 250 03-08	2112-0993
MONGOOSE 300 05-07	2112-0993
POLARIS	
SPORTSMAN 90 01-06	2112-0551
SPORTSMAN 90 (4-STROKE) 07-14	2112-0964
SVR 150 17-18	2112-1310
PHOENIX 200 05-13	2112-0883
SAWTOOTH 200 06-07	2112-0883
TRAIL BLAZER 250 91-98	2112-0546
TRAIL BLAZER 250 99-03	2112-0550
TRAIL BOSS 250 99	2112-0546
XPLORER 250 01-02	2112-0550
XPLORER 300 99	2112-0546
XPLORER 300 4X4 99	2112-0546
MAGNUM 325 2X4 00-02	2112-0548
MAGNUM 325 4X4 00-02	2112-0548
TRAIL BOSS 325 00-02	2112-0548
XPEDITION 325 00	2112-0548
XPEDITION 325 01-02	2112-0548
SPORTSMAN 335 99-00	2112-0548
SPORTSMAN 400 94-97	2112-0549
SPORTSMAN 400 01-02	2112-0548
SPORTSMAN 400 4X4 03-04	2112-0966
XPLORER 400 98-02	2112-0548
XPLORER 400 4X4 95	2112-0548
XPLORER 400L 96-97	2112-0549
XPRESS 400L 96	2112-0549
MAGNUM 425 4X4 96-97	2112-0549
XPEDITION 425 00-02	2112-0548
MAGNUM 500 4X4 98	2112-0547
MAGNUM 500 4X4 99	2112-0547
MAGNUM 500 4X4 00 (EARLY 00)	2112-0547
MAGNUM 500 4X4 00 (LATE 00)	2112-0547
MAGNUM 500 4X4 01	2112-0547
MAGNUM 500 4X4 02 (EARLY 02)	2112-0547
MAGNUM 500 4X4 02 (LATE 02)	2112-0547
MAGNUM 500 4X4 03	2112-0966
ATP500 4X4 04	2112-0966
SPORTSMAN 500 4X4 96-97	2112-0549
SPORTSMAN 500 4X4 98-99	2112-0547
SPORTSMAN 500 4X4 00 (EARLY 00)	2112-0547

FITS MODEL	PART #
REGULATOR/RECTIFIERS (CONT)	
POLARIS (CONT)	
SPORTSMAN 500 4X4 00 (LATE 00)	2112-0547
SPORTSMAN 500 4X4 01	2112-0547
SPORTSMAN 500 4X4 02 (EARLY 02)	2112-0547
SPORTSMAN 500 4X4 02 (LATE 02)	2112-0547
SPORTSMAN 500 4X4 03	2112-0966
SPORTSMAN 500 4X4 04 (NON-EFI)	2112-0966
SPORTSMAN 500 6X6 00	2112-0547
SPORTSMAN 500 6X6 01	2112-0547
SPORTSMAN 500 6X6 02 (EARLY 02)	2112-0547
SPORTSMAN 500 6X6 02 (LATE 02)	2112-0547
SPORTSMAN 500 6X6 03	2112-0966
SPORTSMAN 500 6X6 98	2112-0547
SPORTSMAN 500 6X6 99 ONLY	2112-0547
WORKER 500 98-00	2112-0547
WORKER 500 01	2112-0547
WORKER 500 02 (EARLY 02)	2112-0547
WORKER 500 02 (LATE 02)	2112-0547
XPLORER 500 97	2112-0549
RANGER 570/CREW 14-15	2112-1310
RZR 570 EFI 12	2112-1254
RZR 570 13-16	2112-1310
SPORTSMAN 600 03	2112-0966
SPORTSMAN 600 04	2112-0966
SPORTSMAN 600 04	2112-0552
SPORTSMAN 600 04	2112-0552
SPORTSMAN 700 02-EARLY 03 AND EARLY 04	2112-0966
SPORTSMAN 700 04	2112-0552
SPORTSMAN ACE 325/570/900 ALL MODELS 15-16	2112-1252
SPORTSMAN ACE 325 ALL MODELS 14	2112-1254
RANGER 800/CREW 11-16	2112-1310
RANGER 800 XP 12	2112-1310
RZR/S/4 800 EFI 11-14	2112-1310
RZR 900 ALL MODELS 14	2112-1252
RZR XP 4 900 ALL MODELS 13	2112-1252
RZR XP 900 ALL MODELS 13	2112-1252
RZR4 900 ALL MODELS 14	2112-1252
RANGER 900 CREW ALL MODELS 14-15	2112-1253
RANGER 900 XP ALL MODELS 13-15	2112-1253
RZR 900 ALL MODELS 15	2112-1253
RZR S 900 ALL MODELS 15	2112-1253
RZR XC 900 15	2112-1253
RZR XP 4 900 ALL MODELS 12	2112-1254
RZR XP 900 ALL MODELS 12	2112-1254
RZR XP 1000 ALL MODELS 14-16	2112-1252
RZR XP 1000 TURBO 16	2112-1253
RZR XP 1000 TURBO 18	2112-1310
SUZUKI	
LT160 88-92	2112-0530
LT-F 160 QUADRUNNER 160 91-04	2112-0530
LT-F 250 QUADRUNNER 250 88-89	2112-0530
LT-F 250 QUADRUNNER 250 90-01	2112-0530
LT-F 250 QUADRUNNER 250F 02	2112-0672
LT-F 250F KING QUAD 4X4 00	2112-0530
LT-F 250F KING QUAD 4X4 01	2112-0530
LT250 OZARK 02-09/12-14	2112-0962
LT-4WD QUADRUNNER 4WD 87-95	2112-0530
LT-4WD QUADRUNNER 4WD 88-96	2112-0530
LT-F 300F KING QUAD 99-00	2112-0530
LT-F 300F KING QUAD 01	2112-0530
LT-F 300F KING QUAD 02	2112-0672
LT-F 4WD KING QUAD 91-98	2112-0530
LT-F4WD 97-98	2112-0530
LT-F 4WD KING QUAD 97-98	2112-0530
LT-A400 EIGER 2WD 02-07	2112-0673
LT-A400F EIGER 4WD 02-07	2112-0673
LT-A400F KINGQUAD 08-09	2112-0673
LT-A450X KING QUAD 07-09	2112-0882
LT-A500F QUADMASTER 00	2112-0531
LT-A500F VINSON 4X4 AUTOMATIC 02-07	2112-0882
LT-A500X KING QUAD 09	2112-0882
LT-A500X KING QUAD 11-12	2112-0882
LT-F500F QUADRUNNER 98-99	2112-0529
LT-F500F QUADRUNNER 00	2112-0531
LT-F500F QUADRUNNER 01	2112-0532
LT-F500F QUADRUNNER 02	2112-0532
LT-F500F VINSON 4X4 MANUAL 04-07	2112-0882
LT-V700F TWIN PEAKS 04-05	2112-0536
LT-A700X KING QUAD 4X4 06-07	2112-0882
LT-A750X KING QUAD 08-09	2112-0882
LT-A750X KING QUAD 11	2112-0882

FITS MODEL	PART #
REGULATOR/RECTIFIERS (CONT)	
YAMAHA	
YFM125 GRIZZLY 04-11	2112-0541
YFB250F TIMBERWOLF 94-96	2112-0544
YFB250F TIMBERWOLF 97-00	2112-0543
YFM250 89-91	2112-0542
YFM250 BEAR TRACKER 99-00	2112-0543
YFM250 BEAR TRACKER 01-03	2112-0541
YFM250 BEAR 07-10	2112-0541
YFM250 BRUIN 05-06	2112-0541
YFM250X BEAR TRACKER 04	2112-0541
YFM350 BIG BEAR 87	2112-0542
YFM350 BIG BEAR 88-89	2112-0542
YFM350 BIG BEAR 90-94	2112-0542
YFM350 BIG BEAR 95	2112-0544
YFM350 BIG BEAR 2WD 98	2112-0543
YFM350 BIG BEAR 2X4 97	2112-0543
YFM350 BRUIN 2X4/4X4 04-06	2112-0541
YFM350 GRIZZLY 07-12	2112-0541
YFM350 MOTO 4 88-89	2112-0542
YFM350 MOTO 4 90-94	2112-0542
YFM350 MOTO 4 95	2112-0544
YFM350 WARRIOR 87	2112-0542
YFM350 WARRIOR 88-89	2112-0542
YFM350 WARRIOR 90-95	2112-0542
YFM350 WARRIOR 96-01	2112-0543
YFM350 WOLVERINE 95-99	2112-0543
YFM350 WOLVERINE 00-01	2112-0543
YFM350 WOLVERINE 06-09	2112-0541
YFM350FV BIG BEAR 4X4 96	2112-0544
YFM350FV BIG BEAR 4X4 97	2112-0543
YFM350FV BIG BEAR 4X4 98-99	2112-0543
YFM350FWB BIG BEAR 4WD SE 97	2112-0543
YFM350SE BIG BEAR 4WD 97	2112-0543
YFP350 TERRAPRO 88	2112-1100
YFM400 BIG BEAR 98-99	2112-0543
YFM400 BIG BEAR 00-01	2112-0543
YFM400 BIG BEAR 02-11	2112-0541
YFM400 GRIZZLY 07	2112-0541
YFM400 KODIAK 93-95	2112-0544
YFM400 KODIAK 96-98	2112-0543
YFM400 KODIAK 99	2112-0543
YFM400 KODIAK 2WD 00-01	2112-0541
YFM400 KODIAK 2WD 03-04	2112-0541
YFM400 KODIAK 4WD 00-02	2112-0541
YFM450 GRIZZLY 4WD 07-11	2112-0541
YFM450 KODIAK 4WD 03-06	2112-0541
YFM450 WOLVERINE SPORT 4X4 06-08	2112-0541
YXR450 RHINO 06-09	2112-0539
YFM600 GRIZZLY 98	2112-0543
YFM600 GRIZZLY 99-01	2112-0541
YFM660 GRIZZLY 02-06	2112-0539
YFM660 GRIZZLY 07-08	2112-0539
YXR660 RHINO 04-07	2112-0539
YFM700 GRIZZLY 07-09	2112-0540
YFM700 GRIZZLY 10	2112-0775

PLOWS
WINCHES
UTV
RACKS
IMPLEMENT & TOWING
LUGGAGE
BODY
CONTROLS
ELECTRICAL
WHEELS & TIRES
SUSPENSION & DRIVE
BRAKING
ENGINE
RIDER
GARAGE
PROMO



NEW FITMENTS FOR TGB



STARTERS

Built to OEM specifications. Direct bolt-on replacements.

FITS MODEL	PART #
STARTERS	
ARCTIC CAT	
90 4-STROKE 2X4 AUTO 04-05	2110-0508
90 Y-12 YOUTH - UTILITY 05	2110-0508
250 2X4 99-05	2110-0344
250 4X4 00-05	2110-0344
300 2X4 99-03	2110-0344
300 4X4 98-05	2110-0344
375 2X4 AUTOMATIC 02	2110-0346
375 4X4 AUTOMATIC 02	2110-0346
400 4X4 AUTOMATIC 03/08	2110-0346
400 4X4 MANUAL 03	2110-0346
400ACT 4X4 AUTOMATIC 04	2110-0346
400ACT 4X4 MANUAL 04	2110-0346
400FIS 2X4 AUTOMATIC 03-04	2110-0346
400FIS 2X4 MANUAL 03-04	2110-0346
400FIS 4X4 AUTOMATIC 03-04	2110-0346
400FIS 4X4 MANUAL 03-04	2110-0346
400FIS AUTOMATIC 05-07	2110-0346
400FIS MANUAL 05-07	2110-0346
400TBX 4X4 AUTOMATIC 04-06	2110-0346
400TRV 06-07	2110-0346
400VP 4X4 AUTOMATIC 05-06	2110-0346
400VP 4X4 MANUAL 05-06	2110-0346
500 AUTO 4X4 00-02	2110-0419
500 AUTO 4X4 08	2110-0419
500 AUTO LE 08-09	2110-0419
500 MANUAL 4X4 08-09	2110-0419
500 TRV CORE 13	2110-0539
500 TRV HI EFI 09-10	2110-0539
500 TRV HI EFI LE 09	2110-0539
500 XT UTILITY MODEL 13 (W/ OE STARTER #S 0825-011/0825-013/0825-024)	2110-0539
500FIS AUTO 4X4 02-08	2110-0419
500FIS AUTO LE 05-06	2110-0419
500FIS MAN 4X4 03-08	2110-0419
500FIS MPR AUTO 04	2110-0419
500FIS MPR MANUAL 04	2110-0419
500TBX 4X4 AUTOMATIC 06	2110-0346
500TBX AUTO 4X4 02-05	2110-0419
500TRV AUTO 4X4 04-06	2110-0419
500TRV AUTO 4X4 08	2110-0419
550 CORE 13-14	2110-0539
550 GT CRUISER 12	2110-0539
550 GT UTILITY MODEL 12	2110-0539
550 HI EFI 09-10	2110-0539
550 HI EFI LE 09	2110-0539
550 LTD UTILITY MODEL 11-14	2110-0539
550 PROWLER HI EFI 09	2110-0539
550 PROWLER XT 10-11	2110-0539
550 PROWLER XT 13-14	2110-0539
550 PS 11	2110-0539
550 PS CRUISER 11	2110-0539
550 S EFI 10	2110-0539
550 TRV GT 11-12	2110-0539
550 TRV LTD 14	2110-0539
550 TRV S EFI 10	2110-0539
550 TRV XT 13-14	2110-0539
550 UTILITY MODEL 11-12	2110-0539
650 HI FIS 07	2110-0419
650 HI FIS LE 07	2110-0419
650 HI LE 05	2110-0419
650 HI SE 06	2110-0419
650 HI TBX 07	2110-0419
650 HI TRV 07	2110-0419
650 HI TRV LE 07	2110-0419
650 HI 08	2110-0539

FITS MODEL	PART #
STARTERS (CON'T)	
ARCTIC CAT (CON'T)	
650 HI 10	2110-0539
650 MUDPRO HI 10	2110-0539
650 PROWLER 08	2110-0539
650 PROWLER XT 08-09	2110-0539
650 TRV HI 08-09	2110-0539
650 UTILITY MODEL 11	2110-0539
700 CORE 14	2110-0539
700 GT UTILITY MODEL 12	2110-0539
700 HI EFI 08-09	2110-0539
700 HI EFI LE 09	2110-0539
700 LTD UTILITY MODEL 11-14	2110-0539
700 MUDPRO 11-13	2110-0539
700 MUDPRO HI EFI 09-10	2110-0539
700 MUDPRO LTD 12	2110-0539
700 MUDPRO LTD 14	2110-0539
700 PROWLER HDX 11-14	2110-0539
700 PROWLER XT 12	2110-0539
700 PROWLER XT HI EFI 09	2110-0539
700 PROWLER TX 08-12	2110-0539
700 PROWLER TX 14	2110-0539
700 PROWLER TX LE 09	2110-0539
700 PS CRUISER 11	2110-0539
700 TBX GT 12	2110-0539
700 TBX HI EFI 10	2110-0539
700 TBX LTD 11	2110-0539
700 TBX XT 13-14	2110-0539
700 TRV 11	2110-0539
700 TRV GT 12	2110-0539
700 TRV HI EFI CRUISER 09-10	2110-0539
700 TRV LTD 13-14	2110-0539
700 TRV S EFI 10	2110-0539
700 TRV XT 14	2110-0539
700 TRV EFI 08	2110-0475
700 XT UTILITY MODEL 13-14	2110-0539
700 CRUISER 12	2110-0539
700 EFI 08	2110-0475
700 EFI FIS 07	2110-0475
700 EFI FIS LE 07	2110-0475
700 EFI LE 08	2110-0475
700 EFI SE 06	2110-0475
700 UTILITY MODEL 11-12	2110-0539
1000 THUNDERCAT AUTO SE 08	2110-0539
1000 THUNDERCAT H2 09	2110-0539
CAN-AM	
OUTLANDER 330 STD 04-05	2110-0471
OUTLANDER 330 XT 05	2110-0471
OUTLANDER 400 03	2110-0471
OUTLANDER 400 MAX 04-05	2110-0471
OUTLANDER 400 MAX STD 06-08	2110-0471
OUTLANDER 400 MAX XT 06-08	2110-0471
OUTLANDER 400 STD 04-08	2110-0471
OUTLANDER 400 XT 04-08	2110-0471
TRAXTER 500 99-04	2110-0472
TRAXTER 500 5 SPEED 05	2110-0472
TRAXTER 500 AUTOSHIFT 01-02	2110-0472
TRAXTER 500 AUTOSHIFT STD 03-04	2110-0472
TRAXTER 500 AUTOSHIFT XT 03-04	2110-0472
TRAXTER 500 FOOTSHIFT 01	2110-0472
TRAXTER 500 MAX 03	2110-0472
TRAXTER 500 MAX STD 04-05	2110-0472
TRAXTER 500 MAX XT 04-05	2110-0472
TRAXTER 500 XL 01-05	2110-0472
TRAXTER 500 XT 01-05	2110-0472
OUTLANDER 500 MAX STD 07-08	2110-0473
OUTLANDER 500 MAX STD 07-08	2110-0473
OUTLANDER 500 MAX STD EFI 09-12	2110-0473
OUTLANDER 500 MAX XT 07-08	2110-0473
OUTLANDER 500 MAX XT 07-08	2110-0473
OUTLANDER 500 MAX XT EFI 09-12	2110-0473
OUTLANDER 500 STD 07-08	2110-0473
OUTLANDER 500 STD EFI 09-12	2110-0473
OUTLANDER 500 XT 07-08	2110-0473
OUTLANDER 500 XT EFI 09-12	2110-0473
OUTLANDER 500 XT 07-08	2110-0473
OUTLANDER 500 XT EFI 09-12	2110-0473
OUTLANDER 650 MAX STD 06-08	2110-0473
OUTLANDER 650 MAX STD EFI 09-12	2110-0473
OUTLANDER 650 MAX XT 06-08	2110-0473
OUTLANDER 650 MAX XT EFI 09-12	2110-0473

FITS MODEL	PART #
STARTERS (CON'T)	
CAN-AM (CON'T)	
OUTLANDER 650 STD 06-08	2110-0473
OUTLANDER 650 STD EFI 09-12	2110-0473
OUTLANDER 650 XT 06-08	2110-0473
OUTLANDER 650 XT EFI 09-12	2110-0473
OUTLANDER 800 MAX LTD 07-08	2110-0473
OUTLANDER 800 MAX STD 06-08	2110-0473
OUTLANDER 800 MAX XT 06-08	2110-0473
OUTLANDER 800 STD 06-08	2110-0473
OUTLANDER 800 XT 06-08	2110-0473
OUTLANDER 800R MAX LTD EFI 09-11	2110-0473
OUTLANDER 800R MAX STD EFI 09-12	2110-0473
OUTLANDER 800R MAX XT EFI 09-12	2110-0473
OUTLANDER 800R STD EFI 09-12	2110-0473
OUTLANDER 800R XMR EFI 11-12	2110-0473
OUTLANDER 800R XT EFI 09-12	2110-0473
OUTLANDER 1000 EFI 12	2110-0473
OUTLANDER 1000 XT EFI 12	2110-0473
CF MOTO	
CF500 ALL 07-09	2110-0537
CF500-2/A 11-12	2110-0537
X5 ALL 11-12	2110-0537
CF500 RANCHER (UTV) 11-12	2110-0537
X6 TERRALANDER 11-13	2110-0537
CF600 RANCHER (UTV) 11-13	2110-0537
Z6 TERRACROSS 600 (UTV) 12-13	2110-0537
Z6-EX TERRACROSS 625 (UTV) 12-13	2110-0537
X8 TERRALANDER 800 11-14	2110-0536
CF800 TRACKER (UTV) 11-14	2110-0536
E-TON	
AXL50 LIGHTNING (ALL)	2110-0358
RXL50 VIPER (ALL)	2110-0358
TXL50 THUNDER (ALL)	2110-0358
AXL90 LIGHTNING 2-STROKE (ALL)	2110-0359
DXL90 SIERRA 2-STROKE 00-05	2110-0359
RXL90 VIPER 2-STROKE 02-07	2110-0359
TXL90 THUNDER 2-STROKE 00-01	2110-0359
HONDA	
TRX200 FOURTRAX 90-97	2110-0420
ATC250ES BIG RED 85-86	2110-0328
ATC250ES BIG RED 87	2110-0331
ATC250SX 85-86	2110-0328
ATC250SX 87	2110-0331
TRX250 UTILITY MODEL 85-86	2110-0328
TRX250 UTILITY MODEL 87	2110-0331
TRX250 FOURTRAX RECON 97-07	2110-0334
TRX300 FOURTRAX 2X4/4X4 88-00	2110-0331
TRX350 FOURTRAX 85-86	2110-0329
TRX350 FOURTRAX 87-89	2110-0332
TRX350 RANCHER 00-06	2110-0330
TRX400FV FOURTRAX FOREMAN 95-03	2110-0335
TRX400 FOURTRAX RANCHER (ALL) 04-07	2110-0469
TRX420 RANCHER 10-14	2110-0954
TRX450ER 06-08	2110-0953
TRX450 FOURTRAX FOREMAN 98-04 (ALL)	2110-0335
TRX500 FOURTRAX FOREMAN 05-09/11 (ALL)	2110-0335
TRX500 RUBICON 00-03 (ALL)	2110-0336
TRX650 FOURTRAX RINCON (ALL) 03-05	2110-0474
TRX680 FOURTRAX RINCON (ALL) 06-13	2110-0474
KAWASAKI	
KLF220 BAYOU 88-02	2110-0338
KLF250 BAYOU 03-09	2110-0338
KAF300A MULE 500 90-93	2110-0340
KAF300B MULE 500 94-96	2110-0340
KAF300C MULE 550 97-04	2110-0340
KAF300D MULE 520 00-01	2110-0340
KLF300A BAYOU 86-87	2110-0337
KLF300B BAYOU 88-04	2110-0337
KLF300C BAYOU 89-04	2110-0337
KVF300 PRAIRIE 99-02	2110-0337
KAF400A MULE 610 4X4 05-12	2110-0341
KAF400B MULE 600 05-09	2110-0341
KAF400C MULE 610 4X4 05-08	2110-0341
KAF400D MULE 610 XC 10-12	2110-0341
KLF400B BAYOU 4X4 93-99	2110-0339
KVF400D PRAIRIE 97-02	2110-0339
KVF650 PRAIRIE 4X4 02-03	2110-0421

FITS MODEL	PART #
STARTERS (CON'T)	
KAWASAKI (CON'T)	
KVF650 BRUTE FORCE 4X4 05-06/09-13	2110-0421
KVF650I BRUTE FORCE 4X4I 06-07	2110-0421
KVF700 PRAIRIE 4X4 04-06	2110-0421
KVF750I BRUTE FORCE 4X4I 05-12	2110-0421
KAF620A MULE 2510 4X4 93-00	2110-0342
KAF620B MULE 2520 TURF 93-00	2110-0342
KAF620C MULE 2500 94-00	2110-0342
KRF750 TERYX 08	2110-0421
KRF750 TERYX FI/LE/SPORT 09-13	2110-0421
KRF750 TERYX 12-13	2110-0421
KAF620E MULE 3010 01-08	2110-0856
KAF620F MULE 3020 93	2110-0856
KAF620F MULE 3020 01-02	2110-0856
KAF620G MULE 3000 01-08	2110-0856
KAF620H MULE 3010 93	2110-0856
KAF620J MULE 3010 TRANS 06-08	2110-0856
KAF620M MULE 4010 09-12,14-16	2110-0856
KAF620P MULE 4000 09-12, 14-16	2110-0856
KAF620R MULE 4010 TRANS 09-12, 14-16	2110-0856
KAF620T/V MULE 4010 SE 16	2110-0856
KYMCO	
MXU 150 05-11	2110-0488
POLARIS	
SPORTSMAN 90 01-06	2110-0359
SPORTSMAN 90 (4-STROKE) 07-12	2110-0405
PHOENIX 200 05-13	2110-0360
SAWTOOTH 200 06-07	2110-0360
CYCLONE 250 87	2110-0354
SCRAMBLER 250 85-86	2110-0354
TRAIL BLAZER 250 90-06	2110-0354
TRAIL BOSS 250 88/90-91	2110-0354
TRAIL BOSS 250 2X4 87-92	2110-0354
TRAIL BOSS 250 4X4 85-99	2110-0354
XPLORER 250 00-02	2110-0354
300 2X4 94-95	2110-0354
300 4X4 94-95	2110-0354
300 6X6 94	2110-0354
TRAIL BOSS 300 2X4 95	2110-0354
TRAIL BOSS 300 4X4 95	2110-0354
XPLORER 300 4X4 95-02	2110-0354
XPRESS 300 96-99	2110-0354
HAWKEYE 300 2X4 06-11	2110-0521
HAWKEYE 300 4X4 06-07	2110-0521
SPORTSMAN 300 4X4 08-09	2110-0521
MAGNUM 325 2X4 00-02	2110-0355
MAGNUM 325 4X4 00-02	2110-0355
TRAIL BOSS 325 00-02	2110-0355
XPEDITION 325 00-02	2110-0520
MAGNUM 330 03-06	2110-0355
TRAIL BOSS 330 03-13	2110-0355
SPORTSMAN 335 99-00	2110-0355
WORKER 335 99	2110-0355
350L 2X4 93	2110-0354
350L 4X4 93	2110-0354
TRAIL BOSS 350L 2X4/4X4 90-92	2110-0354
SPORTSMAN 400 94-97	2110-0354
SPORTSMAN 400 01-05	2110-0355
SPORTSMAN 400 11-12	2110-0355
SPORTSMAN 400 HO 4X4 08-10	2110-0522
XPLORER 400 95-02	2110-0354
XPRESS 400L 96-97	2110-0354
XPEDITION 425 00-02	2110-0520
MAGNUM 425 2X4 95-98	2110-0355
MAGNUM 425 4X4 95-97/99	2110-0355
RANGER 425 2X4 03-04	2110-0355
SPORTSMAN 450 06-07	2110-0355
ATP 500 4X4 04-05	2110-0355
BIG BOSS 500 6X6 98-02	2110-0355
MAGNUM 500 4X4 99-03	2110-0355
SPORTSMAN 500 4X4 96-00	2110-0355
SPORTSMAN 500 6X6 98-08	2110-0355
SPORTSMAN 500 EFI HO 4X4 06-09	2110-0355
SPORTSMAN 500 EFI TRACTOR 10-12	2110-0355
SPORTSMAN 500 EFI X2 06-09	2110-0355
SPORTSMAN 500 HO 4X4 01-06/08-12	2110-0355
SPORTSMAN 500 X2 2-UP 06-08	2110-0355

FITS MODEL	PART #
STARTERS (CON'T)	
POLARIS (CON'T)	
SPORTSMAN TOURING 500 EFI 4X4 08-09	2110-0355
SPORTSMAN TOURING 500 HO 4X4 10-12	2110-0355
SPORTSMAN X 500 02	2110-0355
WORKER 500 99-02	2110-0355
XPLORER 500 97	2110-0355
SPORTSMAN 550 11-13	2110-0523
SPORTSMAN 550 EPS 10-13	2110-0523
SPORTSMAN 550 EPS INT 10	2110-0523
SPORTSMAN 550 X2 10-13	2110-0523
SPORTSMAN 550 X2 INT 11-13	2110-0523
SPORTSMAN 550 XP 09-10	2110-0523
SPORTSMAN 550 XP EPS 09	2110-0523
SPORTSMAN 550 XP LE 09	2110-0523
SPORTSMAN FOREST 550 11-13	2110-0523
SPORTSMAN TOURING 550 EPS 10-13	2110-0523
SPORTSMAN TOURING 550 EPS INT 13	2110-0523
SPORTSMAN TOURING 550 XP EPS INT 12	2110-0523
SPORTSMAN 600 03-05	2110-0356
SPORTSMAN 700 02-08	2110-0356
SPORTSMAN 800/EFI 4X4 05-13	2110-0356
SPORTSMAN 800 EFI HO 4X4 08-09	2110-0356
SPORTSMAN 800 EFI 6X6/FOREST 09-13	2110-0356
SPORTSMAN 800 EFI X2 07	2110-0356
SPORTSMAN TOURING 800 EFI 4X4 08-09	2110-0356
SPORTSMAN 850XP 09-13	2110-0406
SPORTSMAN FOREST 850 11-13	2110-0406
SPORTSMAN TOURING 850 EPS 2-PASS 11-13	2110-0406
SPORTSMAN 850XP ESP 10-13	2110-0406
RANGER 400 4X4 10-12	2110-0355
RANGER 500 2X4 05-08	2110-0355
RANGER 500 4X4 03-05	2110-0355
RANGER 500 4X4 06-07	2110-0355
RANGER 500 4X4 EFI 06-12	2110-0355
RANGER 500 6X6 99/03-05	2110-0355
RANGER 700 EFI 4X4 06-09	2110-0356
RANGER 700 EFI 6X6 06-09	2110-0356
RANGER TM 700 04-06	2110-0544
RANGER XP 700 4X4 06-07	2110-0356
RANGER 800 EFI 4X4 10-11	2110-0356
RANGER 800 EFI 6X6 10-12	2110-0356
RZR 800 EFI 08-10/12	2110-0356
RZR 800 EFI "S" MODEL 09-10/12	2110-0356
RZR 900 EFI XP 11	2110-0583
RZR 900 EFI XP 12	2110-0583
RANGER 900 CREW ALL 15	2110-0584
RANGER 900 XP ALL 13-15	2110-0584
RZR 900 ALL 14-15	2110-0584
RZR S 900 ALL 15	2110-0584
RZR XP 900 ALL 13	2110-0584
RZR XP 1000 ALL 14-15	2110-0584
RZR XP 4 1000 ALL 14-15	2110-0584
SPORTSMAN 450 HO 16	2110-0860
SPORTSMAN 570 ALL 14-16	2110-0860
SPORTSMAN 570 SP ALL 15-16	2110-0860
SPORTSMAN 570 X2 EPS 15-16	2110-0860
SPORTSMAN ACE 570 ALL 15-17	2110-0860
SPORTSMAN FOREST 570 ALL 14-15	2110-0860
SPORTSMAN TOURING 570 ALL 14-17	2110-0860
SUZUKI	
LT80 QUADSPORT 87-05	2110-0343
LT160 QUADRUNNER 03-04	2110-0423
LT160E QUADRUNNER 89-92	2110-0423
LT160 QUADRUNNER 91-01	2110-0423
LT230E QUADRUNNER 88-93	2110-0423
LT-F250 QUADRUNNER 250 88-99	2110-0344
LT-F250X 99	2110-0344
LT-F250 OZARK 02-09	2110-0423
LT-4WD QUADRUNNER 4WD 87-96	2110-0344
LT-F 300F KING QUAD 99	2110-0344
LT-F 4WDX KING QUAD 91-98	2110-0344
LT-F4WD 97-98	2110-0344
LT-F 4WD KING QUAD 97-98	2110-0344
LT-A4002WD EIGER 2WD 02-07	2110-0346
LT-A4004WD EIGER 4WD 02-07	2110-0346
LT-A400F KING QUAD 08-09	2110-0346
LT-A450X 07-09	2110-0389

FITS MODEL	PART #
STARTERS (CON'T)	
SUZUKI (CON'T)	
LT-A500X KING QUAD 09/11-12	2110-0389
LTA500F QUADMASTER 00-01	2110-0422
LTA500F VINSON 4X4 AUTO 02-07	2110-0422
LT-F500F QUADRUNNER 00-02	2110-0422
LT-F500F VINSON 4X4 MANUAL 04-07	2110-0422
LTA700X KINGQUAD 4X4 05-07	2110-0475
LTA750X KINGQUAD 08-09	2110-0475
TGB	
250 CONGO (ALL)	2110-0930
250 BLADE (ALL)	2110-0930
250 TARGET (ALL)	2110-0930
325 BLADE (ALL)	2110-0930
325 TARGET (ALL)	2110-0930
YAMAHA	
YFM80 BADGER 92-01	2110-0347
YFM80 GRIZZLY 05-08	2110-0347
YFM80 MOTO 4 85-91	2110-0347
YFM100 CHAMP 87-91	2110-0347
YFA125 BREEZE 89-04	2110-0353
YFM125 GRIZZLY 04-12	2110-0353
YFM200 MOTO 4 85-89	2110-0348
YTM200 TRI-MOTO CHAIN DRIVE 83-86	2110-0348
YTM200E TRI-MOTO SHAFT DRIVE 83-84	2110-0348
YTM200ER YAMAHUALER 85-86	2110-0348
YFM225 MOTO 4 86-88	2110-0348
YTM225DR TRI-MOTO 85-86	2110-0348
YTM225DX TRI-MOTO 83-85	2110-0348
YFB250F TIMBERWOLF 92-00	2110-0348
YFM250 89-91	2110-0348
YFM250 BEAR TRACKER 99-03	2110-0348
YFM250 BIG BEAR 09-10	2110-0348
YFM350 BIG BEAR 87-96	2110-0349
YFM350 BIG BEAR 2WD 96-98	2110-0349
YFM350 MOTO 4 87-95	2110-0349
YFM350 WARRIOR 87-03	2110-0349
YFM350 WOLVERINE 95-05	2110-0350
YFM350FV BIG BEAR 4X4 96	2110-0349
YFM350FV BIG BEAR 4X4 98-99	2110-0350
YFM350FVWJ BIG BEAR 4WD SE 97	2110-0350
YFM350 BIG BEAR 4WD 97	2110-0349
YFP350 TERRAPRO 88-89	2110-0349
YFM400 BIG BEAR 00-12	2110-0350
YFM400 GRIZZLY 07	2110-0352
YFM400 KODIAK 93-98	2110-0349
YFM400 KODIAK 99	2110-0350
YFM400 KODIAK 2WD 00-04	2110-0352
YFM400 KODIAK 4WD 00-06	2110-0352
YFM450 GRIZZLY 4WD 07-09	2110-0352
YFM450 KODIAK 4WD 03-06	2110-0352
YFM450 WOLVERINE SPORT 4X4 06-09	2110-0352
YFM600 GRIZZLY 98-01	2110-0352
YFM660 GRIZZLY 02-08	2110-0352
YXR660 RHINO 04-07	2110-0352
YFM700 GRIZZLY 07-08	2110-0470
YXR7F RHINO 700 (ALL) 08-09	2110-0470
YXR7F RHINO 700 (ALL) 11	2110-0470

PLOWS
WINCHES
UTV
RACKS
IMPLEMENT & TOWING
LUGGAGE
BODY
CONTROLS
ELECTRICAL
WHEELS & TIRES
SUSPENSION & DRIVE
BRAKING
ENGINE
RIDER
GARAGE
PROMO





PLOWS

WINCHES

UTV

RACKS

IMPLEMENTS
& TOWING

LUGGAGE

BODY

CONTROLS

ELECTRICAL

WHEELS
& TIRES

SUSPENSION
& DRIVE

BRAKING

ENGINE

RIDER

GARAGE

PROMO



SWITCHBACK™

SWITCHBACK TIRES

- 6-ply construction
- Aggressive tread design that works great in a full range of terrains from muddy to hard packed
- Tread pattern and wide footprint give exceptional traction
- Wide shoulder lugs protect sidewalls
- E-marked and REACH compliant
- Tubeless (TL)

SIZE	LOAD/SPEED INDEX	PLY	PART #
25X8 - 12	43J	6	0320-0841
25X10 - 12	50J	6	0320-0842
26X9 - 12	49J	6	0320-0843
26X11 - 12	55J	6	0320-0844
28X10 - 14	77J	6	0320-1015
30X10 - 14	80J	6	0320-1016



NEW SIZES





RIGID TIRES

- Built for the heaviest UTVs on the market
- 8-ply radial construction
- Very resistant to punctures
- Tread pattern and wide footprint give exceptional traction
- Wide shoulder lugs protect sidewalls
- Radial tire construction
- E-marked and REACH compliant

SIZE	LOAD/SPEED		PART #
	INDEX	PLY	
28X10 R14	59M	8	0320-0932
30X10 R14	63M	8	0320-0933
28X10 R15	58M	8	0320-0934
30X10 R15	63M	8	0320-0935
32X10 R15	66M	8	0320-0936



8 BALL TIRES

8-ply radial construction is built for the heaviest UTV's on the market. Tread design gives you traction in the mud but still rides good on hard packed surfaces. Better resistance against punctures. DOT and E-marked certified to meet the highest standards in the world.

SIZE	PLY	PART #
26X9R14	8	0319-0232
26X11R14	8	0319-0233



- PLOWS
- WINCHES
- UTV
- RACKS
- IMPLEMENTS & TOWING
- LUGGAGE
- BODY
- CONTROLS
- ELECTRICAL
- WHEELS & TIRES**
- SUSPENSION & DRIVE
- BRAKING
- ENGINE
- RIDER
- GARAGE
- PROMO





399X™

399X UTV WHEELS

Handles load capacities from 675 lbs for the 12x7, 14x7 front to 1150 lbs for the 12x8 and 14x8 rear which meet, or exceed all current market requirements.

Whether it's in the woods, deep mud or sand, the 399X is prepared to take it on. Separate yourself from the herd with a line of wheels that are 100% X-rayed on the production line to ensure quality and reliability. Center caps are included with each wheel (replacement center caps 0223-0186), but lug nuts must be ordered separately.

FITS MODEL	POSITION	SIZE	BOLT PATTERN	OFFSET	WHEEL PART #	LUG NUT CHROME (16-PK) PART #	LUG NUT BLACK (16-PK) PART #
399X WHEELS							
CAN-AM							
OUTLANDER 330/400/500/570/650/800/850/1000 03-19	FRONT	12X7	4/136	4+3	0230-0916	0232-0203	0232-0204
	REAR	12X8	4/136	4+4	0230-0919	0232-0203	0232-0204
	FRONT	14X7	4/136	4+3	0230-0922	0232-0203	0232-0204
	REAR	14X8	4/136	4+4	0230-0925	0232-0203	0232-0204
RENEGADE 500/570/800/850/1000 09-19	FRONT	12X7	4/136	4+3	0230-0916	0232-0203	0232-0204
	REAR	12X8	4/136	4+4	0230-0919	0232-0203	0232-0204
	FRONT	14X7	4/136	4+3	0230-0922	0232-0203	0232-0204
	REAR	14X8	4/136	4+4	0230-0925	0232-0203	0232-0204
MAVERICK/MAX 1000 14-19	FRONT	12X7	4/136	4+3	0230-0916	0232-0203	0232-0204
	REAR	12X8	4/136	4+4	0230-0919	0232-0203	0232-0204
	FRONT	14X7	4/136	4+3	0230-0922	0232-0203	0232-0204
	REAR	14X8	4/136	4+4	0230-0925	0232-0203	0232-0204
COMMANDER 800/1000 13-19	FRONT	12X7	4/136	4+3	0230-0916	0232-0203	0232-0204
	REAR	12X8	4/136	4+4	0230-0919	0232-0203	0232-0204
	FRONT	14X7	4/136	4+3	0230-0922	0232-0203	0232-0204
	REAR	14X8	4/136	4+4	0230-0925	0232-0203	0232-0204
DEFENDER 16-19	FRONT	12X7	4/136	4+3	0230-0916	0232-0203	0232-0204
	REAR	12X8	4/136	4+4	0230-0919	0232-0203	0232-0204
	FRONT	14X7	4/136	4+3	0230-0922	0232-0203	0232-0204
	REAR	14X8	4/136	4+4	0230-0925	0232-0203	0232-0204
HONDA							
TRX420AT/500AT (IRS) RANCHER 09-19	FRONT	12X7	4/110	4+3	0230-0917	0232-0203	0232-0204
	REAR	12X8	4/110	4+4	0230-0920	0232-0203	0232-0204
	FRONT	14X7	4/110	4+3	0230-0923	0232-0203	0232-0204
	REAR	14X8	4/110	4+4	0230-0926	0232-0203	0232-0204
TRX650/680/700 RINCON 4X4 02-19 (IRS)	FRONT	12X7	4/110	4+3	0230-0917	0232-0203	0232-0204
	REAR	12X8	4/110	4+4	0230-0920	0232-0203	0232-0204
	FRONT	14X7	4/110	4+3	0230-0923	0232-0203	0232-0204
	REAR	14X8	4/110	4+4	0230-0926	0232-0203	0232-0204
TRX500 FOREMAN RUBICON 15-19 (IRS)	FRONT	12X7	4/110	4+3	0230-0917	0232-0203	0232-0204
	REAR	12X8	4/110	4+4	0230-0920	0232-0203	0232-0204
	FRONT	14X7	4/110	4+3	0230-0923	0232-0203	0232-0204
	REAR	14X8	4/110	4+4	0230-0926	0232-0203	0232-0204
BIG RED 700 MUV 09-13	FRONT	12X7	4/110	4+3	0230-0917	0232-0209	-
	REAR	12X8	4/110	4+4	0230-0920	0232-0209	-
	FRONT	14X7	4/110	4+3	0230-0923	0232-0209	-
	REAR	14X8	4/110	4+4	0230-0926	0232-0209	-
PIONEER 500/700 14-19	FRONT	12X7	4/110	4+3	0230-0917	0232-0209	-
	REAR	12X8	4/110	4+4	0230-0920	0232-0209	-
	FRONT	14X7	4/110	4+3	0230-0923	0232-0209	-
	REAR	14X8	4/110	4+4	0230-0926	0232-0209	-

WHEELS & TIRES

FITS MODEL	POSITION	SIZE	BOLT PATTERN	OFFSET	WHEEL PART #	LUG NUT CHROME (16-PK) PART #	LUG NUT BLACK (16-PK) PART #
399X WHEELS (CON'T)							
HONDA (CON'T)							
PIONEER 1000 16-19	FRONT	12X7	4/136	4+3	0230-0916	0232-0209	-
	REAR	12X8	4/136	4+4	0230-0919	0232-0209	-
	FRONT	14X7	4/136	4+3	0230-0922	0232-0209	-
	REAR	14X8	4/136	4+4	0230-0925	0232-0209	-
KAWASAKI							
BRUTE FORCE 650I 4X4 06-18 (IRS)	FRONT	12X7	4/110	4+3	0230-0917	0232-0203	0232-0204
	REAR	12X8	4/110	4+4	0230-0920	0232-0203	0232-0204
	FRONT	14X7	4/110	4+3	0230-0923	0232-0203	0232-0204
	REAR	14X8	4/110	4+4	0230-0926	0232-0203	0232-0204
BRUTE FORCE 750 4X4 05-19 (IRS)	FRONT	12X7	4/110	4+3	0230-0917	0232-0203	0232-0204
	REAR	12X8	4/110	4+4	0230-0920	0232-0203	0232-0204
	FRONT	14X7	4/110	4+3	0230-0923	0232-0203	0232-0204
	REAR	14X8	4/110	4+4	0230-0926	0232-0203	0232-0204
TERYX 750/800 08-19	FRONT	12X7	4/136	4+3	0230-0916	0232-0207	0232-0208
	REAR	12X8	4/136	4+4	0230-0919	0232-0207	0232-0208
	FRONT	14X7	4/136	4+3	0230-0922	0232-0207	0232-0208
	REAR	14X8	4/136	4+4	0230-0925	0232-0207	0232-0208
MULE 2500/3000/4010 SERIES * LIFT KIT NEEDED FOR 66 CM (26") OR LARGER TIRES	FRONT	12X7	4/136	4+3	0230-0916	0232-0207	0232-0208
	REAR	12X8	4/136	4+4	0230-0919	0232-0207	0232-0208
	FRONT	14X7	4/136	4+3	0230-0922	0232-0207	0232-0208
	REAR	14X8	4/136	4+4	0230-0925	0232-0207	0232-0208
MULE PRO FXT 15-19	FRONT	12X7	4/156	4+3	0230-0915	0232-0207	0232-0208
	REAR	12X8	4/156	4+4	0230-0918	0232-0207	0232-0208
	FRONT	14X7	4/156	4+3	0230-0921	0232-0207	0232-0208
	REAR	14X8	4/156	4+4	0230-0924	0232-0207	0232-0208
KYMCO							
500MUX SA 08-10/MXU IE 08-18 450/500/700UXV 08-18	FRONT	12X7	4/110	4+3	0230-0917	0232-0203	0232-0204
	REAR	12X8	4/110	4+4	0230-0920	0232-0203	0232-0204
	FRONT	14X7	4/110	4+3	0230-0923	0232-0203	0232-0204
	REAR	14X8	4/110	4+4	0230-0926	0232-0203	0232-0204
POLARIS							
SPORTSMAN 335 99-06	FRONT	12X7	4/156	4+3	0230-0915	0232-0205	0232-0206
	REAR	12X8	4/156	4+4	0230-0918	0232-0205	0232-0206
	FRONT	14X7	4/156	4+3	0230-0921	0232-0205	0232-0206
	REAR	14X8	4/156	4+4	0230-0924	0232-0205	0232-0206
SPORTSMAN 400/450 01-13	FRONT	12X7	4/156	4+3	0230-0915	0232-0205	0232-0206
	REAR	12X8	4/156	4+4	0230-0918	0232-0205	0232-0206
	FRONT	14X7	4/156	4+3	0230-0921	0232-0205	0232-0206
	REAR	14X8	4/156	4+4	0230-0924	0232-0205	0232-0206
SPORTSMAN 500 96-13	FRONT	12X7	4/156	4+3	0230-0915	0232-0205	0232-0206
	REAR	12X8	4/156	4+4	0230-0918	0232-0205	0232-0206
	FRONT	14X7	4/156	4+3	0230-0921	0232-0205	0232-0206
	REAR	14X8	4/156	4+4	0230-0924	0232-0205	0232-0206
MAGNUM 500 02-06	FRONT	12X7	4/156	4+3	0230-0915	0232-0205	0232-0206
	REAR	12X8	4/156	4+4	0230-0918	0232-0205	0232-0206
	FRONT	14X7	4/156	4+3	0230-0921	0232-0205	0232-0206
	REAR	14X8	4/156	4+4	0230-0924	0232-0205	0232-0206
SPORTSMAN 570 14-19	FRONT	12X7	4/156	4+3	0230-0915	0232-0205	0232-0206
	REAR	12X8	4/156	4+4	0230-0918	0232-0205	0232-0206
	FRONT	14X7	4/156	4+3	0230-0921	0232-0205	0232-0206
	REAR	14X8	4/156	4+4	0230-0924	0232-0205	0232-0206
SPORTSMAN 600 03-09	FRONT	12X7	4/156	4+3	0230-0915	0232-0205	0232-0206
	REAR	12X8	4/156	4+4	0230-0918	0232-0205	0232-0206
	FRONT	14X7	4/156	4+3	0230-0921	0232-0205	0232-0206
	REAR	14X8	4/156	4+4	0230-0924	0232-0205	0232-0206
SPORTSMAN 700 02-09	FRONT	12X7	4/156	4+3	0230-0915	0232-0205	0232-0206
	REAR	12X8	4/156	4+4	0230-0918	0232-0205	0232-0206
	FRONT	14X7	4/156	4+3	0230-0921	0232-0205	0232-0206
	REAR	14X8	4/156	4+4	0230-0924	0232-0205	0232-0206
SPORTSMAN 800 05-14	FRONT	12X7	4/156	4+3	0230-0915	0232-0205	0232-0206
	REAR	12X8	4/156	4+4	0230-0918	0232-0205	0232-0206
	FRONT	14X7	4/156	4+3	0230-0921	0232-0205	0232-0206
	REAR	14X8	4/156	4+4	0230-0924	0232-0205	0232-0206
SPORTSMAN XP 550/700/800/850 09-19 * SPORTSMAN XP 2009 IS 12.5 CM (5") WIDER WITH AFTER MARKET WHEELS	FRONT	12X7	4/156	4+3	0230-0915	0232-0203	0232-0204
	REAR	12X8	4/156	4+4	0230-0918	0232-0203	0232-0204
	FRONT	14X7	4/156	4+3	0230-0921	0232-0203	0232-0204
	REAR	14X8	4/156	4+4	0230-0924	0232-0203	0232-0204
SPORTSMAN X2 500/550/800 09-15	FRONT	12X7	4/156	4+3	0230-0915	0232-0205	0232-0206
	REAR	12X8	4/156	4+4	0230-0918	0232-0205	0232-0206
	FRONT	14X7	4/156	4+3	0230-0921	0232-0205	0232-0206
	REAR	14X8	4/156	4+4	0230-0924	0232-0205	0232-0206
SPORTSMAN ACE 570/900 14-19	FRONT	12X7	4/156	4+3	0230-0915	0232-0205	0232-0206
	REAR	12X8	4/156	4+4	0230-0918	0232-0205	0232-0206

FITS MODEL	POSITION	SIZE	BOLT PATTERN	OFFSET	WHEEL PART #	LUG NUT CHROME (16-PK) PART #	LUG NUT BLACK (16-PK) PART #
399X WHEELS (CON'T)							
POLARIS (CON'T)							
SPORTSMAN ACE 570/900 14-19 (CON'T)	FRONT	14X7	4/156	4+3	0230-0921	0232-0205	0232-0206
	REAR	14X8	4/156	4+4	0230-0924	0232-0205	0232-0206
RANGER ETX/570/EV/ 800 6X6 4X4 03-19	FRONT	12X7	4/156	4+3	0230-0915	0232-0205	0232-0206
	REAR	12X8	4/156	4+4	0230-0918	0232-0205	0232-0206
	FRONT	14X7	4/156	4+3	0230-0921	0232-0205	0232-0206
	REAR	14X8	4/156	4+4	0230-0924	0232-0205	0232-0206
RANGER 570 (FULLSIZE) 14-19	FRONT	12X7	4/156	4+3	0230-0915	0232-0209	-
	REAR	12X8	4/156	4+4	0230-0918	0232-0209	-
	FRONT	14X7	4/156	4+3	0230-0921	0232-0209	-
	REAR	14X8	4/156	4+4	0230-0924	0232-0209	-
RANGER XP900 & DIESEL 14-19	FRONT	12X7	4/156	4+3	0230-0915	0232-0209	-
	REAR	12X8	4/156	4+4	0230-0918	0232-0209	-
	FRONT	14X7	4/156	4+3	0230-0921	0232-0209	-
	REAR	14X8	4/156	4+4	0230-0924	0232-0209	-
RZR 800/900XP 08-14 & RZR 570 14-19	FRONT	12X7	4/156	4+3	0230-0915	0232-0205	0232-0206
	REAR	12X8	4/156	4+4	0230-0918	0232-0205	0232-0206
	FRONT	14X7	4/156	4+3	0230-0921	0232-0205	0232-0206
	REAR	14X8	4/156	4+4	0230-0924	0232-0205	0232-0206
RZR 900/900 XC/900 S 15-19	FRONT	12X7	4/156	4+3	0230-0915	0232-0209	-
	REAR	12X8	4/156	4+4	0230-0918	0232-0209	-
	FRONT	14X7	4/156	4+3	0230-0921	0232-0209	-
	REAR	14X8	4/156	4+4	0230-0924	0232-0209	-
RZR 1000 XP / 4 14-17-19	FRONT	12X7	4/156	4+3	0230-0915	0232-0209	-
	REAR	12X8	4/156	4+4	0230-0918	0232-0209	-
	FRONT	14X7	4/156	4+3	0230-0921	0232-0209	-
	REAR	14X8	4/156	4+4	0230-0924	0232-0209	-
GENERAL 17-19	FRONT	12X7	4/156	4+3	0230-0915	0232-0209	-
	REAR	12X8	4/156	4+4	0230-0918	0232-0209	-
	FRONT	14X7	4/156	4+3	0230-0921	0232-0209	-
	REAR	14X8	4/156	4+4	0230-0924	0232-0209	-
SUZUKI							
KING QUAD 450/700/750 05-19 (IRS)	FRONT	12X7	4/110	4+3	0230-0917	0232-0203	0232-0204
	REAR	12X8	4/110	4+4	0230-0920	0232-0203	0232-0204
	FRONT	14X7	4/110	4+3	0230-0923	0232-0203	0232-0204
	REAR	14X8	4/110	4+4	0230-0926	0232-0203	0232-0204
YAMAHA							
GRIZZLY 350 IRS 07-15	FRONT	12X7	4/110	4+3	0230-0917	0232-0203	0232-0204
	REAR	12X8	4/110	4+4	0230-0920	0232-0203	0232-0204
	FRONT	14X7	4/110	4+3	0230-0923	0232-0203	0232-0204
	REAR	14X8	4/110	4+4	0230-0926	0232-0203	0232-0204
KODIAK 400/450 4X4 05-06 (IRS)	FRONT	12X7	4/110	4+3	0230-0917	0232-0203	0232-0204
	REAR	12X8	4/110	4+4	0230-0920	0232-0203	0232-0204
	FRONT	14X7	4/110	4+3	0230-0923	0232-0203	0232-0204
	REAR	14X8	4/110	4+4	0230-0926	0232-0203	0232-0204
GRIZZLY 400/450/550/700 IRS 4X4 07-19	FRONT	12X7	4/110	4+3	0230-0917	0232-0203	0232-0204
	REAR	12X8	4/110	4+4	0230-0920	0232-0203	0232-0204
	FRONT	14X7	4/110	4+3	0230-0923	0232-0203	0232-0204
	REAR	14X8	4/110	4+4	0230-0926	0232-0203	0232-0204
BIG BEAR 400 IRS 07-11	FRONT	12X7	4/110	4+3	0230-0917	0232-0203	0232-0204
	REAR	12X8	4/110	4+4	0230-0920	0232-0203	0232-0204
	FRONT	14X7	4/110	4+3	0230-0923	0232-0203	0232-0204
	REAR	14X8	4/110	4+4	0230-0926	0232-0203	0232-0204
GRIZZLY 660 02-09	FRONT	12X7	4/110	4+3	0230-0917	0232-0203	0232-0204
	REAR	12X8	4/110	4+4	0230-0920	0232-0203	0232-0204
	FRONT	14X7	4/110	4+3	0230-0923	0232-0203	0232-0204
	REAR	14X8	4/110	4+4	0230-0926	0232-0203	0232-0204
KODIAK 700 16-19	FRONT	12X7	4/110	4+3	0230-0917	0232-0203	0232-0204
	REAR	12X8	4/110	4+4	0230-0920	0232-0203	0232-0204
	FRONT	14X7	4/110	4+3	0230-0923	0232-0203	0232-0204
	REAR	14X8	4/110	4+4	0230-0926	0232-0203	0232-0204
RHINO 450/660/700 04-13	FRONT	12X7	4/110	4+3	0230-0917	0232-0203	0232-0204
	REAR	12X8	4/110	4+4	0230-0920	0232-0203	0232-0204
	FRONT	14X7	4/110	4+3	0230-0923	0232-0203	0232-0204
	REAR	14X8	4/110	4+4	0230-0926	0232-0203	0232-0204
VIKING 14-19	FRONT	12X7	4/110	4+3	0230-0917	0232-0207	0232-0208
	REAR	12X8	4/110	4+4	0230-0920	0232-0207	0232-0208
	FRONT	14X7	4/110	4+3	0230-0923	0232-0207	0232-0208
	REAR	14X8	4/110	4+4	0230-0926	0232-0207	0232-0208
WOLVERINE16-19	FRONT	12X7	4/110	4+3	0230-0917	0232-0207	0232-0208
	REAR	12X8	4/110	4+4	0230-0920	0232-0207	0232-0208
	FRONT	14X7	4/110	4+3	0230-0923	0232-0207	0232-0208
	REAR	14X8	4/110	4+4	0230-0926	0232-0207	0232-0208
YZX 1000R 16-18	FRONT	14X7	4/110	4+3	0230-0923	0232-0207	0232-0208
	REAR	14X8	4/110	4+4	0230-0926	0232-0207	0232-0208





547X™

547X ATV/UTV WHEELS

Whether it's in the woods, deep mud or sand, the 547X is prepared to take it on. Handles load capacities from 675 lbs. for the 12x7, and 14x7 fronts to 1150 lbs. for the 12x8 and 14x8 rear which meet, or exceed all current market requirements. Separate yourself from the herd with a line of wheels that are 100% x-rayed on the production line to ensure quality and reliability. Center caps are included with each wheel, but lug nuts must be ordered separately.

FITS MODEL	POSITION	SIZE	BOLT PATTERN	OFFSET	WHEEL PART #	LUG NUT CHROME (16-PK) PART #	LUG NUT BLACK (16-PK) PART #
547X WHEELS							
ARCTIC CAT							
250/300 2X4/4X4 98-02,							
300/400/500/650/700/1000 2X4/4X4 02-19	FRONT	12X7	4/115	4+3	0230-0895	0232-0203	0232-0204
	REAR	12X8	4/115	4+4	0230-0899	0232-0203	0232-0204
	FRONT	14X7	4/115	4+3	0230-0903	0232-0203	0232-0204
	REAR	14X8	4/115	4+4	0230-0907	0232-0203	0232-0204
CAN-AM							
OUTLANDER 330/400/500/570/650/800/850/1000 03-19	FRONT	12X7	4/136	4+3	0230-0894	0232-0203	0232-0204
	REAR	12X8	4/136	4+4	0230-0898	0232-0203	0232-0204
	FRONT	14X7	4/136	4+3	0230-0902	0232-0203	0232-0204
	REAR	14X8	4/136	4+4	0230-0906	0232-0203	0232-0204
RENEGADE 500/570/800/850/1000 09-19	FRONT	12X7	4/136	4+3	0230-0894	0232-0203	0232-0204
	REAR	12X8	4/136	4+4	0230-0898	0232-0203	0232-0204
	FRONT	14X7	4/136	4+3	0230-0902	0232-0203	0232-0204
	REAR	14X8	4/136	4+4	0230-0906	0232-0203	0232-0204
MAVERICK/MAX 1000 14-19	FRONT	12X7	4/136	4+3	0230-0894	0232-0203	0232-0204
	REAR	12X8	4/136	4+4	0230-0898	0232-0203	0232-0204
	FRONT	14X7	4/136	4+3	0230-0902	0232-0203	0232-0204
	REAR	14X8	4/136	4+4	0230-0906	0232-0203	0232-0204
COMMANDER 800/1000 13-19	FRONT	12X7	4/136	4+3	0230-0894	0232-0203	0232-0204
	REAR	12X8	4/136	4+4	0230-0898	0232-0203	0232-0204
	FRONT	14X7	4/136	4+3	0230-0902	0232-0203	0232-0204
	REAR	14X8	4/136	4+4	0230-0906	0232-0203	0232-0204
DEFENDER 16-19	FRONT	12X7	4/136	4+3	0230-0894	0232-0203	0232-0204
	REAR	12X8	4/136	4+4	0230-0898	0232-0203	0232-0204
	FRONT	14X7	4/136	4+3	0230-0902	0232-0203	0232-0204
	REAR	14X8	4/136	4+4	0230-0906	0232-0203	0232-0204
HONDA							
TRX650/680 RINCON 4X4 02-19 (IRS)	FRONT	12X7	4/110	4+3	0230-0893	0232-0203	0232-0204
	REAR	12X8	4/110	4+4	0230-0897	0232-0203	0232-0204
	FRONT	14X7	4/110	4+3	0230-0901	0232-0203	0232-0204
	REAR	14X8	4/110	4+4	0230-0905	0232-0203	0232-0204
TRX420AT/500AT (IRS) RANCHER 09-19	FRONT	12X7	4/110	4+3	0230-0893	0232-0203	0232-0204
	REAR	12X8	4/110	4+4	0230-0897	0232-0203	0232-0204
	FRONT	14X7	4/110	4+3	0230-0901	0232-0203	0232-0204
	REAR	14X8	4/110	4+4	0230-0905	0232-0203	0232-0204
TRX500 FOREMAN RUBICON 15-19 (IRS)	FRONT	12X7	4/110	4+3	0230-0893	0232-0203	0232-0204
	REAR	12X8	4/110	4+4	0230-0897	0232-0203	0232-0204
	FRONT	14X7	4/110	4+3	0230-0901	0232-0203	0232-0204
	REAR	14X8	4/110	4+4	0230-0905	0232-0203	0232-0204
BIG RED 700 MUV 09-13	FRONT	12X7	4/110	4+3	0230-0893	0232-0209	-
	REAR	12X8	4/110	4+4	0230-0897	0232-0209	-
	FRONT	14X7	4/110	4+3	0230-0901	0232-0209	-
	REAR	14X8	4/110	4+4	0230-0905	0232-0209	-

WHEELS & TIRES

FITS MODEL	POSITION	SIZE	BOLT PATTERN	OFFSET	WHEEL PART #	LUG NUT CHROME (16-PK) PART #	LUG NUT BLACK (16-PK) PART #
547X WHEELS (CON'T)							
HONDA (CON'T)							
PIONEER 500/700 14-19	FRONT	12X7	4/110	4+3	0230-0893	0232-0209	-
	REAR	12X8	4/110	4+4	0230-0897	0232-0209	-
	FRONT	14X7	4/110	4+3	0230-0901	0232-0209	-
	REAR	14X8	4/110	4+4	0230-0905	0232-0209	-
PIONEER 1000 16-19	FRONT	12X7	4/136	4+3	0230-0894	0232-0209	-
	REAR	12X8	4/136	4+4	0230-0898	0232-0209	-
	FRONT	14X7	4/136	4+3	0230-0902	0232-0209	-
	REAR	14X8	4/136	4+4	0230-0906	0232-0209	-
KAWASAKI							
BRUTE FORCE 650I 4X4 06-18 (IRS)	FRONT	12X7	4/110	4+3	0230-0893	0232-0203	0232-0204
	REAR	12X8	4/110	4+4	0230-0897	0232-0203	0232-0204
	FRONT	14X7	4/110	4+3	0230-0901	0232-0203	0232-0204
	REAR	14X8	4/110	4+4	0230-0905	0232-0203	0232-0204
BRUTE FORCE 750 4X4 05-19 (IRS)	FRONT	12X7	4/110	4+3	0230-0893	0232-0203	0232-0204
	REAR	12X8	4/110	4+4	0230-0897	0232-0203	0232-0204
	FRONT	14X7	4/110	4+3	0230-0901	0232-0203	0232-0204
	REAR	14X8	4/110	4+4	0230-0905	0232-0203	0232-0204
TERYX 750/800 08-19	FRONT	12X7	4/136	4+3	0230-0894	0232-0207	0232-0208
	REAR	12X8	4/136	4+4	0230-0898	0232-0207	0232-0208
	FRONT	14X7	4/136	4+3	0230-0902	0232-0207	0232-0208
	REAR	14X8	4/136	4+4	0230-0906	0232-0207	0232-0208
MULE 2500/3000/4010 SERIES * LIFT KIT NEEDED FOR 66 CM (26") OR LARGER TIRES	FRONT	12X7	4/136	4+3	0230-0894	0232-0207	0232-0208
	REAR	12X8	4/136	4+4	0230-0898	0232-0207	0232-0208
	FRONT	14X7	4/136	4+3	0230-0902	0232-0207	0232-0208
	REAR	14X8	4/136	4+4	0230-0906	0232-0207	0232-0208
MULE PRO FXT 15-19	FRONT	12X7	4/156	4+3	0230-0892	0232-0207	0232-0208
	REAR	12X8	4/156	4+4	0230-0896	0232-0207	0232-0208
	FRONT	14X7	4/156	4+3	0230-0900	0232-0207	0232-0208
	REAR	14X8	4/156	4+4	0230-0904	0232-0207	0232-0208
KYMCO							
500MUX SA 08-10/MXU IE 375/500/700 08-18 450/500/700UXV 08-18	FRONT	12X7	4/110	4+3	0230-0893	0232-0203	0232-0204
	REAR	12X8	4/110	4+4	0230-0897	0232-0203	0232-0204
	FRONT	14X7	4/110	4+3	0230-0901	0232-0203	0232-0204
	REAR	14X8	4/110	4+4	0230-0905	0232-0203	0232-0204
POLARIS							
SPORTSMAN 335 99-06	FRONT	12X7	4/156	4+3	0230-0892	0232-0205	0232-0206
	REAR	12X8	4/156	4+4	0230-0896	0232-0205	0232-0206
	FRONT	14X7	4/156	4+3	0230-0900	0232-0205	0232-0206
	REAR	14X8	4/156	4+4	0230-0904	0232-0205	0232-0206
SPORTSMAN 400/450 01-16	FRONT	12X7	4/156	4+3	0230-0892	0232-0205	0232-0206
	REAR	12X8	4/156	4+4	0230-0896	0232-0205	0232-0206
	FRONT	14X7	4/156	4+3	0230-0900	0232-0205	0232-0206
	REAR	14X8	4/156	4+4	0230-0904	0232-0205	0232-0206
SPORTSMAN 500 96-13	FRONT	12X7	4/156	4+3	0230-0892	0232-0205	0232-0206
	REAR	12X8	4/156	4+4	0230-0896	0232-0205	0232-0206
	FRONT	14X7	4/156	4+3	0230-0900	0232-0205	0232-0206
	REAR	14X8	4/156	4+4	0230-0904	0232-0205	0232-0206
MAGNUM 500 02-06	FRONT	12X7	4/156	4+3	0230-0892	0232-0205	0232-0206
	REAR	12X8	4/156	4+4	0230-0896	0232-0205	0232-0206
	FRONT	14X7	4/156	4+3	0230-0900	0232-0205	0232-0206
	REAR	14X8	4/156	4+4	0230-0904	0232-0205	0232-0206
SPORTSMAN 570 14-19	FRONT	12X7	4/156	4+3	0230-0892	0232-0205	0232-0206
	REAR	12X8	4/156	4+4	0230-0896	0232-0205	0232-0206
	FRONT	14X7	4/156	4+3	0230-0900	0232-0205	0232-0206
	REAR	14X8	4/156	4+4	0230-0904	0232-0205	0232-0206
SPORTSMAN 600 03-09	FRONT	12X7	4/156	4+3	0230-0892	0232-0205	0232-0206
	REAR	12X8	4/156	4+4	0230-0896	0232-0205	0232-0206
	FRONT	14X7	4/156	4+3	0230-0900	0232-0205	0232-0206
	REAR	14X8	4/156	4+4	0230-0904	0232-0205	0232-0206
SPORTSMAN 700 02-09	FRONT	12X7	4/156	4+3	0230-0892	0232-0205	0232-0206
	REAR	12X8	4/156	4+4	0230-0896	0232-0205	0232-0206
	FRONT	14X7	4/156	4+3	0230-0900	0232-0205	0232-0206
	REAR	14X8	4/156	4+4	0230-0904	0232-0205	0232-0206
SPORTSMAN 800 05-14	FRONT	12X7	4/156	4+3	0230-0892	0232-0205	0232-0206
	REAR	12X8	4/156	4+4	0230-0896	0232-0205	0232-0206
	FRONT	14X7	4/156	4+3	0230-0900	0232-0205	0232-0206
	REAR	14X8	4/156	4+4	0230-0904	0232-0205	0232-0206
SPORTSMAN XP 550/700/800/850/1000 09-19 * SPORTSMAN XP 2009 IS 12.5 CM (5") WIDER WITH AFTER MARKET WHEELS	FRONT	12X7	4/156	4+3	0230-0892	0232-0203	0232-0204
	REAR	12X8	4/156	4+4	0230-0896	0232-0203	0232-0204
	FRONT	14X7	4/156	4+3	0230-0900	0232-0203	0232-0204
	REAR	14X8	4/156	4+4	0230-0904	0232-0203	0232-0204
SPORTSMAN X2 500/550/800/1000 09-19	FRONT	12X7	4/156	4+3	0230-0892	0232-0205	0232-0206
	REAR	12X8	4/156	4+4	0230-0896	0232-0205	0232-0206

FITS MODEL	POSITION	SIZE	BOLT PATTERN	OFFSET	WHEEL PART #	LUG NUT CHROME (16-PK) PART #	LUG NUT BLACK (16-PK) PART #
547X WHEELS (CON'T)							
POLARIS (CON'T)							
SPORTSMAN X2 500/550/800/1000 09-19 (CON'T)	FRONT	14X7	4/156	4+3	0230-0900	0232-0205	0232-0206
	REAR	14X8	4/156	4+4	0230-0904	0232-0205	0232-0206
SPORTSMAN ACE 570/900 14-19	FRONT	12X7	4/156	4+3	0230-0892	0232-0205	0232-0206
	REAR	12X8	4/156	4+4	0230-0896	0232-0205	0232-0206
	FRONT	14X7	4/156	4+3	0230-0900	0232-0205	0232-0206
	REAR	14X8	4/156	4+4	0230-0904	0232-0205	0232-0206
RANGER ETX/570/EV/ 800 6X6 4X4 03-19	FRONT	12X7	4/156	4+3	0230-0892	0232-0205	0232-0206
	REAR	12X8	4/156	4+4	0230-0896	0232-0205	0232-0206
	FRONT	14X7	4/156	4+3	0230-0900	0232-0205	0232-0206
	REAR	14X8	4/156	4+4	0230-0904	0232-0205	0232-0206
RANGER 570 (FULLSIZE) 14-19	FRONT	12X7	4/156	4+3	0230-0892	0232-0209	-
	REAR	12X8	4/156	4+4	0230-0896	0232-0209	-
	FRONT	14X7	4/156	4+3	0230-0900	0232-0209	-
	REAR	14X8	4/156	4+4	0230-0904	0232-0209	-
RANGER XP900/1000 & DIESEL 14-19	FRONT	12X7	4/156	4+3	0230-0892	0232-0209	-
	REAR	12X8	4/156	4+4	0230-0896	0232-0209	-
	FRONT	14X7	4/156	4+3	0230-0900	0232-0209	-
	REAR	14X8	4/156	4+4	0230-0904	0232-0209	-
RZR 800/900XP 08-14 & RZR 570 14-19	FRONT	12X7	4/156	4+3	0230-0892	0232-0205	0232-0206
	REAR	12X8	4/156	4+4	0230-0896	0232-0205	0232-0206
	FRONT	14X7	4/156	4+3	0230-0900	0232-0205	0232-0206
	REAR	14X8	4/156	4+4	0230-0904	0232-0205	0232-0206
RZR 900/900 XC/900 S 15-19	FRONT	12X7	4/156	4+3	0230-0892	0232-0209	-
	REAR	12X8	4/156	4+4	0230-0896	0232-0209	-
	FRONT	14X7	4/156	4+3	0230-0900	0232-0209	-
	REAR	14X8	4/156	4+4	0230-0904	0232-0209	-
RZR 1000 XP / 4 14-19	FRONT	12X7	4/156	4+3	0230-0892	0232-0209	-
	REAR	12X8	4/156	4+4	0230-0896	0232-0209	-
	FRONT	14X7	4/156	4+3	0230-0900	0232-0209	-
	REAR	14X8	4/156	4+4	0230-0904	0232-0209	-
SUZUKI							
KING QUAD 450/700/750 05-19 (IRS)	FRONT	12X7	4/110	4+3	0230-0893	0232-0203	0232-0204
	REAR	12X8	4/110	4+4	0230-0897	0232-0203	0232-0204
	FRONT	14X7	4/110	4+3	0230-0901	0232-0203	0232-0204
	REAR	14X8	4/110	4+4	0230-0905	0232-0203	0232-0204
YAMAHA							
GRIZZLY 350 IRS 07-15	FRONT	12X7	4/110	4+3	0230-0893	0232-0203	0232-0204
	REAR	12X8	4/110	4+4	0230-0897	0232-0203	0232-0204
	FRONT	14X7	4/110	4+3	0230-0901	0232-0203	0232-0204
	REAR	14X8	4/110	4+4	0230-0905	0232-0203	0232-0204
KODIAK 400/450 4X4 05-06 (IRS)	FRONT	12X7	4/110	4+3	0230-0893	0232-0203	0232-0204
	REAR	12X8	4/110	4+4	0230-0897	0232-0203	0232-0204
	FRONT	14X7	4/110	4+3	0230-0901	0232-0203	0232-0204
	REAR	14X8	4/110	4+4	0230-0905	0232-0203	0232-0204
GRIZZLY 400/450/550/700 4X4 07-19	FRONT	12X7	4/110	4+3	0230-0893	0232-0203	0232-0204
	REAR	12X8	4/110	4+4	0230-0897	0232-0203	0232-0204
	FRONT	14X7	4/110	4+3	0230-0901	0232-0203	0232-0204
	REAR	14X8	4/110	4+4	0230-0905	0232-0203	0232-0204
BIG BEAR 400 IRS 07-11	FRONT	12X7	4/110	4+3	0230-0893	0232-0203	0232-0204
	REAR	12X8	4/110	4+4	0230-0897	0232-0203	0232-0204
	FRONT	14X7	4/110	4+3	0230-0901	0232-0203	0232-0204
	REAR	14X8	4/110	4+4	0230-0905	0232-0203	0232-0204
GRIZZLY 660 02-09	FRONT	12X7	4/110	4+3	0230-0893	0232-0203	0232-0204
	REAR	12X8	4/110	4+4	0230-0897	0232-0203	0232-0204
	FRONT	14X7	4/110	4+3	0230-0901	0232-0203	0232-0204
	REAR	14X8	4/110	4+4	0230-0905	0232-0203	0232-0204
KODIAK 700 18-19	FRONT	12X7	4/110	4+3	0230-0893	0232-0203	0232-0204
	REAR	12X8	4/110	4+4	0230-0897	0232-0203	0232-0204
	FRONT	14X7	4/110	4+3	0230-0901	0232-0203	0232-0204
	REAR	14X8	4/110	4+4	0230-0905	0232-0203	0232-0204
RHINO 450/660/700 04-13	FRONT	12X7	4/110	4+3	0230-0893	0232-0203	0232-0204
	REAR	12X8	4/110	4+4	0230-0897	0232-0203	0232-0204
	FRONT	14X7	4/110	4+3	0230-0901	0232-0203	0232-0204
	REAR	14X8	4/110	4+4	0230-0905	0232-0203	0232-0204
VIKING 14-19	FRONT	12X7	4/110	4+3	0230-0893	0232-0207	0232-0208
	REAR	12X8	4/110	4+4	0230-0897	0232-0207	0232-0208
	FRONT	14X7	4/110	4+3	0230-0901	0232-0207	0232-0208
	REAR	14X8	4/110	4+4	0230-0905	0232-0207	0232-0208
WOLVERINE16-19	FRONT	12X7	4/110	4+3	0230-0893	0232-0207	0232-0208
	REAR	12X8	4/110	4+4	0230-0897	0232-0207	0232-0208
	FRONT	14X7	4/110	4+3	0230-0901	0232-0207	0232-0208
	REAR	14X8	4/110	4+4	0230-0905	0232-0207	0232-0208
YXZ 1000R 16-18	FRONT	14X7	4/110	4+3	0230-0901	0232-0207	0232-0208
	REAR	14X8	4/110	4+4	0230-0905	0232-0207	0232-0208



BLACK



MACHINED W/ BLACK

420X™

420X UTV WHEELS

The 17x7 size is built to handle the larger 43 cm (17") tires on the market for UTVs. Rated for 1300 lbs. load rating and is tested to DOT standards. 100% of the wheels are X-rayed on the line to assure you are getting the highest-quality wheel on the market. Available in gloss black or gloss black machined lip. Center caps are included with each wheel, but lug nuts must be ordered separately.

FITS MODEL	POSITION	SIZE	BOLT PATTERN	OFFSET	MACHINED W/ BLACK WHEEL PART #	BLACK WHEEL PART #	LUG NUT CHROME (16-PK) PART #	LUG NUT BLACK (16-PK) PART #
ARCTIC CAT								
PROWLER 07-19	FRONT/REAR	17X7	4/115	4 + 3	0230-0846	0230-0842	0232-0203	0232-0204
WILD CAT 13-19	FRONT/REAR	17X7	4/115	4 + 3	0230-0846	0230-0842	0232-0203	0232-0204
CAN-AM								
MAVERICK/MAX 1000 14-19	FRONT/REAR	17X7	4/136	4 + 3	0230-0847	0230-0843	0232-0203	0232-0204
COMMANDER 800/1000 13-19	FRONT/REAR	17X7	4/136	4 + 3	0230-0847	0230-0843	0232-0203	0232-0204
DEFENDER 16-19	FRONT/REAR	17X7	4/136	4 + 3	0230-0847	0230-0843	0232-0203	0232-0204
HONDA								
BIG RED 700 MUV 09-13	FRONT/REAR	17X7	4/110	4 + 3	0230-0845	0230-0841	0232-0209	-
PIONEER 500/700 14-19	FRONT/REAR	17X7	4/110	4 + 3	0230-0845	0230-0841	0232-0209	-
PIONEER 1000 16-19	FRONT/REAR	17X7	4/136	4 + 3	0230-0847	0230-0843	0232-0209	-
KAWASAKI								
TERYX 750/800 08-19	FRONT/REAR	17X7	4/136	4 + 3	0230-0847	0230-0843	0232-0207	0232-0208
POLARIS								
RANGER ETX/570/EV/ 800 6X6 4X4 03-19	FRONT/REAR	17X7	4/156	4 + 3	0230-0848	0230-0844	0232-0205	0232-0206
RANGER XP900 & DIESEL 14-19	FRONT/REAR	17X7	4/156	4 + 3	0230-0848	0230-0844	0232-0209	-
GENERAL 17-19	FRONT/REAR	17X7	4/156	4 + 3	0230-0848	0230-0844	0232-0205	0232-0206
RZR 800/900XP 08-14 & RZR 570 14-19	FRONT/REAR	17X7	4/156	4 + 3	0230-0848	0230-0844	0232-0205	0232-0206
RZR 900/900 XC/900 S 15-19	FRONT/REAR	17X7	4/156	4 + 3	0230-0848	0230-0844	0232-0209	-
RZR 1000 XP / 4 14-19	FRONT/REAR	17X7	4/156	4 + 3	0230-0848	0230-0844	0232-0209	-
YAMAHA								
RHINO 450/660/700 04-13	FRONT/REAR	17X7	4/110	4 + 3	0230-0845	0230-0841	0232-0203	0232-0204
VIKING 700 14-19	FRONT/REAR	17X7	4/110	4 + 3	0230-0845	0230-0841	0232-0207	0232-0208
WOLVERINE 16-19	FRONT/REAR	17X7	4/110	4 + 3	0230-0845	0230-0841	0232-0207	0232-0208
YZZ 1000R 16-18	FRONT/REAR	17X7	4/110	4 + 3	0230-0845	0230-0841	0232-0207	0232-0208



PLOWS

WINCHES

UTV

RACKS

IMPLEMENTS
& TOWING

LUGGAGE

BODY

CONTROLS

ELECTRICAL

WHEELS
& TIRES

SUSPENSION
& DRIVE

BRAKING

ENGINE

RIDER

GARAGE

PROMO

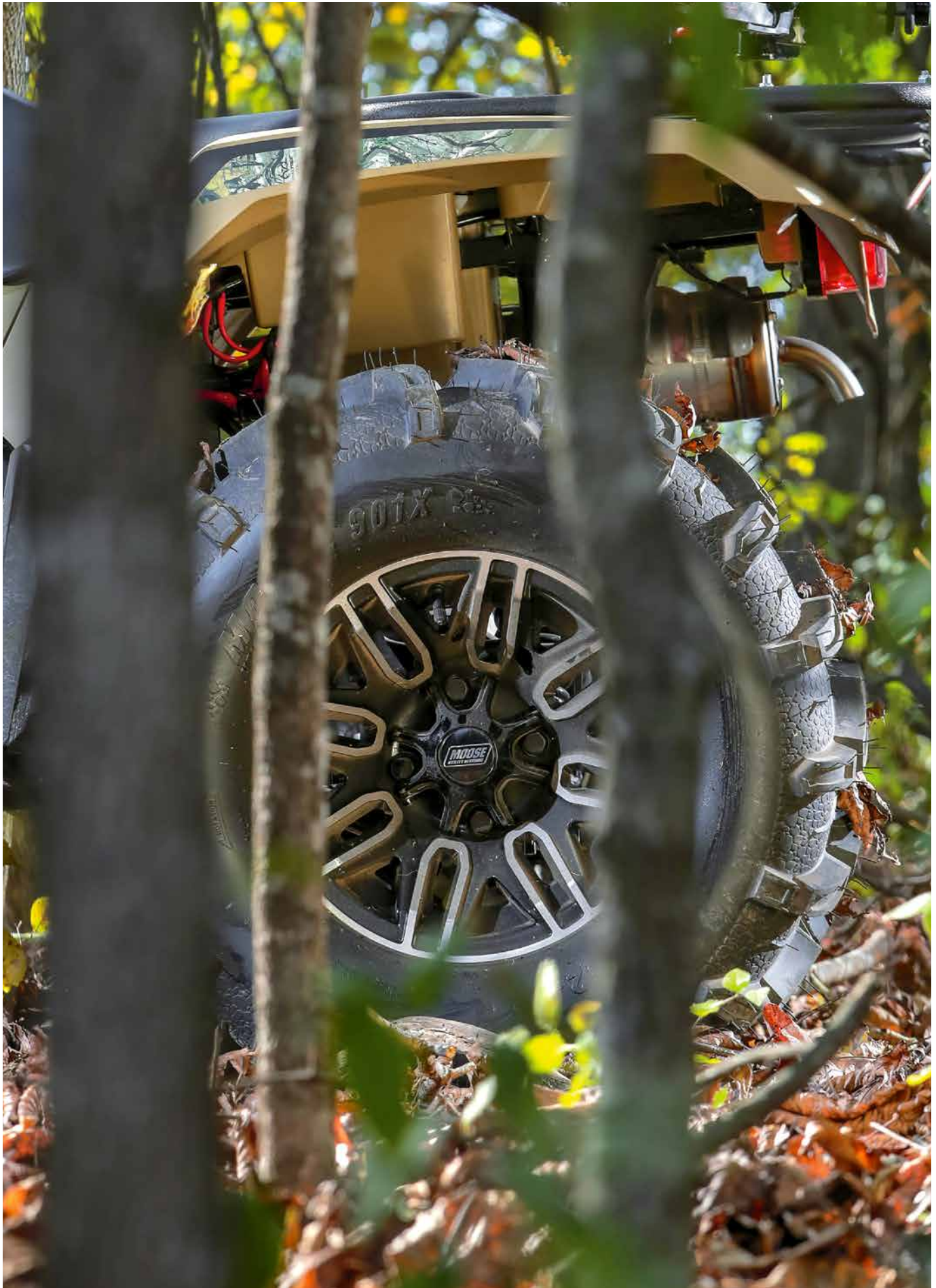



112X™

112X ATV/UTV WHEELS

Whether it's in the woods, deep mud or sand, the 112X is prepared to take it on. Handles load capacities from 675 lbs. for the 12x7, and 14x7 fronts to 1150 lbs. for the 12x8 and 14x8 rear which meet, or exceed all current market requirements. Separate yourself from the herd with a line of wheels that are 100% x-rayed on the production line to ensure quality and reliability. Center caps are included with each wheel (replacement center caps 0223-0169), but lug nuts must be ordered separately.

FITS MODEL	POSITION	SIZE	BOLT PATTERN	OFFSET	WHEEL PART #	LUG NUT CHROME (16-PK) PART #	LUG NUT BLACK (16-PK) PART #
112X ATV/UTV WHEELS							
CAN-AM							
OUTLANDER 330/400/500/570/650/800/850/1000 03-19	FRONT	12X7	4/136	4 + 3	0230-0872	0232-0203	0232-0204
	REAR	12X8	4/136	4 + 4	0230-0877	0232-0203	0232-0204
RENEGADE 500/570/800/850/1000 09-19	FRONT/REAR	14X7	4/136	4 + 3	0230-0881	0232-0203	0232-0204
	FRONT	12X7	4/136	4 + 3	0230-0872	0232-0203	0232-0204
REAR	12X8	4/136	4 + 4	0230-0877	0232-0203	0232-0204	
	FRONT/REAR	14X7	4/136	4 + 3	0230-0881	0232-0203	0232-0204
MAVERICK/MAX 1000 14-19	FRONT	12X7	4/136	4 + 3	0230-0872	0232-0203	0232-0204
	REAR	12X8	4/136	4 + 4	0230-0877	0232-0203	0232-0204
COMMANDER 800/1000 13-19	FRONT	14X7	4/136	4 + 3	0230-0881	0232-0203	0232-0204
	FRONT	12X7	4/136	4 + 3	0230-0872	0232-0203	0232-0204
REAR	12X8	4/136	4 + 4	0230-0877	0232-0203	0232-0204	
	FRONT/REAR	14X7	4/136	4 + 3	0230-0881	0232-0203	0232-0204
DEFENDER 16-19	FRONT	12X7	4/136	4 + 3	0230-0872	0232-0203	0232-0204
	REAR	12X8	4/136	4 + 4	0230-0877	0232-0203	0232-0204
FRONT/REAR	14X7	4/136	4 + 3	0230-0881	0232-0203	0232-0204	
HONDA							
TRX650/680 RINCON 4X4 02-19	FRONT	12X7	4/110	4 + 3	0230-0873	0232-0203	0232-0204
	REAR	12X8	4/110	4 + 4	0230-0878	0232-0203	0232-0204
FRONT	14X7	4/110	4 + 3	0230-0882	0232-0203	0232-0204	
	REAR	14X8	4/110	4 + 4	0230-0885	0232-0203	0232-0204
TRX420AT/500AT RANCHER 09-19	FRONT	12X7	4/110	4 + 3	0230-0873	0232-0203	0232-0204
	REAR	12X8	4/110	4 + 4	0230-0878	0232-0203	0232-0204
FRONT	14X7	4/110	4 + 3	0230-0882	0232-0203	0232-0204	
	REAR	14X8	4/110	4 + 4	0230-0885	0232-0203	0232-0204
BIG RED 700 MUV 09-13	FRONT	12X7	4/110	4 + 3	0230-0873	0232-0209	-
	REAR	12X8	4/110	4 + 4	0230-0878	0232-0209	-
FRONT	14X7	4/110	4 + 3	0230-0882	0232-0209	-	
	REAR	14X8	4/110	4 + 4	0230-0885	0232-0209	-
PIONEER 500/700 14-19	FRONT	12X7	4/110	4 + 3	0230-0873	0232-0209	-
	REAR	12X8	4/110	4 + 4	0230-0878	0232-0209	-
FRONT	14X7	4/110	4 + 3	0230-0882	0232-0209	-	
	REAR	14X8	4/110	4 + 4	0230-0885	0232-0209	-

WHEELS & TIRES

FITS MODEL	POSITION	SIZE	BOLT PATTERN	OFFSET	WHEEL PART #	LUG NUT CHROME (16-PK) PART #	LUG NUT BLACK (16-PK) PART #
112X ATV/UTV WHEELS (CON'T)							
HONDA (CON'T)							
PIONEER 1000 16-19	FRONT	12X7	4/136	4+3	0230-0872	0232-0209	-
	REAR	12X8	4/136	4+4	0230-0877	0232-0209	-
	FRONT/REAR	14X7	4/136	4+3	0230-0881	0232-0209	-
KAWASAKI							
BRUTE FORCE 650I 4X4 06-18 (IRS MODEL)	FRONT	12X7	4/110	4+3	0230-0873	0232-0203	0232-0204
	REAR	12X8	4/110	4+4	0230-0878	0232-0203	0232-0204
	FRONT	14X7	4/110	4+3	0230-0882	0232-0203	0232-0204
	REAR	14X8	4/110	4+4	0230-0885	0232-0203	0232-0204
BRUTE FORCE 750 4X4 05-19 (IRS)	FRONT	12X7	4/110	4+3	0230-0873	0232-0203	0232-0204
	REAR	12X8	4/110	4+4	0230-0878	0232-0203	0232-0204
	FRONT	14X7	4/110	4+3	0230-0882	0232-0203	0232-0204
	REAR	14X8	4/110	4+4	0230-0885	0232-0203	0232-0204
TERYX 750/800 08-19	FRONT	12X7	4/136	4+3	0230-0872	0232-0207	0232-0208
	REAR	12X8	4/136	4+4	0230-0877	0232-0207	0232-0208
	FRONT/REAR	14X7	4/136	4+3	0230-0881	0232-0207	0232-0208
MULE 2500/3000/4010 SERIES ALL	FRONT	12X7	4/136	4+3	0230-0872	0232-0207	0232-0208
* LIFT KIT NEEDED FOR 66 CM (26") OR LARGER TIRES	REAR	12X8	4/136	4+4	0230-0877	0232-0207	0232-0208
	FRONT/REAR	14X7	4/136	4+3	0230-0881	0232-0207	0232-0208
MULE PRO FXT/PRO 4 15-19	FRONT	12X7	4/156	4+3	0230-0871	0232-0207	0232-0208
	REAR	12X8	4/156	4+4	0230-0876	0232-0207	0232-0208
	FRONT	14X7	4/156	4+3	0230-0880	0232-0207	0232-0208
	REAR	14X8	4/156	4+4	0230-0883	0232-0207	0232-0208
KYMCO							
500MUX SA 08-10/MXU 1E 08-11/500 UXV 10-14	FRONT	12X7	4/110	4+3	0230-0873	0232-0203	0232-0204
	REAR	12X8	4/110	4+4	0230-0878	0232-0203	0232-0204
375/500/700 MUX-1E 08-18	FRONT	12X7	4/110	4+3	0230-0873	0232-0203	0232-0204
	REAR	12X8	4/110	4+4	0230-0878	0232-0203	0232-0204
450/500/700 UXV 08-18	FRONT	12X7	4/110	4+3	0230-0873	0232-0203	0232-0204
	REAR	12X8	4/110	4+4	0230-0878	0232-0203	0232-0204
POLARIS							
SPORTSMAN 335 99-06	FRONT	12X7	4/156	4+3	0230-0871	0232-0205	0232-0206
	REAR	12X8	4/156	4+4	0230-0876	0232-0205	0232-0206
	FRONT	14X7	4/156	4+3	0230-0880	0232-0205	0232-0206
	REAR	14X8	4/156	4+4	0230-0883	0232-0205	0232-0206
SPORTSMAN 400/450 01-13	FRONT	12X7	4/156	4+3	0230-0871	0232-0205	0232-0206
	REAR	12X8	4/156	4+4	0230-0876	0232-0205	0232-0206
	FRONT	14X7	4/156	4+3	0230-0880	0232-0205	0232-0206
	REAR	14X8	4/156	4+4	0230-0883	0232-0205	0232-0206
SPORTSMAN 500 96-13	FRONT	12X7	4/156	4+3	0230-0871	0232-0205	0232-0206
	REAR	12X8	4/156	4+4	0230-0876	0232-0205	0232-0206
	FRONT	14X7	4/156	4+3	0230-0880	0232-0205	0232-0206
	REAR	14X8	4/156	4+4	0230-0883	0232-0205	0232-0206
MAGNUM 500 02-06	FRONT	12X7	4/156	4+3	0230-0871	0232-0205	0232-0206
	REAR	12X8	4/156	4+4	0230-0876	0232-0205	0232-0206
	FRONT	14X7	4/156	4+3	0230-0880	0232-0205	0232-0206
	REAR	14X8	4/156	4+4	0230-0883	0232-0205	0232-0206
SPORTSMAN 570 14-13	FRONT	12X7	4/156	4+3	0230-0871	0232-0205	0232-0206
	REAR	12X8	4/156	4+4	0230-0876	0232-0205	0232-0206
	FRONT	14X7	4/156	4+3	0230-0880	0232-0205	0232-0206
	REAR	14X8	4/156	4+4	0230-0883	0232-0205	0232-0206
SPORTSMAN 600 03-08	FRONT	12X7	4/156	4+3	0230-0871	0232-0205	0232-0206
	REAR	12X8	4/156	4+4	0230-0876	0232-0205	0232-0206
	FRONT	14X7	4/156	4+3	0230-0880	0232-0205	0232-0206
	REAR	14X8	4/156	4+4	0230-0883	0232-0205	0232-0206
SPORTSMAN 700 02-09	FRONT	12X7	4/156	4+3	0230-0871	0232-0205	0232-0206
	REAR	12X8	4/156	4+4	0230-0876	0232-0205	0232-0206
	FRONT	14X7	4/156	4+3	0230-0880	0232-0205	0232-0206
	REAR	14X8	4/156	4+4	0230-0883	0232-0205	0232-0206
SPORTSMAN 800 05-14	FRONT	12X7	4/156	4+3	0230-0871	0232-0205	0232-0206
	REAR	12X8	4/156	4+4	0230-0876	0232-0205	0232-0206
	FRONT	14X7	4/156	4+3	0230-0880	0232-0205	0232-0206
	REAR	14X8	4/156	4+4	0230-0883	0232-0205	0232-0206
RANGER ETX/570/EV/ 800 6X6 4X4 03-19	FRONT	12X7	4/156	4+3	0230-0871	0232-0205	0232-0206
	REAR	12X8	4/156	4+4	0230-0876	0232-0205	0232-0206
	FRONT	14X7	4/156	4+3	0230-0880	0232-0205	0232-0206
	REAR	14X8	4/156	4+4	0230-0883	0232-0205	0232-0206
RANGER XP900 & DIESEL & 1000 14-19	FRONT	12X7	4/156	4+3	0230-0871	0232-0209	-
	REAR	12X8	4/156	4+4	0230-0876	0232-0209	-
	FRONT	14X7	4/156	4+3	0230-0880	0232-0209	-
	REAR	14X8	4/156	4+4	0230-0883	0232-0209	-
SPORTSMAN ACE 570/900 14-17	FRONT	12X7	4/156	4+3	0230-0871	0232-0205	0232-0206
	REAR	12X8	4/156	4+4	0230-0876	0232-0205	0232-0206
	FRONT	14X7	4/156	4+3	0230-0880	0232-0205	0232-0206
	REAR	14X8	4/156	4+4	0230-0883	0232-0205	0232-0206

FITS MODEL	POSITION	SIZE	BOLT PATTERN	OFFSET	WHEEL PART #	LUG NUT CHROME (16-PK) PART #	LUG NUT BLACK (16-PK) PART #
112X ATV/UTV WHEELS (CON'T)							
POLARIS (CON'T)							
SPORTSMAN XP 550/700/800/850/1000 09-19	FRONT	12X7	4/156	4+3	0230-0871	0232-0203	0232-0204
* SPORTSMAN XP 2009 IS 12.5 CM (5") WIDER WITH AFTER MARKET WHEELS	REAR	12X8	4/156	4+4	0230-0876	0232-0203	0232-0204
	FRONT	14X7	4/156	4+3	0230-0880	0232-0203	0232-0204
	REAR	14X8	4/156	4+4	0230-0883	0232-0203	0232-0204
SPORTSMAN X2 500/550/800 09-19	FRONT	12X7	4/156	4+3	0230-0871	0232-0205	0232-0206
	REAR	12X8	4/156	4+4	0230-0876	0232-0205	0232-0206
	FRONT	14X7	4/156	4+3	0230-0880	0232-0205	0232-0206
	REAR	14X8	4/156	4+4	0230-0883	0232-0205	0232-0206
RZR 800/900XP /08-14 & RZR 570 14-16	FRONT	12X7	4/156	4+3	0230-0871	0232-0205	0232-0206
	REAR	12X8	4/156	4+4	0230-0876	0232-0205	0232-0206
	FRONT	14X7	4/156	4+3	0230-0880	0232-0205	0232-0206
	REAR	14X8	4/156	4+4	0230-0883	0232-0205	0232-0206
RZR 900/900 XC/900/1000 S 15-19	FRONT	12X7	4/156	4+3	0230-0871	0232-0209	-
	REAR	12X8	4/156	4+4	0230-0876	0232-0209	-
	FRONT	14X7	4/156	4+3	0230-0880	0232-0209	-
	REAR	14X8	4/156	4+4	0230-0883	0232-0209	-
RZR1000 XP 14-19	FRONT	12X7	4/156	4+3	0230-0871	0232-0209	-
	REAR	12X8	4/156	4+4	0230-0876	0232-0209	-
	FRONT	14X7	4/156	4+3	0230-0880	0232-0209	-
	REAR	14X8	4/156	4+4	0230-0883	0232-0209	-
GENERAL 17-19	FRONT	12X7	4/156	4+3	0230-0871	0232-0209	-
	REAR	12X8	4/156	4+4	0230-0876	0232-0209	-
	FRONT	14X7	4/156	4+3	0230-0880	0232-0209	-
	REAR	14X8	4/156	4+4	0230-0883	0232-0209	-
SUZUKI							
KING QUAD 450/700/750 05-19	FRONT	12X7	4/110	4+3	0230-0873	0232-0203	0232-0204
	REAR	12X8	4/110	4+4	0230-0878	0232-0203	0232-0204
	FRONT	14X7	4/110	4+3	0230-0882	0232-0203	0232-0204
	REAR	14X8	4/110	4+4	0230-0885	0232-0203	0232-0204
YAMAHA							
GRIZZLY 350 IRS 07-15	FRONT	12X7	4/110	4+3	0230-0873	0232-0203	0232-0204
	REAR	12X8	4/110	4+4	0230-0878	0232-0203	0232-0204
	FRONT	14X7	4/110	4+3	0230-0882	0232-0203	0232-0204
	REAR	14X8	4/110	4+4	0230-0885	0232-0203	0232-0204
KODIAK 400/450 4X4 05-06	FRONT	12X7	4/110	4+3	0230-0873	0232-0203	0232-0204
	REAR	12X8	4/110	4+4	0230-0878	0232-0203	0232-0204
	FRONT	14X7	4/110	4+3	0230-0882	0232-0203	0232-0204
	REAR	14X8	4/110	4+4	0230-0885	0232-0203	0232-0204
GRIZZLY 400/450/550/700 4X4 07-19	FRONT	12X7	4/110	4+3	0230-0873	0232-0203	0232-0204
	REAR	12X8	4/110	4+4	0230-0878	0232-0203	0232-0204
	FRONT	14X7	4/110	4+3	0230-0882	0232-0203	0232-0204
	REAR	14X8	4/110	4+4	0230-0885	0232-0203	0232-0204
BIG BEAR 400 IRS 07-12	FRONT	12X7	4/110	4+3	0230-0873	0232-0203	0232-0204
	REAR	12X8	4/110	4+4	0230-0878	0232-0203	0232-0204
	FRONT	14X7	4/110	4+3	0230-0882	0232-0203	0232-0204
	REAR	14X8	4/110	4+4	0230-0885	0232-0203	0232-0204
GRIZZLY 660 02-09	FRONT	12X7	4/110	4+3	0230-0873	0232-0203	0232-0204
	REAR	12X8	4/110	4+4	0230-0878	0232-0203	0232-0204
	FRONT	14X7	4/110	4+3	0230-0882	0232-0203	0232-0204
	REAR	14X8	4/110	4+4	0230-0885	0232-0203	0232-0204
RHINO 450/660/700 04-13	FRONT	12X7	4/110	4+3	0230-0873	0232-0203	0232-0204
	REAR	12X8	4/110	4+4	0230-0878	0232-0203	0232-0204
	FRONT	14X7	4/110	4+3	0230-0882	0232-0203	0232-0204
	REAR	14X8	4/110	4+4	0230-0885	0232-0203	0232-0204
VIKING 14-19	FRONT	12X7	4/110	4+3	0230-0873	0232-0207	0232-0208
	REAR	12X8	4/110	4+4	0230-0878	0232-0207	0232-0208
	FRONT	14X7	4/110	4+3	0230-0882	0232-0207	0232-0208
	REAR	14X8	4/110	4+4	0230-0885	0232-0207	0232-0208
WOLVERINE 16-19	FRONT	12X7	4/110	4+3	0230-0873	0232-0207	0232-0208
	REAR	12X8	4/110	4+4	0230-0878	0232-0207	0232-0208
	FRONT	14X7	4/110	4+3	0230-0882	0232-0207	0232-0208
	REAR	14X8	4/110	4+4	0230-0885	0232-0207	0232-0208
YXZ 1000R 16-18	FRONT	14X7	4/110	4+3	0230-0882	0232-0207	0232-0208
	REAR	14X8	4/110	4+4	0230-0885	0232-0207	0232-0208
YXZ 1000R 19	FRONT	14X7	4/156	4+3	0230-0880	0232-0207	0232-0208
	REAR	14X8	4/156	4+4	0230-0883	0232-0207	0232-0208





548X™

548X ATV/UTV WHEELS

Whether it's in the woods, deep mud or sand, the 548X is prepared to take it on. Handles load capacities from 675 lbs. for the 12x7, 14x7 front to 1150 lbs. for the 12x8 and 14x8 rear which meet, or exceed all current market requirements. Separate yourself from the herd with a line of wheels that are 100% x-rayed on the production line to ensure quality and reliability. Center caps are included with each wheel (replacement center caps 0223-0164), but lug nuts must be ordered separately.

FITS MODEL	POSITION	SIZE	BOLT PATTERN	OFFSET	WHEEL PART #	LUG NUT CHROME (16-PK) PART #	LUG NUT BLACK (16-PK) PART #
548X ATV/UTV WHEELS							
ARCTIC CAT							
250/300 2X4/4X4 98-02	FRONT	12X7	4/115	4+3	0230-0734	0232-0203	0232-0204
300/400/500/650/700/1000 2X4/4X4 02-19	REAR	12X8	4/115	4+4	0230-0735	0232-0203	0232-0204
CAN-AM							
OUTLANDER 330/400/500/570/650/800/850/1000 03-19	FRONT	12X7	4/136	4+3	0230-0736	0232-0203	0232-0204
	REAR	12X8	4/136	4+4	0230-0737	0232-0203	0232-0204
	FRONT	14X7	4/136	4+3	0230-0742	0232-0203	0232-0204
	REAR	14X8	4/136	4+4	0230-0743	0232-0203	0232-0204
RENEGADE 500/570/800/850/1000 09-19	FRONT	12X7	4/136	4+3	0230-0736	0232-0203	0232-0204
	REAR	12X8	4/136	4+4	0230-0737	0232-0203	0232-0204
	FRONT	14X7	4/136	4+3	0230-0742	0232-0203	0232-0204
	REAR	14X8	4/136	4+4	0230-0743	0232-0203	0232-0204
MAVERICK/MAX 1000 14-19	FRONT	12X7	4/136	4+3	0230-0736	0232-0203	0232-0204
	REAR	12X8	4/136	4+4	0230-0737	0232-0203	0232-0204
	FRONT	14X7	4/136	4+3	0230-0742	0232-0203	0232-0204
	REAR	14X8	4/136	4+4	0230-0743	0232-0203	0232-0204
COMMANDER 800/1000 13-19	FRONT	12X7	4/136	4+3	0230-0736	0232-0203	0232-0204
	REAR	12X8	4/136	4+4	0230-0737	0232-0203	0232-0204
	FRONT	14X7	4/136	4+3	0230-0742	0232-0203	0232-0204
	REAR	14X8	4/136	4+4	0230-0743	0232-0203	0232-0204

WHEELS & TIRES

FITS MODEL	POSITION	SIZE	BOLT PATTERN	OFFSET	WHEEL PART #	LUG NUT CHROME (16-PK) PART #	LUG NUT BLACK (16-PK) PART #
548X ATV/UTV WHEELS (CON'T)							
CAN-AM (CIN'T)							
DEFENDER 1000 16-19	FRONT	12X7	4/136	4+3	0230-0736	0232-0203	0232-0204
	REAR	12X8	4/136	4+4	0230-0737	0232-0203	0232-0204
	FRONT	14X7	4/136	4+3	0230-0742	0232-0203	0232-0204
	REAR	14X8	4/136	4+4	0230-0743	0232-0203	0232-0204
HONDA							
TRX650/680/700 RINCON 4X4 02-19 (IRS)	FRONT	12X7	4/110	4+3	0230-0732	0232-0203	0232-0204
	REAR	12X8	4/110	4+4	0230-0733	0232-0203	0232-0204
	FRONT/REAR	14X7	4/110	4+3	0230-0740	0232-0203	0232-0204
TRX420AT/500AT (IRS) RANCHER 09-19	FRONT	12X7	4/110	4+3	0230-0732	0232-0203	0232-0204
	REAR	12X8	4/110	4+4	0230-0733	0232-0203	0232-0204
	FRONT/REAR	14X7	4/110	4+3	0230-0740	0232-0203	0232-0204
TRX500 FOREMAN RUBICON 15-19 (IRS)	FRONT	12X7	4/110	4+3	0230-0732	0232-0203	0232-0204
	REAR	12X8	4/110	4+4	0230-0733	0232-0203	0232-0204
	FRONT/REAR	14X7	4/110	4+3	0230-0740	0232-0203	0232-0204
BIG RED 700 MUV 09-13	FRONT	12X7	4/110	4+3	0230-0732	0232-0209	-
	REAR	12X8	4/110	4+4	0230-0733	0232-0209	-
	FRONT/REAR	14X7	4/110	4+3	0230-0740	0232-0209	-
PIONEER 500/700 14-19	FRONT	12X7	4/110	4+3	0230-0732	0232-0209	-
	REAR	12X8	4/110	4+4	0230-0733	0232-0209	-
	FRONT/REAR	14X7	4/110	4+3	0230-0740	0232-0209	-
PIONEER 1000 16-19	FRONT	12X7	4/136	4+3	0230-0736	0232-0209	-
	REAR	12X8	4/136	4+4	0230-0737	0232-0209	-
	FRONT	14X7	4/136	4+3	0230-0742	0232-0209	-
	REAR	14X8	4/136	4+4	0230-0743	0232-0209	-
KAWASAKI							
BRUTE FORCE 650I 4X4 06-18 (IRS)	FRONT	12X7	4/110	4+3	0230-0732	0232-0203	0232-0204
	REAR	12X8	4/110	4+4	0230-0733	0232-0203	0232-0204
	FRONT/REAR	14X7	4/110	4+3	0230-0740	0232-0203	0232-0204
BRUTE FORCE 750 4X4 05-19 (IRS)	FRONT	12X7	4/110	4+3	0230-0732	0232-0203	0232-0204
	REAR	12X8	4/110	4+4	0230-0733	0232-0203	0232-0204
	FRONT/REAR	14X7	4/110	4+3	0230-0740	0232-0203	0232-0204
TERYX 750/800 08-19	FRONT	12X7	4/136	4+3	0230-0736	0232-0207	0232-0208
	REAR	12X8	4/136	4+4	0230-0737	0232-0207	0232-0208
	FRONT	14X7	4/136	4+3	0230-0742	0232-0207	0232-0208
	REAR	14X8	4/136	4+4	0230-0743	0232-0207	0232-0208
MULE 2500/3000/4010 SERIES * LIFT KIT NEEDED FOR 66 CM (26") OR LARGER TIRES	FRONT	12X7	4/136	4+3	0230-0736	0232-0207	0232-0208
	REAR	12X8	4/136	4+4	0230-0737	0232-0207	0232-0208
	FRONT	14X7	4/136	4+3	0230-0742	0232-0207	0232-0208
	REAR	14X8	4/136	4+4	0230-0743	0232-0207	0232-0208
MULE PRO FXT 15-19	FRONT	12X7	4/156	4+3	0230-0738	0232-0207	0232-0208
	REAR	12X8	4/156	4+4	0230-0739	0232-0207	0232-0208
	FRONT	14X7	4/156	4+3	0230-0744	0232-0207	0232-0208
	REAR	14X8	4/156	4+4	0230-0745	0232-0207	0232-0208
KYMCO							
500MUX SA 08-10/MXU IE 08-18	FRONT	12X7	4/110	4+3	0230-0732	0232-0203	0232-0204
450/500/700UXV 08-18	REAR	12X8	4/110	4+4	0230-0733	0232-0203	0232-0204
	FRONT/REAR	14X7	4/110	4+3	0230-0740	0232-0203	0232-0204
POLARIS							
SPORTSMAN 335 99-06	FRONT	12X7	4/156	4+3	0230-0738	0232-0205	0232-0206
	REAR	12X8	4/156	4+4	0230-0739	0232-0205	0232-0206
	FRONT	14X7	4/156	4+3	0230-0744	0232-0205	0232-0206
	REAR	14X8	4/156	4+4	0230-0745	0232-0205	0232-0206
SPORTSMAN 400/450 01-16	FRONT	12X7	4/156	4+3	0230-0738	0232-0205	0232-0206
	REAR	12X8	4/156	4+4	0230-0739	0232-0205	0232-0206
	FRONT	14X7	4/156	4+3	0230-0744	0232-0205	0232-0206
	REAR	14X8	4/156	4+4	0230-0745	0232-0205	0232-0206
SPORTSMAN 500 96-13	FRONT	12X7	4/156	4+3	0230-0738	0232-0205	0232-0206
	REAR	12X8	4/156	4+4	0230-0739	0232-0205	0232-0206
	FRONT	14X7	4/156	4+3	0230-0744	0232-0205	0232-0206
	REAR	14X8	4/156	4+4	0230-0745	0232-0205	0232-0206
MAGNUM 500 02-06	FRONT	12X7	4/156	4+3	0230-0738	0232-0205	0232-0206
	REAR	12X8	4/156	4+4	0230-0739	0232-0205	0232-0206
	FRONT	14X7	4/156	4+3	0230-0744	0232-0205	0232-0206
	REAR	14X8	4/156	4+4	0230-0745	0232-0205	0232-0206
SPORTSMAN 570 14-19	FRONT	12X7	4/156	4+3	0230-0738	0232-0205	0232-0206
	REAR	12X8	4/156	4+4	0230-0739	0232-0205	0232-0206
	FRONT	14X7	4/156	4+3	0230-0744	0232-0205	0232-0206
	REAR	14X8	4/156	4+4	0230-0745	0232-0205	0232-0206
SPORTSMAN 600 03-09	FRONT	12X7	4/156	4+3	0230-0738	0232-0205	0232-0206
	REAR	12X8	4/156	4+4	0230-0739	0232-0205	0232-0206
	FRONT	14X7	4/156	4+3	0230-0744	0232-0205	0232-0206
	REAR	14X8	4/156	4+4	0230-0745	0232-0205	0232-0206
SPORTSMAN 700 02-09	FRONT	12X7	4/156	4+3	0230-0738	0232-0205	0232-0206
	REAR	12X8	4/156	4+4	0230-0739	0232-0205	0232-0206

FITS MODEL	POSITION	SIZE	BOLT PATTERN	OFFSET	WHEEL PART #	LUG NUT CHROME (16-PK) PART #	LUG NUT BLACK (16-PK) PART #
548X ATV/UTV WHEELS (CON'T)							
POLARIS (CIN'T)							
SPORTSMAN 700 02-09 (CON'T)	FRONT	14X7	4/156	4+3	0230-0744	0232-0205	0232-0206
	REAR	14X8	4/156	4+4	0230-0745	0232-0205	0232-0206
SPORTSMAN 800 05-14	FRONT	12X7	4/156	4+3	0230-0738	0232-0205	0232-0206
	REAR	12X8	4/156	4+4	0230-0739	0232-0205	0232-0206
	FRONT	14X7	4/156	4+3	0230-0744	0232-0205	0232-0206
	REAR	14X8	4/156	4+4	0230-0745	0232-0205	0232-0206
SPORTSMAN XP 550/700/800/850/1000 09-19	FRONT	12X7	4/156	4+3	0230-0738	0232-0203	0232-0204
	REAR	12X8	4/156	4+4	0230-0739	0232-0203	0232-0204
	FRONT	14X7	4/156	4+3	0230-0744	0232-0203	0232-0204
	REAR	14X8	4/156	4+4	0230-0745	0232-0203	0232-0204
SPORTSMAN X2 500/550/800/1000 09-19	FRONT	12X7	4/156	4+3	0230-0738	0232-0205	0232-0206
	REAR	12X8	4/156	4+4	0230-0739	0232-0205	0232-0206
	FRONT	14X7	4/156	4+3	0230-0744	0232-0205	0232-0206
	REAR	14X8	4/156	4+4	0230-0745	0232-0205	0232-0206
SPORTSMAN ACE 570/900 14-19	FRONT	12X7	4/156	4+3	0230-0738	0232-0205	0232-0206
	REAR	12X8	4/156	4+4	0230-0739	0232-0205	0232-0206
	FRONT	14X7	4/156	4+3	0230-0744	0232-0205	0232-0206
	REAR	14X8	4/156	4+4	0230-0745	0232-0205	0232-0206
RANGER ETX/570/EV/ 800 6X6 4X4 03-19	FRONT	12X7	4/156	4+3	0230-0738	0232-0205	0232-0206
	REAR	12X8	4/156	4+4	0230-0739	0232-0205	0232-0206
	FRONT	14X7	4/156	4+3	0230-0744	0232-0205	0232-0206
	REAR	14X8	4/156	4+4	0230-0745	0232-0205	0232-0206
RANGER 570 (FULLSIZE) 14-19	FRONT	12X7	4/156	4+3	0230-0738	0232-0209	-
	REAR	12X8	4/156	4+4	0230-0739	0232-0209	-
	FRONT	14X7	4/156	4+3	0230-0744	0232-0209	-
	REAR	14X8	4/156	4+4	0230-0745	0232-0209	-
RANGER XP900 /1000 & DIESEL 14-19	FRONT	12X7	4/156	4+3	0230-0738	0232-0209	-
	REAR	12X8	4/156	4+4	0230-0739	0232-0209	-
	FRONT	14X7	4/156	4+3	0230-0744	0232-0209	-
	REAR	14X8	4/156	4+4	0230-0745	0232-0209	-
RZR 800/900XP 08-14 & RZR 570 14-19	FRONT	12X7	4/156	4+3	0230-0738	0232-0205	0232-0206
	REAR	12X8	4/156	4+4	0230-0739	0232-0205	0232-0206
	FRONT	14X7	4/156	4+3	0230-0744	0232-0205	0232-0206
	REAR	14X8	4/156	4+4	0230-0745	0232-0205	0232-0206
RZR 900/900 XC/900 S 15-16	FRONT	12X7	4/156	4+3	0230-0738	0232-0209	-
	REAR	12X8	4/156	4+4	0230-0739	0232-0209	-
	FRONT	14X7	4/156	4+3	0230-0744	0232-0209	-
	REAR	14X8	4/156	4+4	0230-0745	0232-0209	-
RZR 1000 XP / 4 14-19	FRONT	12X7	4/156	4+3	0230-0738	0232-0209	-
	REAR	12X8	4/156	4+4	0230-0739	0232-0209	-
	FRONT	14X7	4/156	4+3	0230-0744	0232-0209	-
	REAR	14X8	4/156	4+4	0230-0745	0232-0209	-
SUZUKI							
KING QUAD 450/700/750 05-19 (IRS)	FRONT	12X7	4/110	4+3	0230-0732	0232-0203	0232-0204
	REAR	12X8	4/110	4+4	0230-0733	0232-0203	0232-0204
	FRONT/REAR	14X7	4/110	4+3	0230-0740	0232-0203	0232-0204
YAMAHA							
GRIZZLY 350 IRS 07-15	FRONT	12X7	4/110	4+3	0230-0732	0232-0203	0232-0204
	REAR	12X8	4/110	4+4	0230-0733	0232-0203	0232-0204
	FRONT/REAR	14X7	4/110	4+3	0230-0740	0232-0203	0232-0204
KODIAK 400/450 4X4 05-06 (IRS)	FRONT	12X7	4/110	4+3	0230-0732	0232-0203	0232-0204
	REAR	12X8	4/110	4+4	0230-0733	0232-0203	0232-0204
	FRONT/REAR	14X7	4/110	4+3	0230-0740	0232-0203	0232-0204
GRIZZLY 400/450/550/700 4X4 07-19	FRONT	12X7	4/110	4+3	0230-0732	0232-0203	0232-0204
	REAR	12X8	4/110	4+4	0230-0733	0232-0203	0232-0204
	FRONT/REAR	14X7	4/110	4+3	0230-0740	0232-0203	0232-0204
BIG BEAR 400 IRS 07-11	FRONT	12X7	4/110	4+3	0230-0732	0232-0203	0232-0204
	REAR	12X8	4/110	4+4	0230-0733	0232-0203	0232-0204
	FRONT/REAR	14X7	4/110	4+3	0230-0740	0232-0203	0232-0204
GRIZZLY 660 02-09	FRONT	12X7	4/110	4+3	0230-0732	0232-0203	0232-0204
	REAR	12X8	4/110	4+4	0230-0733	0232-0203	0232-0204
	FRONT/REAR	14X7	4/110	4+3	0230-0740	0232-0203	0232-0204
KODIAK 700 16	FRONT	12X7	4/110	4+3	0230-0732	0232-0203	0232-0204
	REAR	12X8	4/110	4+4	0230-0733	0232-0203	0232-0204
	FRONT/REAR	14X7	4/110	4+3	0230-0740	0232-0203	0232-0204
RHINO 450/660/700 04-13	FRONT	12X7	4/110	4+3	0230-0732	0232-0203	0232-0204
	REAR	12X8	4/110	4+4	0230-0733	0232-0203	0232-0204
	FRONT/REAR	14X7	4/110	4+3	0230-0740	0232-0203	0232-0204
VIKING 14-19	FRONT	12X7	4/110	4+3	0230-0732	0232-0207	0232-0208
	REAR	12X8	4/110	4+4	0230-0733	0232-0207	0232-0208
	FRONT/REAR	14X7	4/110	4+3	0230-0740	0232-0207	0232-0208
WOLVERINE 16-19	FRONT	12X7	4/110	4+3	0230-0732	0232-0207	0232-0208
	REAR	12X8	4/110	4+4	0230-0733	0232-0207	0232-0208
	FRONT/REAR	14X7	4/110	4+3	0230-0740	0232-0207	0232-0208
YZX 1000R 16-18	FRONT/REAR	14X7	4/110	4+3	0230-0740	0232-0207	0232-0208





393X™

393X ATV/UTV WHEELS

Whether it's in the woods, deep mud or sand, the 393X is prepared to take it on. Handles load capacities from 675 lbs. for the 12x7, 14x7 and 15x7 front to 1150 lbs. for the 12x8 and 15x8 rear which meet, or exceed all current market requirements. Separate yourself from the herd with a line of wheels that are 100% x-rayed on the production line to ensure quality and reliability. Available in gloss black with chrome center caps and black torx head rivets. Center caps are included with each wheel (replacement center caps 0232-0211 for 4/110 bolt pattern, 0232-0210 for 4/136, 4/156 and 4/4 bolt patterns). Lug nuts must be ordered separately.

FITS MODEL	POSITION	SIZE	BOLT PATTERN	OFFSET	WHEEL PART #	LUG NUT CHROME (16-PK) PART #	LUG NUT BLACK (16-PK) PART #
393X ATV/UTV WHEELS							
CAN-AM							
OUTLANDER 330/400/500/570/650/800/850/1000 Q3-19	FRONT	12X7	4/136	4+3	0230-0518	0232-0203	0232-0204
	REAR	12X8	4/136	4+4	0230-0523	0232-0203	0232-0204
	FRONT	14X7	4/136	4+3	0230-0526	0232-0203	0232-0204
	REAR	14X8	4/136	4+4	0230-0531	0232-0203	0232-0204
	FRONT	15X7	4/136	4+3	0230-0534	0232-0203	0232-0204
	REAR	15X8	4/136	4+4	-	0232-0203	0232-0204
RENEGADE 500/570/800/850/1000 09-19	FRONT	12X7	4/136	4+3	0230-0518	0232-0203	0232-0204
	REAR	12X8	4/136	4+4	0230-0523	0232-0203	0232-0204
	FRONT	14X7	4/136	4+3	0230-0526	0232-0203	0232-0204
	REAR	14X8	4/136	4+4	0230-0531	0232-0203	0232-0204
	FRONT	15X7	4/136	4+3	0230-0534	0232-0203	0232-0204
	REAR	15X8	4/136	4+4	0230-0537	0232-0203	0232-0204
COMMANDER 800/1000 13-19	FRONT	12X7	4/136	4+3	0230-0518	0232-0203	0232-0204
	REAR	12X8	4/136	4+4	0230-0523	0232-0203	0232-0204
	FRONT	14X7	4/136	4+3	0230-0526	0232-0203	0232-0204
	REAR	14X8	4/136	4+4	0230-0531	0232-0203	0232-0204
	FRONT	15X7	4/136	4+3	0230-0534	0232-0203	0232-0204
	REAR	15X8	4/136	4+4	0230-0537	0232-0203	0232-0204
MAVERICK/MAX 1000 14-19	FRONT	12X7	4/136	4+3	0230-0518	0232-0203	0232-0204
	REAR	12X8	4/136	4+4	0230-0523	0232-0203	0232-0204
	FRONT	14X7	4/136	4+3	0230-0526	0232-0203	0232-0204
	REAR	14X8	4/136	4+4	0230-0531	0232-0203	0232-0204
	FRONT	15X7	4/136	4+3	0230-0534	0232-0203	0232-0204
	REAR	15X8	4/136	4+4	0230-0537	0232-0203	0232-0204



WHEELS & TIRES

FITS MODEL	POSITION	SIZE	BOLT PATTERN	OFFSET	WHEEL PART #	LUG NUT CHROME (16-PK) PART #	LUG NUT BLACK (16-PK) PART #
393X ATV/UTV WHEELS (CON'T)							
CAN-AM (CON'T)							
DEFENDER 16-19	FRONT	12X7	4/136	4+3	0230-0518	0232-0203	0232-0204
	REAR	12X8	4/136	4+4	0230-0523	0232-0203	0232-0204
	FRONT	14X7	4/136	4+3	0230-0526	0232-0203	0232-0204
	REAR	14X8	4/136	4+4	0230-0531	0232-0203	0232-0204
	FRONT	15X7	4/136	4+3	0230-0534	0232-0203	0232-0204
	REAR	15X8	4/136	4+4	0230-0537	0232-0203	0232-0204
HONDA							
TRX420AT/500AT RANCHER 09-19 (IRS)	FRONT	12X7	4/110	4+3	0230-0519	0232-0203	0232-0204
	REAR	12X8	4/110	4+4	0230-0524	0232-0203	0232-0204
	FRONT	14X7	4/110	4+3	0230-0527	0232-0203	0232-0204
	REAR	14X8	4/110	4+4	0230-0532	0232-0203	0232-0204
	FRONT	15X7	4/110	4+3	0230-0535	0232-0203	0232-0204
	REAR	15X8	4/110	4+4	-	0232-0203	0232-0204
TRX650/680 RINCON 4X4 02-19 (IRS)	FRONT	12X7	4/110	4+3	0230-0519	0232-0203	0232-0204
	REAR	12X8	4/110	4+4	0230-0524	0232-0203	0232-0204
	FRONT	14X7	4/110	4+3	0230-0527	0232-0203	0232-0204
	REAR	14X8	4/110	4+4	0230-0532	0232-0203	0232-0204
	FRONT	15X7	4/110	4+3	0230-0535	0232-0203	0232-0204
	REAR	15X8	4/110	4+4	0230-0538	0232-0203	0232-0204
BIG RED 700 MUV 09-13	FRONT	12X7	4/110	4+3	0230-0519	0232-0209	-
	REAR	12X8	4/110	4+4	0230-0524	0232-0209	-
	FRONT	14X7	4/110	4+3	0230-0527	0232-0209	-
	REAR	14X8	4/110	4+4	0230-0532	0232-0209	-
	FRONT	15X7	4/110	4+3	0230-0535	0232-0209	-
	REAR	15X8	4/110	4+4	0230-0538	0232-0209	-
PIONEER 500/700 14-19	FRONT	12X7	4/110	4+3	0230-0519	0232-0209	-
	REAR	12X8	4/110	4+4	0230-0524	0232-0209	-
	FRONT	14X7	4/110	4+3	0230-0527	0232-0209	-
	REAR	14X8	4/110	4+4	0230-0532	0232-0209	-
	FRONT	15X7	4/110	4+3	0230-0535	0232-0209	-
	REAR	15X8	4/110	4+4	0230-0538	0232-0209	-
PIONEER 1000 16-19	FRONT	12X7	4/136	4+3	0230-0518	0232-0209	-
	REAR	12X8	4/136	4+4	0230-0523	0232-0209	-
	FRONT	14X7	4/136	4+3	0230-0526	0232-0209	-
	REAR	14X8	4/136	4+4	0230-0531	0232-0209	-
	FRONT	15X7	4/136	4+3	0230-0534	0232-0209	-
	REAR	15X8	4/136	4+4	0230-0537	0232-0209	-
KAWASAKI							
BRUTE FORCE 650I 4X4 06-18 (IRS MODEL)	FRONT	12X7	4/110	4+3	0230-0519	0232-0203	0232-0204
	REAR	12X8	4/110	4+4	0230-0524	0232-0203	0232-0204
	FRONT	14X7	4/110	4+3	0230-0527	0232-0203	0232-0204
	REAR	14X8	4/110	4+4	0230-0532	0232-0203	0232-0204
	FRONT	15X7	4/110	4+3	0230-0535	0232-0203	0232-0204
	REAR	15X8	4/110	4+4	0230-0538	0232-0203	0232-0204
BRUTE FORCE 750 4X4 05-19	FRONT	12X7	4/110	4+3	0230-0519	0232-0203	0232-0204
	REAR	12X8	4/110	4+4	0230-0524	0232-0203	0232-0204
	FRONT	14X7	4/110	4+3	0230-0527	0232-0203	0232-0204
	REAR	14X8	4/110	4+4	0230-0532	0232-0203	0232-0204
	FRONT	15X7	4/110	4+3	0230-0535	0232-0203	0232-0204
	REAR	15X8	4/110	4+4	0230-0538	0232-0203	0232-0204
TERYX 750/800 08-19	FRONT	12X7	4/136	4+3	0230-0518	0232-0207	0232-0208
	REAR	12X8	4/136	4+4	0230-0523	0232-0207	0232-0208
	FRONT	14X7	4/136	4+3	0230-0526	0232-0207	0232-0208
	REAR	14X8	4/136	4+4	0230-0531	0232-0207	0232-0208
	FRONT	15X7	4/136	4+3	0230-0534	0232-0207	0232-0208
	REAR	15X8	4/136	4+4	0230-0537	0232-0207	0232-0208
MULE 550/600/610 ALL YEARS	FRONT	12X7	4/136	4+3	0230-0518	0232-0203	0232-0204
	REAR	12X8	4/136	4+4	0230-0523	0232-0203	0232-0204
MULE 2500/3000/4010 SERIES	FRONT	12X7	4/136	4+3	0230-0518	0232-0207	0232-0208
	REAR	12X8	4/136	4+4	0230-0523	0232-0207	0232-0208
* LIFT KIT NEEDED FOR 66 CM (26") OR LARGER TIRES	FRONT	14X7	4/136	4+3	0230-0526	0232-0207	0232-0208
	REAR	14X8	4/136	4+4	0230-0531	0232-0207	0232-0208
	FRONT	15X7	4/136	4+3	0230-0534	0232-0207	0232-0208
	REAR	15X8	4/136	4+4	0230-0537	0232-0207	0232-0208
KYMCO							
500MUX SA 08-10/MXU IE 08-11/500 UXV 10-14	FRONT	12X7	4/110	4+3	0230-0519	0232-0203	0232-0204
	REAR	12X8	4/110	4+4	0230-0524	0232-0203	0232-0204
375/500/700 MXU-IE 08-18	FRONT	12X7	4/110	4+3	0230-0519	0232-0203	0232-0204
	REAR	12X8	4/110	4+4	0230-0524	0232-0203	0232-0204
450/500/700 UXV 08-18	FRONT	12X7	4/110	4+3	0230-0519	0232-0203	0232-0204
	REAR	12X8	4/110	4+4	0230-0524	0232-0203	0232-0204
POLARIS							
SPORTSMAN 335 99-06	FRONT	12X7	4/156	4+3	0230-0517	0232-0205	0232-0206
	REAR	12X8	4/156	4+4	0230-0522	0232-0205	0232-0206

FITS MODEL	POSITION	SIZE	BOLT PATTERN	OFFSET	WHEEL PART #	LUG NUT CHROME (16-PK) PART #	LUG NUT BLACK (16-PK) PART #
393X ATV/UTV WHEELS (CON'T)							
POLARIS (CON'T)							
SPORTSMAN 335 99-06 (CON'T)	FRONT	14X7	4/156	4+3	0230-0525	0232-0205	0232-0206
	REAR	14X8	4/156	4+4	0230-0530	0232-0205	0232-0206
	FRONT	15X7	4/156	4+3	0230-0533	0232-0205	0232-0206
	REAR	15X8	4/156	4+4	0230-0536	0232-0205	0232-0206
SPORTSMAN 400/450 01-13	FRONT	12X7	4/156	4+3	0230-0517	0232-0205	0232-0206
	REAR	12X8	4/156	4+4	0230-0522	0232-0205	0232-0206
	FRONT	14X7	4/156	4+3	0230-0525	0232-0205	0232-0206
	REAR	14X8	4/156	4+4	0230-0530	0232-0205	0232-0206
SPORTSMAN 500 96-13	FRONT	15X7	4/156	4+3	0230-0533	0232-0205	0232-0206
	REAR	15X8	4/156	4+4	0230-0536	0232-0205	0232-0206
	FRONT	12X7	4/156	4+3	0230-0517	0232-0205	0232-0206
	REAR	12X8	4/156	4+4	0230-0522	0232-0205	0232-0206
MAGNUM 500 02-06	FRONT	14X7	4/156	4+3	0230-0525	0232-0205	0232-0206
	REAR	14X8	4/156	4+4	0230-0530	0232-0205	0232-0206
	FRONT	15X7	4/156	4+3	0230-0533	0232-0205	0232-0206
	REAR	15X8	4/156	4+4	0230-0536	0232-0205	0232-0206
SPORTSMAN 570 14-16	FRONT	12X7	4/156	4+3	0230-0517	0232-0205	0232-0206
	REAR	12X8	4/156	4+4	0230-0522	0232-0205	0232-0206
	FRONT	14X7	4/156	4+3	0230-0525	0232-0205	0232-0206
	REAR	14X8	4/156	4+4	0230-0530	0232-0205	0232-0206
SPORTSMAN 600 03-09	FRONT	15X7	4/156	4+3	0230-0533	0232-0205	0232-0206
	REAR	15X8	4/156	4+4	0230-0536	0232-0205	0232-0206
	FRONT	12X7	4/156	4+3	0230-0517	0232-0205	0232-0206
	REAR	12X8	4/156	4+4	0230-0522	0232-0205	0232-0206
SPORTSMAN 700 02-09	FRONT	14X7	4/156	4+3	0230-0525	0232-0205	0232-0206
	REAR	14X8	4/156	4+4	0230-0530	0232-0205	0232-0206
	FRONT	15X7	4/156	4+3	0230-0533	0232-0205	0232-0206
	REAR	15X8	4/156	4+4	0230-0536	0232-0205	0232-0206
SPORTSMAN 800 05-14	FRONT	12X7	4/156	4+3	0230-0517	0232-0205	0232-0206
	REAR	12X8	4/156	4+4	0230-0522	0232-0205	0232-0206
	FRONT	14X7	4/156	4+3	0230-0525	0232-0205	0232-0206
	REAR	14X8	4/156	4+4	0230-0530	0232-0205	0232-0206
SPORTSMAN XP 550/700/800/850 09-19	FRONT	15X7	4/156	4+3	0230-0533	0232-0205	0232-0206
	REAR	15X8	4/156	4+4	0230-0536	0232-0205	0232-0206
	FRONT	12X7	4/156	4+3	0230-0517	0232-0203	0232-0204
	REAR	12X8	4/156	4+4	0230-0522	0232-0203	0232-0204
* SPORTSMAN XP 2009 IS 12,5 CM (5") WIDER WITH AFTER MARKET WHEELS	FRONT	14X7	4/156	4+3	0230-0525	0232-0203	0232-0204
	REAR	14X8	4/156	4+4	0230-0530	0232-0203	0232-0204
SPORTSMAN X2 500/550/800 09-15	FRONT	15X7	4/156	4+3	0230-0533	0232-0203	0232-0204
	REAR	15X8	4/156	4+4	0230-0536	0232-0203	0232-0204
	FRONT	12X7	4/156	4+3	0230-0517	0232-0205	0232-0206
	REAR	12X8	4/156	4+4	0230-0522	0232-0205	0232-0206
SPORTSMAN ACE 570/900 14-19	FRONT	14X7	4/156	4+3	0230-0525	0232-0205	0232-0206
	REAR	14X8	4/156	4+4	0230-0530	0232-0205	0232-0206
	FRONT	15X7	4/156	4+3	0230-0533	0232-0205	0232-0206
	REAR	15X8	4/156	4+4	0230-0536	0232-0205	0232-0206
RANGER 570 (FULLSIZE) 14-19	FRONT	12X7	4/156	4+3	0230-0517	0232-0209	-
	REAR	12X8	4/156	4+4	0230-0522	0232-0209	-
	FRONT	14X7	4/156	4+3	0230-0525	0232-0209	-
	REAR	14X8	4/156	4+4	0230-0530	0232-0209	-
RANGER XP900 & DIESEL 14-19	FRONT	15X7	4/156	4+3	0230-0533	0232-0209	-
	REAR	15X8	4/156	4+4	0230-0536	0232-0209	-
	FRONT	12X7	4/156	4+3	0230-0517	0232-0209	-
	REAR	12X8	4/156	4+4	0230-0522	0232-0209	-
	FRONT	14X7	4/156	4+3	0230-0525	0232-0209	-
	REAR	14X8	4/156	4+4	0230-0530	0232-0209	-

WHEELS & TIRES

FITS MODEL	POSITION	SIZE	BOLT PATTERN	OFFSET	WHEEL PART #	LUG NUT CHROME (16-PK) PART #	LUG NUT BLACK (16-PK) PART #
393X ATV/UTV WHEELS (CON'T)							
POLARIS (CON'T)							
RANGER XP900 & DIESEL 14-19 (CON'T)	FRONT	15X7	4/156	4+3	0230-0533	0232-0209	-
	REAR	15X8	4/156	4+4	0230-0536	0232-0209	-
RANGER ETX/570/EV/ 800 6X6 4X4 03-19	FRONT	12X7	4/156	4+3	0230-0517	0232-0205	0232-0206
	REAR	12X8	4/156	4+4	0230-0522	0232-0205	0232-0206
	FRONT	14X7	4/156	4+3	0230-0525	0232-0205	0232-0206
	REAR	14X8	4/156	4+4	0230-0530	0232-0205	0232-0206
	FRONT	15X7	4/156	4+3	0230-0533	0232-0205	0232-0206
	REAR	15X8	4/156	4+4	0230-0536	0232-0205	0232-0206
RANGER 400 / 400EV 10-19	FRONT	12X7	4/156	4+3	0230-0517	0232-0205	0232-0206
	REAR	12X8	4/156	4+4	0230-0522	0232-0205	0232-0206
	FRONT	14X7	4/156	4+3	0230-0525	0232-0205	0232-0206
	REAR	14X8	4/156	4+4	0230-0530	0232-0205	0232-0206
	FRONT	15X7	4/156	4+3	0230-0533	0232-0205	0232-0206
	REAR	15X8	4/156	4+4	0230-0536	0232-0205	0232-0206
RZR 800/900XP 08-14 & RZR 570 14-19	FRONT	12X7	4/156	4+3	0230-0517	0232-0205	0232-0206
	REAR	12X8	4/156	4+4	0230-0522	0232-0205	0232-0206
	FRONT	14X7	4/156	4+3	0230-0525	0232-0205	0232-0206
	REAR	14X8	4/156	4+4	0230-0530	0232-0205	0232-0206
	FRONT	15X7	4/156	4+3	0230-0533	0232-0205	0232-0206
	REAR	15X8	4/156	4+4	0230-0536	0232-0205	0232-0206
RZR 900/900 XC/900/ S 15-18 / RZR 1000 14-19	FRONT	12X7	4/156	4+3	0230-0517	0232-0209	-
	REAR	12X8	4/156	4+4	0230-0522	0232-0209	-
	FRONT	14X7	4/156	4+3	0230-0525	0232-0209	-
	REAR	14X8	4/156	4+4	0230-0530	0232-0209	-
	FRONT	15X7	4/156	4+3	0230-0533	0232-0209	-
	REAR	15X8	4/156	4+4	0230-0536	0232-0209	-
GENERAL 17-19	FRONT	12X7	4/156	4+3	0230-0517	0232-0209	-
	REAR	12X8	4/156	4+4	0230-0522	0232-0209	-
	FRONT	14X7	4/156	4+3	0230-0525	0232-0209	-
	REAR	14X8	4/156	4+4	0230-0530	0232-0209	-
	FRONT	15X7	4/156	4+3	0230-0533	0232-0209	-
	REAR	15X8	4/156	4+4	0230-0536	0232-0209	-
SUZUKI							
KING QUAD 450/700/750 05-19	FRONT	12X7	4/110	4+3	0230-0519	0232-0203	0232-0204
	REAR	12X8	4/110	4+4	0230-0524	0232-0203	0232-0204
	FRONT	14X7	4/110	4+3	0230-0527	0232-0203	0232-0204
	REAR	14X8	4/110	4+4	0230-0532	0232-0203	0232-0204
	FRONT	15X7	4/110	4+3	0230-0535	0232-0203	0232-0204
	REAR	15X8	4/110	4+4	0230-0538	0232-0203	0232-0204
YAMAHA							
GRIZZLY 350 IRS 07-19	FRONT	12X7	4/110	4+3	0230-0519	0232-0203	0232-0204
	REAR	12X8	4/110	4+4	0230-0524	0232-0203	0232-0204
	FRONT	14X7	4/110	4+3	0230-0527	0232-0203	0232-0204
	REAR	14X8	4/110	4+4	0230-0532	0232-0203	0232-0204
	FRONT	15X7	4/110	4+3	0230-0535	0232-0203	0232-0204
	REAR	15X8	4/110	4+4	0230-0538	0232-0203	0232-0204
BIG BEAR 400 IRS 07-12	FRONT	12X7	4/110	4+3	0230-0519	0232-0203	0232-0204
	REAR	12X8	4/110	4+4	0230-0524	0232-0203	0232-0204
	FRONT	14X7	4/110	4+3	0230-0527	0232-0203	0232-0204
	REAR	14X8	4/110	4+4	0230-0532	0232-0203	0232-0204
	FRONT	15X7	4/110	4+3	0230-0535	0232-0203	0232-0204
	REAR	15X8	4/110	4+4	0230-0538	0232-0203	0232-0204
KODIAK 400/450 4X4 05-06	FRONT	12X7	4/110	4+3	0230-0519	0232-0203	0232-0204
	REAR	12X8	4/110	4+4	0230-0524	0232-0203	0232-0204
	FRONT	14X7	4/110	4+3	0230-0527	0232-0203	0232-0204
	REAR	14X8	4/110	4+4	0230-0532	0232-0203	0232-0204
	FRONT	15X7	4/110	4+3	0230-0535	0232-0203	0232-0204
	REAR	15X8	4/110	4+4	0230-0538	0232-0203	0232-0204
GRIZZLY 400/450/550/700 4X4 07-19	FRONT	12X7	4/110	4+3	0230-0519	0232-0203	0232-0204
	REAR	12X8	4/110	4+4	0230-0524	0232-0203	0232-0204
	FRONT	14X7	4/110	4+3	0230-0527	0232-0203	0232-0204
	REAR	14X8	4/110	4+4	0230-0532	0232-0203	0232-0204
	FRONT	15X7	4/110	4+3	0230-0535	0232-0203	0232-0204
	REAR	15X8	4/110	4+4	0230-0538	0232-0203	0232-0204
GRIZZLY 660 02-09	FRONT	12X7	4/110	4+3	0230-0519	0232-0203	0232-0204
	REAR	12X8	4/110	4+4	0230-0524	0232-0203	0232-0204
	FRONT	14X7	4/110	4+3	0230-0527	0232-0203	0232-0204
	REAR	14X8	4/110	4+4	0230-0532	0232-0203	0232-0204
	FRONT	15X7	4/110	4+3	0230-0535	0232-0203	0232-0204
	REAR	15X8	4/110	4+4	0230-0538	0232-0203	0232-0204
RHINO 450/660/700 04-13	FRONT	12X7	4/110	4+3	0230-0519	0232-0203	0232-0204
	REAR	12X8	4/110	4+4	0230-0524	0232-0203	0232-0204
	FRONT	14X7	4/110	4+3	0230-0527	0232-0203	0232-0204
	REAR	14X8	4/110	4+4	0230-0532	0232-0203	0232-0204

FITS MODEL	POSITION	SIZE	BOLT PATTERN	OFFSET	WHEEL PART #	LUG NUT CHROME (16-PK) PART #	LUG NUT BLACK (16-PK) PART #
393X ATV/UTV WHEELS (CON'T)							
YAMAHA (CON'T)							
RHINO 450/660/700 04-13 (CON'T)	FRONT	15X7	4/110	4+3	0230-0535	0232-0203	0232-0204
	REAR	15X8	4/110	4+4	0230-0538	0232-0203	0232-0204
WOLVERINE/YXZ1000 14-18	FRONT	12X7	4/110	4+3	0230-0519	0232-0207	0232-0208
	REAR	12X8	4/110	4+4	0230-0524	0232-0207	0232-0208
	FRONT	14X7	4/110	4+3	0230-0527	0232-0207	0232-0208
	REAR	14X8	4/110	4+4	0230-0532	0232-0207	0232-0208
	FRONT	15X7	4/110	4+3	0230-0535	0232-0207	0232-0208
	REAR	15X8	4/110	4+4	0230-0538	0232-0207	0232-0208

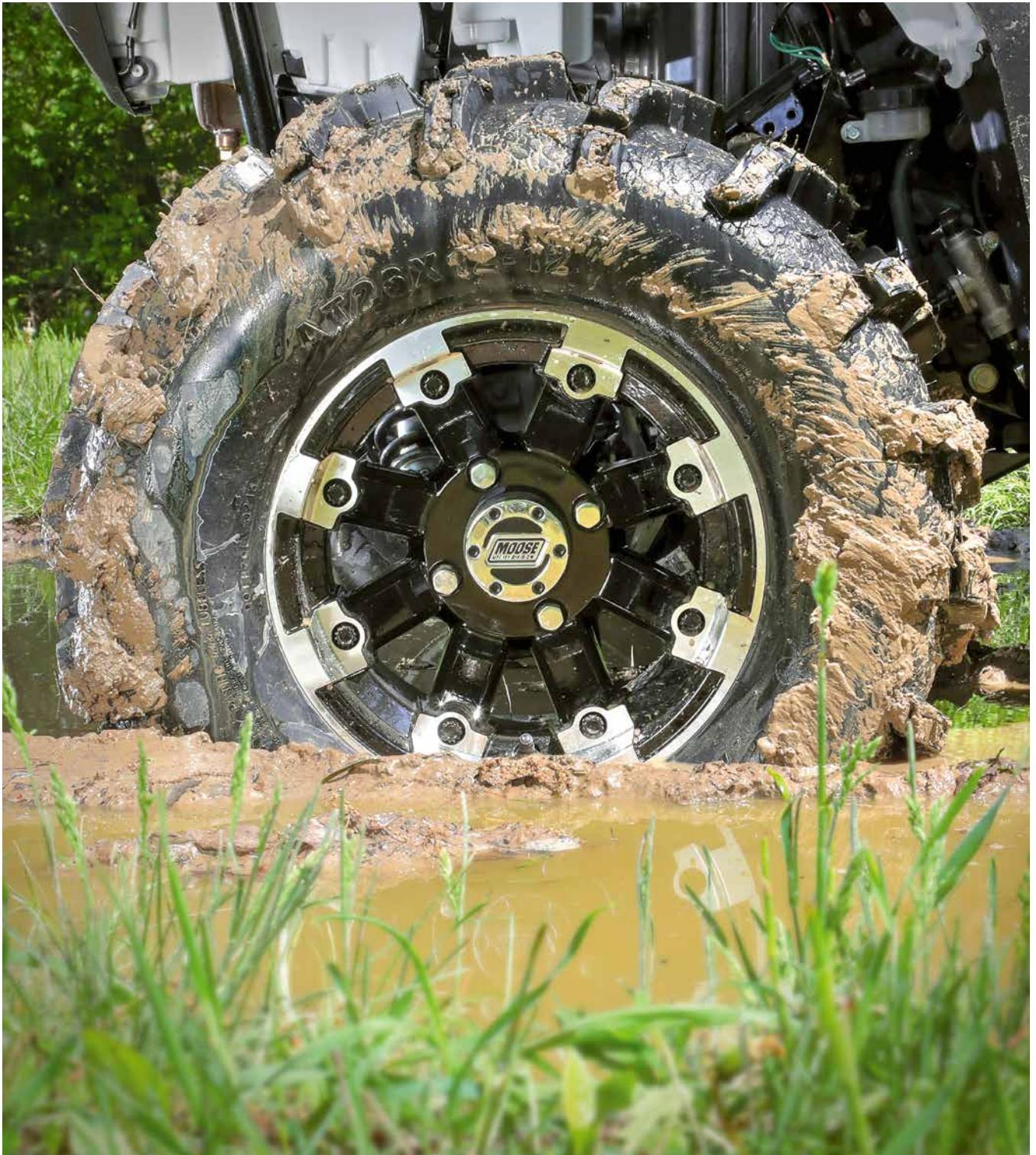





BLACK

MACHINED W/ BLACK

387X

387X ATV/UTV WHEELS

Built to meet the demands of the ATV/UTV market. Whether it is in the woods, deep mud or sand, the 387X is prepared to take it on. Handles load capacities from 675 lbs. for the 12x7 front to 1150 lbs. for the 12x8 rear which meet, or exceed all current market requirements. Separate yourself from the herd with a line of wheels that are 100% x-rayed on the production line to ensure quality and reliability. Available in gloss black or machined finish with chrome center caps and rivets. Center caps are included with each wheel (replacement center caps 0223-0113 for 4/110 bolt pattern, 0232-0210 for 4/136, 4/156 and 4/4 bolt patterns). Lug nuts must be ordered separately.



BLUE

RED

WHEELS & TIRES

FITS MODEL	POSITION	SIZE	BOLT PATTERN	OFFSET	MACHINED W/BLACK WHEEL PART #	BLACK WHEEL PART #	BLUE WHEEL PART #	RED WHEEL PART #	LUG NUT CHROME (16-PK) PART #	LUG NUT BLACK (16-PK) PART #
387X ATV/UTV WHEELS										
CAN-AM										
OUTLANDER 330/400/500/570/650/800/850/1000 03-19	FRONT	12X7	4/136	4+3	0230-0440	0230-0448	0230-0863	0230-0865	0232-0203	0232-0204
	REAR	12X8	4/136	4+4	0230-0445	0230-0453	0230-0864	0230-0866	0232-0203	0232-0204
	FRONT	14X7	4/136	4+3	0230-0456	0230-0464	0230-0867	0230-0869	0232-0203	0232-0204
	REAR	14X8	4/136	4+4	0230-0461	0230-0469	0230-0868	0230-0870	0232-0203	0232-0204
RENEGADE 500/570/800/850/1000 09-19	FRONT	12X7	4/136	4+3	0230-0440	0230-0448	0230-0863	0230-0865	0232-0203	0232-0204
	REAR	12X8	4/136	4+4	0230-0445	0230-0453	0230-0864	0230-0866	0232-0203	0232-0204
	FRONT	14X7	4/136	4+3	0230-0456	0230-0464	0230-0867	0230-0869	0232-0203	0232-0204
	REAR	14X8	4/136	4+4	0230-0461	0230-0469	0230-0868	0230-0870	0232-0203	0232-0204
TRAXTER 4X4 99-06	FRONT	12X7	4/110	4+3	0230-0624	0230-0626	-	-	0232-0203	0232-0204
	REAR	12X8	4/110	2+6	0230-0443	0230-0451	-	-	0232-0203	0232-0204
	FRONT	14X7	4/110	4+3	0230-0628	0230-0630	-	-	0232-0203	0232-0204
	REAR	14X8	4/110	2+6	0230-0459	-	-	-	0232-0203	0232-0204
QUEST 650 01-06	FRONT	12X7	4/110	4+3	0230-0624	0230-0626	-	-	0232-0203	0232-0204
	REAR	12X8	4/110	2+6	0230-0443	0230-0451	-	-	0232-0203	0232-0204
	FRONT	14X7	4/110	4+3	0230-0628	0230-0630	-	-	0232-0203	0232-0204
	REAR	14X8	4/110	2+6	0230-0459	-	-	-	0232-0203	0232-0204
MAVERICK/MAX 1000 14-19	FRONT	12X7	4/136	4+3	0230-0440	0230-0448	0230-0863	0230-0865	0232-0203	0232-0204
	REAR	12X8	4/136	4+4	0230-0445	0230-0453	0230-0864	0230-0866	0232-0203	0232-0204
	FRONT	14X7	4/136	4+3	0230-0456	0230-0464	0230-0867	0230-0869	0232-0203	0232-0204
	REAR	14X8	4/136	4+4	0230-0461	0230-0469	0230-0868	0230-0870	0232-0203	0232-0204
COMMANDER 800/1000 13-19	FRONT	12X7	4/136	4+3	0230-0440	0230-0448	0230-0863	0230-0865	0232-0203	0232-0204
	REAR	12X8	4/136	4+4	0230-0445	0230-0453	0230-0864	0230-0866	0232-0203	0232-0204
	FRONT	14X7	4/136	4+3	0230-0456	0230-0464	0230-0867	0230-0869	0232-0203	0232-0204
	REAR	14X8	4/136	4+4	0230-0461	0230-0469	0230-0868	0230-0870	0232-0203	0232-0204
DEFENDER 1000 16-19	FRONT	12X7	4/136	4+3	0230-0440	0230-0448	0230-0863	0230-0865	0232-0203	0232-0204
	REAR	12X8	4/136	4+4	0230-0445	0230-0453	0230-0864	0230-0866	0232-0203	0232-0204
	FRONT	14X7	4/136	4+3	0230-0456	0230-0464	0230-0867	0230-0869	0232-0203	0232-0204
	REAR	14X8	4/136	4+4	0230-0461	0230-0469	0230-0868	0230-0870	0232-0203	0232-0204
HONDA										
TRX250 RECON 08-12	FRONT	12X7	4/110	4+3	0230-0624	0230-0626	-	-	0232-0203	0232-0204
	REAR	12X8	4/110	2+6	0230-0443	0230-0451	-	-	0232-0203	0232-0204
TRX300 FOURTRAX 4X4 89-00	FRONT	12X7	4/110	4+3	0230-0624	0230-0626	-	-	0232-0203	0232-0204
	REAR	12X8	4/110	2+6	0230-0443	0230-0451	-	-	0232-0203	0232-0204
	FRONT	14X7	4/110	4+3	0230-0628	0230-0630	-	-	0232-0203	0232-0204
	REAR	14X8	4/110	2+6	0230-0459	-	-	-	0232-0203	0232-0204
TRX350 RANCHER S-ES 4X4 00-06	FRONT	12X7	4/110	4+3	0230-0624	0230-0626	-	-	0232-0203	0232-0204
	REAR	12X8	4/110	2+6	0230-0443	0230-0451	-	-	0232-0203	0232-0204
	FRONT	14X7	4/110	4+3	0230-0628	0230-0630	-	-	0232-0203	0232-0204
	REAR	14X8	4/110	2+6	0230-0459	-	-	-	0232-0203	0232-0204
TRX400/420 RANCHER 4X4 04-14	FRONT	12X7	4/110	4+3	0230-0624	0230-0626	-	-	0232-0203	0232-0204
	REAR	12X8	4/110	2+6	0230-0443	0230-0451	-	-	0232-0203	0232-0204
	FRONT	14X7	4/110	4+3	0230-0628	0230-0630	-	-	0232-0203	0232-0204
	REAR	14X8	4/110	2+6	0230-0459	-	-	-	0232-0203	0232-0204
TRX400 FOREMAN 4X4 96-06	FRONT	12X7	4/110	4+3	0230-0624	0230-0626	-	-	0232-0203	0232-0204
	REAR	12X8	4/110	2+6	0230-0443	0230-0451	-	-	0232-0203	0232-0204
	FRONT	14X7	4/110	4+3	0230-0628	0230-0630	-	-	0232-0203	0232-0204
	REAR	14X8	4/110	2+6	0230-0459	-	-	-	0232-0203	0232-0204
TRX450/500 FOREMAN S-ES 4X4 98-14	FRONT	12X7	4/110	4+3	0230-0624	0230-0626	-	-	0232-0203	0232-0204
	REAR	12X8	4/110	2+6	0230-0443	0230-0451	-	-	0232-0203	0232-0204
	FRONT	14X7	4/110	4+3	0230-0628	0230-0630	-	-	0232-0203	0232-0204
	REAR	14X8	4/110	2+6	0230-0459	-	-	-	0232-0203	0232-0204
TRX500 RUBICON 4X4 01-11	FRONT	12X7	4/110	4+3	0230-0624	0230-0626	-	-	0232-0203	0232-0204
	REAR	12X8	4/110	2+6	0230-0443	0230-0451	-	-	0232-0203	0232-0204
	FRONT	14X7	4/110	4+3	0230-0628	0230-0630	-	-	0232-0203	0232-0204
	REAR	14X8	4/110	2+6	0230-0459	-	-	-	0232-0203	0232-0204
TRX650/680 RINCON 4X4 02-19	FRONT	12X7	4/110	4+3	0230-0624	0230-0626	0230-0803	0230-0811	0232-0203	0232-0204
	REAR	12X8	4/110	4+4	0230-0625	0230-0627	0230-0804	0230-0812	0232-0203	0232-0204
	FRONT	14X7	4/110	4+3	0230-0628	0230-0630	0230-0807	0230-0815	0232-0203	0232-0204
	REAR	14X8	4/110	4+4	0230-0629	0230-0631	0230-0808	0230-0816	0232-0203	0232-0204
TRX420AT/500AT RANCHER 09-19	FRONT	12X7	4/110	4+3	0230-0624	0230-0626	0230-0803	0230-0811	0232-0203	0232-0204
	REAR	12X8	4/110	4+4	0230-0625	0230-0627	0230-0804	0230-0812	0232-0203	0232-0204
	FRONT	14X7	4/110	4+3	0230-0628	0230-0630	0230-0807	0230-0815	0232-0203	0232-0204
	REAR	14X8	4/110	4+4	0230-0629	0230-0631	0230-0808	0230-0816	0232-0203	0232-0204
BIG RED 700 MUV 09-13	FRONT	12X7	4/110	4+3	0230-0624	0230-0626	0230-0803	0230-0811	0232-0209	-
	REAR	12X8	4/110	4+4	0230-0625	0230-0627	0230-0804	0230-0812	0232-0209	-
	FRONT	14X7	4/110	4+3	0230-0628	0230-0630	0230-0807	0230-0815	0232-0209	-
	REAR	14X8	4/110	4+4	0230-0629	0230-0631	0230-0808	0230-0816	0232-0209	-
WPIONEER 500/700 14-19	FRONT	12X7	4/110	4+3	0230-0624	0230-0626	0230-0803	0230-0811	0232-0209	-
	REAR	12X8	4/110	4+4	0230-0625	0230-0627	0230-0804	0230-0812	0232-0209	-
	FRONT	14X7	4/110	4+3	0230-0628	0230-0630	0230-0807	0230-0815	0232-0209	-
	REAR	14X8	4/110	4+4	0230-0629	0230-0631	0230-0808	0230-0816	0232-0209	-

FITS MODEL	POSITION	SIZE	BOLT PATTERN	OFFSET	MACHINED W/BLACK WHEEL PART #	BLACK WHEEL PART #	BLUE WHEEL PART #	RED WHEEL PART #	LUG NUT CHROME (16-PK) PART #	LUG NUT BLACK (16-PK) PART #	
387X ATV/UTV WHEELS (CON'T)											
HONDA (CON'T)											
PIONEER 1000 16-19	FRONT	12X7	4/136	4+3	0230-0440	0230-0448	0230-0863	0230-0865	0232-0209	-	
	REAR	12X8	4/136	4+4	0230-0445	0230-0453	0230-0864	0230-0866	0232-0209	-	
	FRONT	14X7	4/136	4+3	0230-0456	0230-0464	0230-0867	0230-0869	0232-0209	-	
	REAR	14X8	4/136	4+4	0230-0461	0230-0469	0230-0868	0230-0870	0232-0209	-	
KAWASAKI											
BRUTE FORCE 650I 4X4 06-18 (IRS MODEL)	FRONT	12X7	4/110	4+3	0230-0624	0230-0626	0230-0803	0230-0811	0232-0203	0232-0204	
	REAR	12X8	4/110	4+4	0230-0625	0230-0627	0230-0804	0230-0812	0232-0203	0232-0204	
	FRONT	14X7	4/110	4+3	0230-0628	0230-0630	0230-0807	0230-0815	0232-0203	0232-0204	
	REAR	14X8	4/110	4+4	0230-0629	0230-0631	0230-0808	0230-0816	0232-0203	0232-0204	
BRUTE FORCE 750 4X4 05-19 (IRS)	FRONT	12X7	4/110	4+3	0230-0624	0230-0626	0230-0803	0230-0811	0232-0203	0232-0204	
	REAR	12X8	4/110	4+4	0230-0625	0230-0627	0230-0804	0230-0812	0232-0203	0232-0204	
	FRONT	14X7	4/110	4+3	0230-0628	0230-0630	0230-0807	0230-0815	0232-0203	0232-0204	
	REAR	14X8	4/110	4+4	0230-0629	0230-0631	0230-0808	0230-0816	0232-0203	0232-0204	
TERYX 750/800 08-19	FRONT	12X7	4/136	4+3	0230-0440	0230-0448	0230-0863	0230-0865	0232-0207	0232-0208	
	REAR	12X8	4/136	4+4	0230-0445	0230-0453	0230-0864	0230-0866	0232-0207	0232-0208	
	FRONT	14X7	4/136	4+3	0230-0456	0230-0464	0230-0867	0230-0869	0232-0207	0232-0208	
	REAR	14X8	4/136	4+4	0230-0461	0230-0469	0230-0868	0230-0870	0232-0207	0232-0208	
MULE 2500/3000/4010 SERIES ALL * LIFT KIT NEEDED FOR 66 CM (26") OR LARGER TIRES	FRONT	12X7	4/136	4+3	0230-0440	0230-0448	0230-0863	0230-0865	0232-0207	0232-0208	
	REAR	12X8	4/136	4+4	0230-0445	0230-0453	0230-0864	0230-0866	0232-0207	0232-0208	
	FRONT	14X7	4/136	4+3	0230-0456	0230-0464	0230-0867	0230-0869	0232-0207	0232-0208	
	REAR	14X8	4/136	4+4	0230-0461	0230-0469	0230-0868	0230-0870	0232-0207	0232-0208	
MULE PRO FXT 15-19	FRONT	12X7	4/156	4+3	0230-0439	0230-0447	0230-0805	0230-0813	0232-0207	0232-0208	
	REAR	12X8	4/156	4+4	0230-0444	0230-0452	0230-0806	0230-0814	0232-0207	0232-0208	
	FRONT	14X7	4/156	4+3	0230-0455	0230-0463	0230-0809	0230-0817	0232-0207	0232-0208	
	REAR	14X8	4/156	4+4	0230-0460	0230-0468	0230-0810	0230-0818	0232-0207	0232-0208	
KYMCO											
500MUX SA 08-10/MXU 1E 08-11/500 UXV 10-14	FRONT	12X7	4/110	4+3	0230-0624	0230-0626	0230-0803	0230-0811	0232-0203	0232-0204	
	REAR	12X8	4/110	4+4	0230-0625	0230-0627	0230-0804	0230-0812	0232-0203	0232-0204	
375/500/700 MXU-1E15-18	FRONT	12X7	4/110	4+3	0230-0624	0230-0626	0230-0803	0230-0811	0232-0203	0232-0204	
450/500/700 UXV 08-18	FRONT	12X7	4/110	4+3	0230-0624	0230-0626	0230-0803	0230-0811	0232-0203	0232-0204	
	REAR	12X8	4/110	4+4	0230-0625	0230-0627	0230-0804	0230-0812	0232-0203	0232-0204	
POLARIS											
SPORTSMAN 335 99-06	FRONT	12X7	4/156	4+3	0230-0439	0230-0447	0230-0805	0230-0813	0232-0205	0232-0206	
	REAR	12X8	4/156	4+4	0230-0444	0230-0452	0230-0806	0230-0814	0232-0205	0232-0206	
	FRONT	14X7	4/156	4+3	0230-0455	0230-0463	0230-0809	0230-0817	0232-0205	0232-0206	
	REAR	14X8	4/156	4+4	0230-0460	0230-0468	0230-0810	0230-0818	0232-0205	0232-0206	
SPORTSMAN 400/450 01-13	FRONT	12X7	4/156	4+3	0230-0439	0230-0447	0230-0805	0230-0813	0232-0205	0232-0206	
	REAR	12X8	4/156	4+4	0230-0444	0230-0452	0230-0806	0230-0814	0232-0205	0232-0206	
	FRONT	14X7	4/156	4+3	0230-0455	0230-0463	0230-0809	0230-0817	0232-0205	0232-0206	
	REAR	14X8	4/156	4+4	0230-0460	0230-0468	0230-0810	0230-0818	0232-0205	0232-0206	
SPORTSMAN 500 96-13	FRONT	12X7	4/156	4+3	0230-0439	0230-0447	0230-0805	0230-0813	0232-0205	0232-0206	
	REAR	12X8	4/156	4+4	0230-0444	0230-0452	0230-0806	0230-0814	0232-0205	0232-0206	
	FRONT	14X7	4/156	4+3	0230-0455	0230-0463	0230-0809	0230-0817	0232-0205	0232-0206	
	REAR	14X8	4/156	4+4	0230-0460	0230-0468	0230-0810	0230-0818	0232-0205	0232-0206	
MAGNUM 500 02-06	FRONT	12X7	4/156	4+3	0230-0439	0230-0447	0230-0805	0230-0813	0232-0205	0232-0206	
	REAR	12X8	4/156	4+4	0230-0444	0230-0452	0230-0806	0230-0814	0232-0205	0232-0206	
	FRONT	14X7	4/156	4+3	0230-0455	0230-0463	0230-0809	0230-0817	0232-0205	0232-0206	
	REAR	14X8	4/156	4+4	0230-0460	0230-0468	0230-0810	0230-0818	0232-0205	0232-0206	
SPORTSMAN 570 14-13	FRONT	12X7	4/156	4+3	0230-0439	0230-0447	0230-0805	0230-0813	0232-0205	0232-0206	
	REAR	12X8	4/156	4+4	0230-0444	0230-0452	0230-0806	0230-0814	0232-0205	0232-0206	
	FRONT	14X7	4/156	4+3	0230-0455	0230-0463	0230-0809	0230-0817	0232-0205	0232-0206	
	REAR	14X8	4/156	4+4	0230-0460	0230-0468	0230-0810	0230-0818	0232-0205	0232-0206	
SPORTSMAN 600 03-08	FRONT	12X7	4/156	4+3	0230-0439	0230-0447	0230-0805	0230-0813	0232-0205	0232-0206	
	REAR	12X8	4/156	4+4	0230-0444	0230-0452	0230-0806	0230-0814	0232-0205	0232-0206	
	FRONT	14X7	4/156	4+3	0230-0455	0230-0463	0230-0809	0230-0817	0232-0205	0232-0206	
	REAR	14X8	4/156	4+4	0230-0460	0230-0468	0230-0810	0230-0818	0232-0205	0232-0206	
SPORTSMAN 700 02-09	FRONT	12X7	4/156	4+3	0230-0439	0230-0447	0230-0805	0230-0813	0232-0205	0232-0206	
	REAR	12X8	4/156	4+4	0230-0444	0230-0452	0230-0806	0230-0814	0232-0205	0232-0206	
	FRONT	14X7	4/156	4+3	0230-0455	0230-0463	0230-0809	0230-0817	0232-0205	0232-0206	
	REAR	14X8	4/156	4+4	0230-0460	0230-0468	0230-0810	0230-0818	0232-0205	0232-0206	
SPORTSMAN 800 05-14	FRONT	12X7	4/156	4+3	0230-0439	0230-0447	0230-0805	0230-0813	0232-0205	0232-0206	
	REAR	12X8	4/156	4+4	0230-0444	0230-0452	0230-0806	0230-0814	0232-0205	0232-0206	
	FRONT	14X7	4/156	4+3	0230-0455	0230-0463	0230-0809	0230-0817	0232-0205	0232-0206	
	REAR	14X8	4/156	4+4	0230-0460	0230-0468	0230-0810	0230-0818	0232-0205	0232-0206	
RANGER ETX/570/EV/ 800 6X6 4X4 03-19	FRONT	12X7	4/156	4+3	0230-0439	0230-0447	0230-0805	0230-0813	0232-0205	0232-0206	
	REAR	12X8	4/156	4+4	0230-0444	0230-0452	0230-0806	0230-0814	0232-0205	0232-0206	
	FRONT	14X7	4/156	4+3	0230-0455	0230-0463	0230-0809	0230-0817	0232-0205	0232-0206	
	REAR	14X8	4/156	4+4	0230-0460	0230-0468	0230-0810	0230-0818	0232-0205	0232-0206	
RANGER XP900 & DIESEL 14-19	FRONT	12X7	4/156	4+3	0230-0439	0230-0447	0230-0805	0230-0813	0232-0209	-	
	REAR	12X8	4/156	4+4	0230-0444	0230-0452	0230-0806	0230-0814	0232-0209	-	
	FRONT	14X7	4/156	4+3	0230-0455	0230-0463	0230-0809	0230-0817	0232-0209	-	
	REAR	14X8	4/156	4+4	0230-0460	0230-0468	0230-0810	0230-0818	0232-0209	-	

PLOWES
WINCHES
UTV
RACKS
IMPLEMENT & TOWING
LUGGAGE
BODY
CONTROLS
ELECTRICAL
WHEELS & TIRES
SUSPENSION & DRIVE
BRAKING
ENGINE
RIDER
GARAGE
PROMO

WHEELS & TIRES

FITS MODEL	POSITION	SIZE	BOLT PATTERN	OFFSET	MACHINED W/BLACK WHEEL PART #	BLACK WHEEL PART #	BLUE WHEEL PART #	RED WHEEL PART #	LUG NUT CHROME (16-PK) PART #	LUG NUT BLACK (16-PK) PART #
387X ATV/UTV WHEELS (CON'T)										
POLARIS (CON'T)										
SPORTSMAN ACE 570/900 14-19	FRONT	12X7	4/156	4+3	0230-0439	0230-0447	0230-0805	0230-0813	0232-0205	0232-0206
	REAR	12X8	4/156	4+4	0230-0444	0230-0452	0230-0806	0230-0814	0232-0205	0232-0206
	FRONT	14X7	4/156	4+3	0230-0455	0230-0463	0230-0809	0230-0817	0232-0205	0232-0206
	REAR	14X8	4/156	4+4	0230-0460	0230-0468	0230-0810	0230-0818	0232-0205	0232-0206
SPORTSMAN XP 550/700/800/850 09-19	FRONT	12X7	4/156	4+3	0230-0439	0230-0447	0230-0805	0230-0813	0232-0203	0232-0204
	REAR	12X8	4/156	4+4	0230-0444	0230-0452	0230-0806	0230-0814	0232-0203	0232-0204
* SPORTSMAN XP 2009 IS 12.5 CM (5") WIDER W/ AFTER MARKET WHEELS	FRONT	14X7	4/156	4+3	0230-0455	0230-0463	0230-0809	0230-0817	0232-0203	0232-0204
	REAR	14X8	4/156	4+4	0230-0460	0230-0468	0230-0810	0230-0818	0232-0203	0232-0204
	FRONT	12X7	4/156	4+3	0230-0439	0230-0447	0230-0805	0230-0813	0232-0205	0232-0206
SPORTSMAN X2 500/550/800 09-15	FRONT	12X7	4/156	4+3	0230-0439	0230-0447	0230-0805	0230-0813	0232-0205	0232-0206
	REAR	12X8	4/156	4+4	0230-0444	0230-0452	0230-0806	0230-0814	0232-0205	0232-0206
	FRONT	14X7	4/156	4+3	0230-0455	0230-0463	0230-0809	0230-0817	0232-0205	0232-0206
	REAR	14X8	4/156	4+4	0230-0460	0230-0468	0230-0810	0230-0818	0232-0205	0232-0206
RZR 800/900XP 08-14 & RZR 570 14-19	FRONT	12X7	4/156	4+3	0230-0439	0230-0447	0230-0805	0230-0813	0232-0205	0232-0206
	REAR	12X8	4/156	4+4	0230-0444	0230-0452	0230-0806	0230-0814	0232-0205	0232-0206
	FRONT	14X7	4/156	4+3	0230-0455	0230-0463	0230-0809	0230-0817	0232-0205	0232-0206
	REAR	14X8	4/156	4+4	0230-0460	0230-0468	0230-0810	0230-0818	0232-0205	0232-0206
RZR 900/900 XC/900 S 15-19	FRONT	12X7	4/156	4+3	0230-0439	0230-0447	0230-0805	0230-0813	0232-0209	-
	REAR	12X8	4/156	4+4	0230-0444	0230-0452	0230-0806	0230-0814	0232-0209	-
	FRONT	14X7	4/156	4+3	0230-0455	0230-0463	0230-0809	0230-0817	0232-0209	-
	REAR	14X8	4/156	4+4	0230-0460	0230-0468	0230-0810	0230-0818	0232-0209	-
RZR 1000 XP / 4 14-19	FRONT	12X7	4/156	4+3	0230-0439	0230-0447	0230-0805	0230-0813	0232-0209	-
	REAR	12X8	4/156	4+4	0230-0444	0230-0452	0230-0806	0230-0814	0232-0209	-
	FRONT	14X7	4/156	4+3	0230-0455	0230-0463	0230-0809	0230-0817	0232-0209	-
	REAR	14X8	4/156	4+4	0230-0460	0230-0468	0230-0810	0230-0818	0232-0209	-
GENERAL 17-19	FRONT	12X7	4/156	4+3	0230-0439	0230-0447	0230-0805	0230-0813	0232-0209	-
	REAR	12X8	4/156	4+4	0230-0444	0230-0452	0230-0806	0230-0814	0232-0209	-
	FRONT	14X7	4/156	4+3	0230-0455	0230-0463	0230-0809	0230-0817	0232-0209	-
	REAR	14X8	4/156	4+4	0230-0460	0230-0468	0230-0810	0230-0818	0232-0209	-
SUZUKI										
KING QUAD 400 (STRAIGHT AXLE) 4X4 08-14	FRONT	12X7	4/110	4+3	0230-0624	0230-0626	-	-	0232-0203	0232-0204
	REAR	12X8	4/110	2+6	0230-0443	0230-0451	-	-	0232-0203	0232-0204
	FRONT	14X7	4/110	4+3	0230-0628	0230-0630	-	-	0232-0203	0232-0204
	REAR	14X8	4/110	2+6	0230-0459	-	-	-	0232-0203	0232-0204
VINSON 500 4X4 02-08	FRONT	12X7	4/110	4+3	0230-0624	0230-0626	-	-	0232-0203	0232-0204
	REAR	12X8	4/110	2+6	0230-0443	0230-0451	-	-	0232-0203	0232-0204
	FRONT	14X7	4/110	4+3	0230-0628	0230-0630	-	-	0232-0203	0232-0204
	REAR	14X8	4/110	2+6	0230-0459	-	-	-	0232-0203	0232-0204
EIGER 400 4X4 02-07	FRONT	12X7	4/110	4+3	0230-0624	0230-0626	-	-	0232-0203	0232-0204
	REAR	12X8	4/110	2+6	0230-0443	0230-0451	-	-	0232-0203	0232-0204
	FRONT	14X7	4/110	4+3	0230-0628	0230-0630	-	-	0232-0203	0232-0204
	REAR	14X8	4/110	2+6	0230-0459	-	-	-	0232-0203	0232-0204
KING QUAD 450/700/750 05-19	FRONT	12X7	4/110	4+3	0230-0624	0230-0626	0230-0803	0230-0811	0232-0203	0232-0204
	REAR	12X8	4/110	4+4	0230-0625	0230-0627	0230-0804	0230-0812	0232-0203	0232-0204
	FRONT	14X7	4/110	4+3	0230-0628	0230-0630	0230-0807	0230-0815	0232-0203	0232-0204
	REAR	14X8	4/110	4+4	0230-0629	0230-0631	0230-0808	0230-0816	0232-0203	0232-0204
YAMAHA										
GRIZZLY 350 (STRAIGHT AXLE) 4X4 08-12	FRONT	12X7	4/110	4+3	0230-0624	0230-0626	-	-	0232-0203	0232-0204
	REAR	12X8	4/110	2+6	0230-0443	0230-0451	-	-	0232-0203	0232-0204
	FRONT	14X7	4/110	4+3	0230-0628	0230-0630	-	-	0232-0203	0232-0204
	REAR	14X8	4/110	2+6	0230-0459	-	-	-	0232-0203	0232-0204
BIG BEAR 350/400 2X4/4X4 87-06	FRONT	12X7	4/110	4+3	0230-0624	0230-0626	-	-	0232-0203	0232-0204
	REAR	12X8	4/110	2+6	0230-0443	0230-0451	-	-	0232-0203	0232-0204
	FRONT	14X7	4/110	4+3	0230-0628	0230-0630	-	-	0232-0203	0232-0204
	REAR	14X8	4/110	2+6	0230-0459	-	-	-	0232-0203	0232-0204
WOLVERINE 350/450 4X4 95-08	FRONT	12X7	4/110	4+3	0230-0624	0230-0626	-	-	0232-0203	0232-0204
	REAR	12X8	4/110	2+6	0230-0443	0230-0451	-	-	0232-0203	0232-0204
	FRONT	14X7	4/110	4+3	0230-0628	0230-0630	-	-	0232-0203	0232-0204
	REAR	14X8	4/110	2+6	0230-0459	-	-	-	0232-0203	0232-0204
BRUIN 350 2X4/4X4 04-06	FRONT	12X7	4/110	4+3	0230-0624	0230-0626	-	-	0232-0203	0232-0204
	REAR	12X8	4/110	2+6	0230-0443	0230-0451	-	-	0232-0203	0232-0204
	FRONT	14X7	4/110	4+3	0230-0628	0230-0630	-	-	0232-0203	0232-0204
	REAR	14X8	4/110	2+6	0230-0459	-	-	-	0232-0203	0232-0204
GRIZZLY 350 IRS 07-15	FRONT	12X7	4/110	4+3	0230-0624	0230-0626	0230-0803	0230-0811	0232-0203	0232-0204
	REAR	12X8	4/110	4+4	0230-0625	0230-0627	0230-0804	0230-0812	0232-0203	0232-0204
	FRONT	14X7	4/110	4+3	0230-0628	0230-0630	0230-0807	0230-0815	0232-0203	0232-0204
	REAR	14X8	4/110	4+4	0230-0629	0230-0631	0230-0808	0230-0816	0232-0203	0232-0204
KODIAK 400/450 4X4 93-04	FRONT	12X7	4/110	4+3	0230-0624	0230-0626	-	-	0232-0203	0232-0204
	REAR	12X8	4/110	2+6	0230-0443	0230-0451	-	-	0232-0203	0232-0204
	FRONT	14X7	4/110	4+3	0230-0628	0230-0630	-	-	0232-0203	0232-0204
	REAR	14X8	4/110	2+6	0230-0459	-	-	-	0232-0203	0232-0204
GRIZZLY 600 98-01	FRONT	12X7	4/110	4+3	0230-0624	0230-0626	-	-	0232-0203	0232-0204
	REAR	12X8	4/110	2+6	0230-0443	0230-0451	-	-	0232-0203	0232-0204
	FRONT	14X7	4/110	4+3	0230-0628	0230-0630	-	-	0232-0203	0232-0204

FITS MODEL	POSITION	SIZE	BOLT PATTERN	OFFSET	MACHINED W/BLACK WHEEL PART #	BLACK WHEEL PART #	BLUE WHEEL PART #	RED WHEEL PART #	LUG NUT CHROME (16-PK) PART #	LUG NUT BLACK (16-PK) PART #
387X ATV/UTV WHEELS (CON'T)										
YAMAHA (CON'T)										
GRIZZLY 600 98-01 (CON'T)	REAR	14X8	4/110	2+6	0230-0459	-	-	-	0232-0203	0232-0204
KODIAK 400/450 4X4 05-06	FRONT	12X7	4/110	4+3	0230-0624	0230-0626	0230-0803	0230-0811	0232-0203	0232-0204
	REAR	12X8	4/110	4+4	0230-0625	0230-0627	0230-0804	0230-0812	0232-0203	0232-0204
	FRONT	14X7	4/110	4+3	0230-0628	0230-0630	0230-0807	0230-0815	0232-0203	0232-0204
	REAR	14X8	4/110	4+4	0230-0629	0230-0631	0230-0808	0230-0816	0232-0203	0232-0204
GRIZZLY 400/450/550/700 4X4 07-19	FRONT	12X7	4/110	4+3	0230-0624	0230-0626	0230-0803	0230-0811	0232-0203	0232-0204
	REAR	12X8	4/110	4+4	0230-0625	0230-0627	0230-0804	0230-0812	0232-0203	0232-0204
	FRONT	14X7	4/110	4+3	0230-0628	0230-0630	0230-0807	0230-0815	0232-0203	0232-0204
	REAR	14X8	4/110	4+4	0230-0629	0230-0631	0230-0808	0230-0816	0232-0203	0232-0204
BIG BEAR 400 IRS 07-12	FRONT	12X7	4/110	4+3	0230-0624	0230-0626	0230-0803	0230-0811	0232-0203	0232-0204
	REAR	12X8	4/110	4+4	0230-0625	0230-0627	0230-0804	0230-0812	0232-0203	0232-0204
	FRONT	14X7	4/110	4+3	0230-0628	0230-0630	0230-0807	0230-0815	0232-0203	0232-0204
	REAR	14X8	4/110	4+4	0230-0629	0230-0631	0230-0808	0230-0816	0232-0203	0232-0204
GRIZZLY 660 02-09	FRONT	12X7	4/110	4+3	0230-0624	0230-0626	0230-0803	0230-0811	0232-0203	0232-0204
	REAR	12X8	4/110	4+4	0230-0625	0230-0627	0230-0804	0230-0812	0232-0203	0232-0204
	FRONT	14X7	4/110	4+3	0230-0628	0230-0630	0230-0807	0230-0815	0232-0203	0232-0204
	REAR	14X8	4/110	4+4	0230-0629	0230-0631	0230-0808	0230-0816	0232-0203	0232-0204
RHINO 450/660/700 04-13	FRONT	12X7	4/110	4+3	0230-0624	0230-0626	0230-0803	0230-0811	0232-0203	0232-0204
	REAR	12X8	4/110	4+4	0230-0625	0230-0627	0230-0804	0230-0812	0232-0203	0232-0204
	FRONT	14X7	4/110	4+3	0230-0628	0230-0630	0230-0807	0230-0815	0232-0203	0232-0204
	REAR	14X8	4/110	4+4	0230-0629	0230-0631	0230-0808	0230-0816	0232-0203	0232-0204
VIKING 14-19	FRONT	12X7	4/110	4+3	0230-0624	0230-0626	0230-0803	0230-0811	0232-0207	0232-0208
	REAR	12X8	4/110	4+4	0230-0625	0230-0627	0230-0804	0230-0812	0232-0207	0232-0208
	FRONT	14X7	4/110	4+3	0230-0628	0230-0630	0230-0807	0230-0815	0232-0207	0232-0208
	REAR	14X8	4/110	4+4	0230-0629	0230-0631	0230-0808	0230-0816	0232-0207	0232-0208
WOLVERINE 16-19	FRONT	12X7	4/110	4+3	0230-0624	0230-0626	0230-0803	0230-0811	0232-0207	0232-0208
	REAR	12X8	4/110	4+4	0230-0625	0230-0627	0230-0804	0230-0812	0232-0207	0232-0208
	FRONT	14X7	4/110	4+3	0230-0628	0230-0630	0230-0807	0230-0815	0232-0207	0232-0208
	REAR	14X8	4/110	4+4	0230-0629	0230-0631	0230-0808	0230-0816	0232-0207	0232-0208
XYZ 1000R 16-18	FRONT	14X7	4/110	4+3	0230-0628	0230-0630	0230-0807	0230-0815	0232-0207	0232-0208
	REAR	14X8	4/110	4+4	0230-0629	0230-0631	0230-0808	0230-0816	0232-0207	0232-0208



PLOWS
WINCHES
UTV
RACKS
IMPLEMENT & TOWING
LUGGAGE
BODY
CONTROLS
ELECTRICAL
WHEELS & TIRES
SUSPENSION & DRIVE
BRAKING
ENGINE
RIDER
GARAGE
PROMO

WHEELS & TIRES



0213-0781



0213-0767



0213-0734

WHEEL STUD AND NUT KITS

Kit includes components to rebuild one wheel. Includes wheel studs, nuts, washers, and other miscellaneous components.

FITS MODEL	WHEEL STUD & NUT KIT FRONT #	WHEEL STUD & NUT KIT REAR #	WHEEL STUD & NUT KIT LEFT REAR #	WHEEL STUD & NUT KIT RIGHT REAR #
WHEEL STUD AND NUT KITS				
ARCTIC CAT				
150 UTILITY 09-17	-	0213-0755	-	-
250 2X4 03	-	0213-0784	-	-
250 2X4 04-05	0213-0784	0213-0784	-	-
250 2X4 06-09	0213-0755	0213-0755	-	-
250 4X4 03-05	0213-0784	0213-0784	-	-
300 2X4 03-04	0213-0784	0213-0784	-	-
300 2X4 10-16	0213-0755	0213-0755	-	-
300 4X4 03-05	0213-0784	0213-0784	-	-
350 CR 12	0213-0784	0213-0784	-	-
350 UTILITY 4X4 11	0213-0784	0213-0784	-	-
366 FIS W/AT 08-11	0213-0784	0213-0784	-	-
400 4X4 14-15	0213-0784	0213-0784	-	-
400 4X4 W/AT 03-04	0213-0784	0213-0784	-	-
400 4X4 W/MT 03	0213-0784	-	-	-
400 4X4 W/MT 04	0213-0784	0213-0784	-	-
400 DVX 04-08	0213-0750	0213-0752	-	-
400 FIS 2X4 W/AT 03	-	0213-0784	-	-
400 FIS 2X4 W/AT 04	0213-0784	0213-0784	-	-
400 FIS 2X4 W/MT 03	-	0213-0784	-	-
400 FIS 2X4 W/MT 04	0213-0784	0213-0784	-	-
400 FIS 4X4 TRV 06-14	0213-0784	0213-0784	-	-
400 FIS 4X4 W/AT 03-14	0213-0784	0213-0784	-	-
400 FIS 4X4 W/MT 02-08	0213-0784	0213-0784	-	-
400 TBX 4X4 04-06	0213-0784	0213-0784	-	-
400 VP 4X4 W/AT 05-06	0213-0784	0213-0784	-	-
400 VP 4X4 W/MT 05-06	0213-0784	0213-0784	-	-
ALTERRA 400 16-17	0213-0784	0213-0784	-	-
425 4X4 11	0213-0784	0213-0784	-	-
450 4X4 14-15	0213-0784	0213-0784	-	-
450 HI 10	0213-0784	0213-0784	-	-
450 HI 11	0213-0785	0213-0785	-	-
450 TRV 12	0213-0784	0213-0784	-	-
450I EFI 12	0213-0785	0213-0785	-	-
450I TRV EFI 11-12	0213-0784	0213-0784	-	-
450I TRV GT EFI 12	0213-0785	0213-0785	-	-
ALTERRA 450 16	0213-0784	0213-0784	-	-
500 EFI 4X4 W/AT 13-17	0213-0784	0213-0784	-	-
500 FIS 4X4 W/AT 02-03	0213-0784	-	-	-
500 FIS 4X4 W/AT 04-09	0213-0784	0213-0784	-	-
500 FIS 4X4 W/MT 03	0213-0784	-	-	-
500 FIS 4X4 W/MT 04-09	0213-0784	0213-0784	-	-
500 FIS TBX 4X4 03-06	0213-0784	0213-0784	-	-
500 FIS TRV 4X4 03-08	0213-0784	0213-0784	-	-
500 TRV 13-15	0213-0784	0213-0784	-	-
500 XR 15	0213-0784	0213-0784	-	-
ALTERRA 500 17	0213-0784	0213-0784	-	-
ALTERRA TRV 500 17	0213-0784	0213-0784	-	-
PROWLER 500 HDX 14-15	0213-0784	0213-0784	-	-
PROWLER 500 HDX XT 17	0213-0785	0213-0785	-	-
550 EFI 4X4 12-13	0213-0784	0213-0784	-	-
550 GT EFI 4X4 12	0213-0785	0213-0785	-	-
550 TRV 4X4 W/AT 09-11	0213-0784	0213-0784	-	-
550 TRV 4X4 W/AT 12-13	0213-0785	0213-0785	-	-
550 TRV XT/LTD 14-15	0213-0785	0213-0785	-	-
550 XT EFI 4X4 13	0213-0785	0213-0785	-	-
550 XT LTD EFI 12-13	0213-0785	0213-0785	-	-
550 XT LTD EFI 14	0213-0784	0213-0784	-	-
ALTERRA 550 16	0213-0784	0213-0784	-	-
PROWLER 550 09	0213-0784	0213-0784	-	-
PROWLER 550 10-15	0213-0785	0213-0785	-	-

FITS MODEL	WHEEL STUD & NUT KIT FRONT #	WHEEL STUD & NUT KIT REAR #	WHEEL STUD & NUT KIT LEFT REAR #	WHEEL STUD & NUT KIT RIGHT REAR #
WHEEL STUD AND NUT KITS (CON'T)				
ARCTIC CAT (CON'T)				
650 4X4 HI 06-11	0213-0784	0213-0784	-	-
650 4X4 HI MUD PRO 10-11	0213-0784	0213-0784	-	-
650 4X4 W/AT V2 04-06	0213-0784	0213-0784	-	-
650 HI TBX 07-09	0213-0784	0213-0784	-	-
650I 4X4 12	0213-0784	0213-0784	-	-
PROWLER 650 07	0213-0784	0213-0784	-	-
PROWLER 650 XT 06-09	0213-0785	0213-0785	-	-
700 AT EFI 06	0213-0785	0213-0785	-	-
700 DIESEL 07-15	0213-0784	0213-0784	-	-
700 EFI 07	0213-0785	0213-0785	-	-
700 EFI 08	0213-0784	0213-0784	-	-
700 EFI / LTD 11-13	0213-0785	0213-0785	-	-
700 EFI HI 08	0213-0785	0213-0785	-	-
700 EFI HI 09-10	0213-0784	0213-0784	-	-
700 EFI HI 11	0213-0785	0213-0785	-	-
700 EFI HI MUDPRO 09-11	0213-0785	0213-0785	-	-
700 GT EFI 12	0213-0785	0213-0785	-	-
700 LTD EFI 13	0213-0785	0213-0785	-	-
700 TBX 10	0213-0784	0213-0784	-	-
700 TBX 11-13	0213-0785	0213-0785	-	-
700 TBX 14-17	0213-0784	0213-0784	-	-
700 TRV 08-15	0213-0785	0213-0785	-	-
700 XT 13-14	0213-0785	0213-0785	-	-
700I EFI MUDPRO / LTD 12-15	0213-0785	0213-0785	-	-
700I HI TRV GT EFI 11-12	0213-0785	0213-0785	-	-
ALTERRA 700 16-17	0213-0784	0213-0784	-	-
PROWLER 700 HDX 12-14	0213-0785	0213-0785	-	-
PROWLER 700 HDX XT 15-17	0213-0785	0213-0785	-	-
PROWLER 700 XT 09-17	0213-0785	0213-0785	-	-
PROWLER 700 XTX 08-14	0213-0785	0213-0785	-	-
WILDCAT SPORT 15	-	0213-0784	-	-
WILDCAT TRAIL 17	0213-0784	0213-0784	-	-
WILDCAT TRAIL / XT 14-15	0213-0785	0213-0785	-	-
1000 LTD MUDPRO 15	0213-0785	0213-0785	-	-
1000 TRV 13	0213-0785	0213-0785	-	-
1000 TRV / CRUISER 09-12	0213-0785	0213-0785	-	-
1000 TRV GT 12	0213-0785	0213-0785	-	-
1000 TRV XT/LTD 15	0213-0785	0213-0785	-	-
1000 XT 13-17	0213-0785	0213-0785	-	-
1000I GT 12	0213-0785	0213-0785	-	-
1000I LTD EFI MUDPRO 12-14	0213-0785	0213-0785	-	-
H2 MUDPRO 10-11	0213-0785	0213-0785	-	-
H2 THUNDERCAT 08-10	0213-0785	0213-0785	-	-
PROWLER 1000 XT 15-17	0213-0785	0213-0785	-	-
PROWLER 1000 XTX 11-14	0213-0785	0213-0785	-	-
PROWLER 1000 XTX H2 09-11	0213-0785	0213-0785	-	-
WILDCAT 1000 14-15	0213-0785	0213-0785	-	-
WILDCAT 4 13-14	0213-0785	0213-0785	-	-
WILDCAT 4 LTD 14	0213-0785	0213-0785	-	-
WILDCAT 4X 14-15	0213-0785	0213-0785	-	-
WILDCAT GT 12-13	0213-0785	0213-0785	-	-
WILDCAT LTD 13-14	0213-0785	0213-0785	-	-
WILDCAT X 13	0213-0785	0213-0785	-	-
CAN-AM				
OUTLANDER 330 04-05	0213-0763	0213-0763	-	-
OUTLANDER 400 03-04	0213-0763	0213-0763	-	-
OUTLANDER 400 STD 2X4 05	0213-0763	0213-0763	-	-
OUTLANDER 400 STD 4X4 05-07	0213-0763	0213-0763	-	-
OUTLANDER 400 STD 4X4 08	0213-0763	0213-0764	-	-
OUTLANDER 400 STD 4X4 09-15	0213-0763	0213-0763	-	-
OUTLANDER 400 XT 4X4 04-05	0213-0763	0213-0763	-	-
OUTLANDER 400 XT 4X4 06	0213-0763	0213-0764	-	-
OUTLANDER 400 XT 4X4 07	0213-0763	0213-0763	-	-
OUTLANDER 400 XT 4X4 08	0213-0763	-	-	-
OUTLANDER 400 XT 4X4 12-14	0213-0763	0213-0764	-	-
OUTLANDER MAX 400 EFI/STD/XT 15	0213-0763	0213-0763	-	-
OUTLANDER MAX 400 STD 4X4 05-07	0213-0763	0213-0763	-	-
OUTLANDER MAX 400 STD 4X4 08	0213-0764	0213-0764	-	-
OUTLANDER MAX 400 STD 4X4 09-11	0213-0764	0213-0763	-	-
OUTLANDER MAX 400 STD 4X4 13-14	0213-0763	0213-0763	-	-
OUTLANDER MAX 400 XT 4X4 06	0213-0763	0213-0763	-	-
OUTLANDER MAX 400 XT 4X4 07	0213-0763	0213-0764	-	-
OUTLANDER MAX 400 XT 4X4 08	0213-0764	0213-0764	-	-

FITS MODEL	WHEEL STUD & NUT KIT FRONT #	WHEEL STUD & NUT KIT REAR #	WHEEL STUD & NUT KIT LEFT REAR #	WHEEL STUD & NUT KIT RIGHT REAR #
WHEEL STUD AND NUT KITS (CON'T)				
CAN-AM (CON'T)				
OUTLANDER MAX 400 XT 4X4 13-14	0213-0763	0213-0764	-	-
OUTLANDER L 450 EFI 15	0213-0765	0213-0765	-	-
OUTLANDER L 450 EFI 16	0213-0766	-	-	-
OUTLANDER L MAX 450 EFI 15	0213-0765	-	-	-
OUTLANDER L MAX 450 EFI 16	0213-0766	-	-	-
OUTLANDER MAX 450 EFI 17	0213-0765	0213-0765	-	-
OUTLANDER MAX STD 450 EFI 18	0213-0765	0213-0765	-	-
OUTLANDER STD 450 EFI 17-18	0213-0765	0213-0765	-	-
OUTLANDER 500 LTD 4X4 10	0213-0764	0213-0764	-	-
OUTLANDER 500 STD 4X4 07-08	0213-0763	0213-0763	-	-
OUTLANDER 500 STD 4X4 09	0213-0764	0213-0763	-	-
OUTLANDER 500 STD 4X4 10-12	0213-0764	0213-0764	-	-
OUTLANDER 500 STD 4X4 13	0213-0765	0213-0765	-	-
OUTLANDER 500 STD 4X4 14-15	0213-0766	-	-	-
OUTLANDER 500 XT 4X4 07-09	0213-0764	0213-0764	-	-
OUTLANDER 500 XT 4X4 10	0213-0767	0213-0764	-	-
OUTLANDER 500 XT 4X4 11	0213-0764	0213-0764	-	-
OUTLANDER 500 XT 4X4 12	0213-0767	0213-0764	-	-
OUTLANDER 500 XT 4X4 13	0213-0766	0213-0766	-	-
OUTLANDER 500 XT 4X4 14	0213-0766	-	-	-
OUTLANDER L 500 EFI 15	0213-0765	0213-0765	-	-
OUTLANDER L MAX 500 EFI 15	0213-0765	0213-0765	-	-
OUTLANDER MAX 500 STD 4X4 07-09	0213-0763	0213-0763	-	-
OUTLANDER MAX 500 STD 4X4 10-12	0213-0764	0213-0764	-	-
OUTLANDER MAX 500 STD 4X4 13	0213-0765	0213-0766	-	-
OUTLANDER MAX 500 XT 4X4 07-08	0213-0763	0213-0764	-	-
OUTLANDER MAX 500 XT 4X4 09	0213-0764	0213-0763	-	-
OUTLANDER MAX 500 XT 4X4 10	0213-0767	0213-0764	-	-
OUTLANDER MAX 500 XT 4X4 11-12	0213-0764	0213-0764	-	-
OUTLANDER MAX 500 XT 4X4 13-14	0213-0766	0213-0766	-	-
RENEGADE 500 08-12	0213-0764	0213-0764	-	-
RENEGADE 500 13-15	0213-0766	0213-0766	-	-
TRAXTER 500 02-03	0213-0763	-	-	-
TRAXTER 500 04-05	0213-0763	0213-0763	-	-
TRAXTER 500 AUTO CVT 05	0213-0763	0213-0763	-	-
OUTLANDER DPS 570 EFI 16-17	0213-0766	-	-	-
OUTLANDER L 570 EFI 16	0213-0766	0213-0765	-	-
OUTLANDER LE 570 EFI 16	0213-0766	0213-0765	-	-
OUTLANDER MAX 570 EFI 16	0213-0766	0213-0766	-	-
OUTLANDER MAX 570 EFI 17	0213-0765	0213-0765	-	-
OUTLANDER MAX DPS 570 EFI 16	0213-0766	-	-	-
OUTLANDER MAX STD 570 EFI 18	0213-0765	0213-0765	-	-
OUTLANDER STD 570 EFI 17-18	0213-0765	0213-0765	-	-
OUTLANDER XMR 570 EFI 16-18	0213-0766	0213-0766	-	-
OUTLANDER 650 6X6 15	0213-0766	0213-0766	-	-
OUTLANDER 650 STD 4X4 06	0213-0764	0213-0763	-	-
OUTLANDER 650 STD 4X4 07	0213-0763	0213-0763	-	-
OUTLANDER 650 STD 4X4 08	0213-0763	0213-0764	-	-
OUTLANDER 650 STD 4X4 09	0213-0763	0213-0763	-	-
OUTLANDER 650 STD 4X4 10	0213-0764	0213-0764	-	-
OUTLANDER 650 STD 4X4 11	0213-0764	0213-0767	-	-
OUTLANDER 650 STD 4X4 12	0213-0764	0213-0764	-	-
OUTLANDER 650 STD 4X4 13-15	0213-0766	0213-0766	-	-
OUTLANDER 650 XMR 13-14	0213-0766	0213-0766	-	-
OUTLANDER 650 XMR 15	0213-0765	0213-0766	-	-
OUTLANDER 650 XT 4X4 06	0213-0764	0213-0764	-	-
OUTLANDER 650 XT 4X4 07	0213-0763	0213-0763	-	-
OUTLANDER 650 XT 4X4 08-09	0213-0763	0213-0764	-	-
OUTLANDER 650 XT 4X4 10	0213-0764	0213-0764	-	-
OUTLANDER 650 XT 4X4 11	0213-0764	0213-0767	-	-
OUTLANDER 650 XT 4X4 12	0213-0767	0213-0767	-	-
OUTLANDER 650 XT 4X4 13	0213-0765	0213-0765	-	-
OUTLANDER 650 XT 4X4 14	0213-0766	-	-	-
OUTLANDER DPS 650 EFI 17	0213-0766	0213-0766	-	-
OUTLANDER MAX 650 STD 4X4 06-09	0213-0763	0213-0763	-	-
OUTLANDER MAX 650 STD 4X4 11-12	0213-0764	0213-0764	-	-
OUTLANDER MAX 650 STD 4X4 13	0213-0766	0213-0765	-	-
OUTLANDER MAX 650 STD 4X4 15	-	0213-0766	-	-
OUTLANDER MAX 650 XT 4X4 06	0213-0763	0213-0763	-	-
OUTLANDER MAX 650 XT 4X4 07-09	0213-0764	0213-0764	-	-
OUTLANDER MAX 650 XT 4X4 11-12	0213-0767	0213-0767	-	-
OUTLANDER MAX 650 XT 4X4 13-14	0213-0766	0213-0766	-	-
OUTLANDER STD 650 EFI 17	0213-0765	0213-0765	-	-
TRAXTER 650 AUTO CVT 05	0213-0763	0213-0763	-	-

FITS MODEL	WHEEL STUD & NUT KIT FRONT #	WHEEL STUD & NUT KIT REAR #	WHEEL STUD & NUT KIT LEFT REAR #	WHEEL STUD & NUT KIT RIGHT REAR #
WHEEL STUD AND NUT KITS (CON'T)				
CAN-AM (CON'T)				
COMMANDER 800 DPS 13-15	0213-0774	-	0213-0764	0213-0774
COMMANDER 800 DPS 16	-	-	0213-0764	0213-0774
COMMANDER 800 LTD 16	-	-	0213-0764	0213-0774
COMMANDER 800 STD 11-16	0213-0768	-	0213-0763	0213-0768
COMMANDER 800 XT 11-15	0213-0774	-	0213-0764	0213-0774
COMMANDER 800 XT 16	-	-	0213-0767	-
COMMANDER 800 XT 17	-	-	-	-
COMMANDER 800 XTP 16	0213-0769	0213-0769	-	-
DEFENDER 800 16-17	0213-0763	0213-0763	-	-
DEFENDER 800 XT/DPS 16	0213-0767	0213-0767	-	-
DEFENDER 800 XT/DPS 17	0213-0763	0213-0767	-	-
OUTLANDER 800 STD 4X4 06-08	0213-0763	0213-0763	-	-
OUTLANDER 800 XMR 11-12	0213-0767	0213-0767	-	-
OUTLANDER 800 XT 4X4 06	0213-0763	0213-0763	-	-
OUTLANDER 800 XT 4X4 07-08	0213-0763	0213-0764	-	-
OUTLANDER 800 XXC 11	0213-0767	0213-0767	-	-
OUTLANDER 800R EFI XMR 15	0213-0766	0213-0766	-	-
OUTLANDER 800R STD 4X4 09	0213-0763	0213-0763	-	-
OUTLANDER 800R STD 4X4 10-11	0213-0767	0213-0764	-	-
OUTLANDER 800R STD 4X4 12-13	0213-0766	0213-0765	-	-
OUTLANDER 800R STD 4X4 14-15	0213-0766	0213-0766	-	-
OUTLANDER 800R XT 4X4 09	0213-0764	0213-0764	-	-
OUTLANDER 800R XT 4X4 10-11	0213-0767	0213-0764	-	-
OUTLANDER 800R XT 4X4 12-13	0213-0766	0213-0766	-	-
OUTLANDER 800R XT 4X4 14	0213-0766	-	-	-
OUTLANDER MAX 800 LTD 4X4 07-08	0213-0764	0213-0764	-	-
OUTLANDER MAX 800 STD 4X4 06-08	0213-0763	0213-0763	-	-
OUTLANDER MAX 800 XT 4X4 06	0213-0763	0213-0763	-	-
OUTLANDER MAX 800 XT 4X4 07-08	0213-0764	0213-0764	-	-
OUTLANDER MAX 800R EFI 15	0213-0766	0213-0766	-	-
OUTLANDER MAX 800R LTD 4X4 09	0213-0763	0213-0764	-	-
OUTLANDER MAX 800R LTD 4X4 10-11	0213-0764	0213-0764	-	-
OUTLANDER MAX 800R LTD 4X4 12	0213-0767	0213-0764	-	-
OUTLANDER MAX 800R STD 4X4 09	0213-0764	0213-0763	-	-
OUTLANDER MAX 800R STD 4X4 10	0213-0767	0213-0767	-	-
OUTLANDER MAX 800R STD 4X4 11	0213-0764	0213-0767	-	-
OUTLANDER MAX 800R STD 4X4 12	0213-0767	0213-0765	-	-
OUTLANDER MAX 800R STD 4X4 13	0213-0766	0213-0765	-	-
OUTLANDER MAX 800R STD 4X4 14	0213-0766	0213-0766	-	-
OUTLANDER MAX 800R XT 4X4 09	0213-0767	0213-0763	-	-
OUTLANDER MAX 800R XT 4X4 10	0213-0764	0213-0764	-	-
OUTLANDER MAX 800R XT 4X4 11	0213-0767	0213-0764	-	-
OUTLANDER MAX 800R XT 4X4 12	0213-0767	0213-0766	-	-
OUTLANDER MAX 800R XT 4X4 13-14	0213-0766	0213-0766	-	-
OUTLANDER 850 16	0213-0765	0213-0765	-	-
OUTLANDER 850 XMR 16	0213-0766	0213-0766	-	-
OUTLANDER 850 XT 16	0213-0766	0213-0766	-	-
OUTLANDER DPS 850 EFI 17	0213-0766	0213-0766	-	-
OUTLANDER MAX DPS 850 EFI 17	0213-0766	0213-0766	-	-
COMMANDER 1000 DPS 16	0213-0774	-	0213-0764	0213-0774
COMMANDER 1000 LTD 16	0213-0774	-	0213-0764	0213-0774
COMMANDER 1000 STD 11-14	0213-0768	-	0213-0763	0213-0768
COMMANDER 1000 STD 15	-	-	0213-0764	0213-0774
COMMANDER 1000 STD 16	0213-0774	-	0213-0763	0213-0768
COMMANDER 1000 XT 16	0213-0774	-	0213-0767	-
COMMANDER 1000 XT/LTD/DPS 11-15	0213-0774	-	0213-0764	0213-0774
COMMANDER 1000 XTP 14	-	-	0213-0767	-
COMMANDER 1000 XTP 15	0213-0769	-	0213-0767	-
COMMANDER 1000 XTP 16-17	0213-0769	0213-0769	-	-
COMMANDER MAX 1000 STD 15	0213-0769	0213-0769	-	-
COMMANDER MAX 1000 STD 16	0213-0769	-	-	-
COMMANDER MAX 1000	-	-	-	-
XT/DPS/LTD 14-16	0213-0769	0213-0769	-	-
COMMANDER MAX 1000 XTP 15	0213-0769	0213-0769	-	-
DEFENDER 1000 16-17	0213-0763	0213-0763	-	-
DEFENDER 1000 XT/DPS 16	0213-0767	0213-0767	-	-
DEFENDER 1000 XT/DPS 17	0213-0763	0213-0767	-	-
DEFENDER MAX 1000 XT/DPS 17	0213-0767	0213-0767	-	-
MAVERICK 1000 STD 13-16	0213-0769	0213-0769	-	-
MAVERICK 1000 TURBO 17	0213-0769	0213-0769	-	-
MAVERICK 1000 XC/XXC/DPS 17	0213-0769	0213-0769	-	-
MAVERICK 1000 XDS-DPS 15	0213-0769	0213-0769	-	-
MAVERICK 1000 XMR 14-17	0213-0769	0213-0769	-	-
MAVERICK 1000 XRS-DPS 14-15	0213-0769	0213-0769	-	-

PLOWES
WINCHES
UTV
RACKS
IMPLEMENTATION & TOWING
LUGGAGE
BODY
CONTROLS
ELECTRICAL
WHEELS & TIRES
SUSPENSION & DRIVE
BRAKING
ENGINE
RIDER
GARAGE
PROMO

WHEELS & TIRES

FITS MODEL	WHEEL STUD & NUT KIT FRONT #	WHEEL STUD & NUT KIT REAR #	WHEEL STUD & NUT KIT LEFT REAR #	WHEEL STUD & NUT KIT RIGHT REAR #
WHEEL STUD AND NUT KITS (CON'T)				
CAN-AM (CON'T)				
MAVERICK 1000 XC 14-15	0213-0769	0213-0769	-	-
MAVERICK MAX 1000 DPS 17	0213-0769	0213-0769	-	-
MAVERICK MAX 1000 STD 14-16	0213-0769	0213-0769	-	-
MAVERICK MAX 1000 TURBO 17	0213-0769	0213-0769	-	-
MAVERICK MAX 1000 XC/XXC 16	0213-0769	0213-0769	-	-
MAVERICK MAX 1000 XDS-DPS 14-15	0213-0769	0213-0769	-	-
MAVERICK MAX 1000 XMR 17	0213-0769	0213-0769	-	-
MAVERICK MAX 1000 XRS-DPS 14-15	0213-0769	0213-0769	-	-
OUTLANDER 1000 EFI 6X6 15	0213-0766	0213-0766	-	-
OUTLANDER 1000 STD 4X4 12-14	0213-0766	0213-0766	-	-
OUTLANDER 1000 STD 4X4 15	0213-0766	-	-	-
OUTLANDER 1000 XMR 13-15	0213-0766	0213-0766	-	-
OUTLANDER 1000 XT 4X4 12-14	0213-0766	0213-0766	-	-
OUTLANDER DPS 1000 EFI 17	0213-0766	0213-0766	-	-
OUTLANDER MAX 1000 EFI 15	0213-0766	-	-	-
OUTLANDER MAX 1000 EFI LTD 15	0213-0766	-	-	-
OUTLANDER MAX 1000 STD 4X4 13-14	0213-0766	0213-0766	-	-
OUTLANDER MAX 1000 XT 4X4 13-14	0213-0766	0213-0766	-	-
OUTLANDER XMR DPS 1000 EFI 17	0213-0766	0213-0766	-	-
HONDA				
TRX200 90-91	0213-0759	0213-0756	-	-
TRX200D 90-97	0213-0759	0213-0756	-	-
TRX200SX 86-88	0213-0759	0213-0756	-	-
ATC250R 85-86	0213-0755	0213-0755	-	-
TRX250 RECON 97-01	0213-0759	0213-0756	-	-
TRX250R 86-89	0213-0755	0213-0755	-	-
TRX250TE RECON 02-18	0213-0759	0213-0756	-	-
TRX250TM RECON 02-08	0213-0759	0213-0756	-	-
TRX250TM RECON 09-11	0213-0759	0213-0759	-	-
TRX250TM RECON 12-18	0213-0759	0213-0756	-	-
TRX300 FOURTRAX 88-00	0213-0759	0213-0756	-	-
TRX300FW FOURTRAX 4X4 88-00	-	0213-0756	-	-
ATC350X 85-86	-	0213-0755	-	-
TRX350FE 00-06	0213-0760	0213-0756	-	-
TRX350FM FOURTRAX RANCHER 00-06	0213-0760	0213-0756	-	-
TRX350TE 00-06	0213-0759	0213-0756	-	-
TRX350TM FOURTRAX RANCHER 00	0213-0760	0213-0756	-	-
TRX350TM FOURTRAX RANCHER 01-05	0213-0759	0213-0756	-	-
TRX350TM FOURTRAX RANCHER 06	0213-0759	0213-0756	-	-
TRX400FA 04-07	0213-0760	0213-0756	-	-
TRX400FGA FOURTRAX RANCHER 4X4 04-07	0213-0760	0213-0756	-	-
TRX400FW FOURTRAX FOREMAN 4X4 95-01	-	0213-0756	-	-
TRX400FW FOURTRAX FOREMAN 4X4 02-03	0213-0760	0213-0756	-	-
TRX420 FA IRS 09-14	0213-0756	0213-0756	-	-
TRX420 FA IRS 15	0213-0759	0213-0756	-	-
TRX420 FA IRS 16-18	0213-0759	0213-0756	-	-
TRX420 FA SOLID AXLE 14-18	0213-0759	0213-0756	-	-
TRX420 FE 07-13	0213-0756	0213-0756	-	-
TRX420 FE 14-18	0213-0759	0213-0756	-	-
TRX420 FM 07-13	0213-0756	0213-0756	-	-
TRX420 FM 14-18	0213-0759	0213-0756	-	-
TRX420 FPA IRS 09-14	0213-0756	0213-0756	-	-
TRX420 FPA SOLID AXLE 14	0213-0759	0213-0756	-	-
TRX420 FPE 11-13	0213-0756	0213-0756	-	-
TRX420 FPM 11-13	0213-0756	0213-0756	-	-
TRX420 TE 07-16	0213-0759	0213-0756	-	-
TRX420 TM 07-18	0213-0759	0213-0756	-	-
TRX450ER 06-14	0213-0755	0213-0755	-	-
TRX450ES 98-01	-	0213-0756	-	-
TRX450S 98-01	-	0213-0756	-	-
TRX500FA 01-04	0213-0758	0213-0761	-	-
TRX500FA 05-06	0213-0757	0213-0761	-	-
TRX500FA 07	0213-0759	-	-	-
TRX500FA 08-11	0213-0759	-	-	-
TRX500FA 12-14	0213-0756	0213-0756	-	-
TRX500FA 15-17	0213-0759	0213-0756	-	-
TRX500FA 18	0213-0759	0213-0756	-	-
TRX500FE 05-13	0213-0756	0213-0756	-	-
TRX500FE 14-18	0213-0759	0213-0756	-	-
TRX500FGA 04	0213-0758	0213-0761	-	-
TRX500FGA 05-06	0213-0757	0213-0761	-	-

FITS MODEL	WHEEL STUD & NUT KIT FRONT #	WHEEL STUD & NUT KIT REAR #	WHEEL STUD & NUT KIT LEFT REAR #	WHEEL STUD & NUT KIT RIGHT REAR #
WHEEL STUD AND NUT KITS (CON'T)				
HONDA (CON'T)				
TRX500FGA 07-08	0213-0759	-	-	-
TRX500FM 05-13	0213-0756	0213-0756	-	-
TRX500FM IRS 15-18	0213-0759	0213-0756	-	-
TRX500FM SOLID AXLE 14-18	0213-0759	0213-0756	-	-
TRX500FPA 09-11	0213-0759	-	-	-
TRX500FPA 12-14	0213-0756	0213-0756	-	-
TRX500FPE 07-13	0213-0756	0213-0756	-	-
TRX500FPM 08-13	0213-0756	0213-0756	-	-
TRX500TM 05-06	0213-0759	0213-0756	-	-
TRX650 RINCON 03-05	0213-0758	0213-0757	-	-
TRX680 RINCON 06-16	0213-0757	0213-0757	-	-
TRX680 RINCON 17-18	0213-0756	0213-0756	-	-
KAWASAKI				
KVF360A PRAIRIE 4X4 03-12	0213-0749	0213-0749	-	-
KVF360B PRAIRIE 03-11	0213-0749	0213-0749	-	-
KVF360C PRAIRIE 4X4 03-12	0213-0749	0213-0749	-	-
KFX400 03-06	0213-0750	0213-0752	-	-
MULE 600 08-16	0213-0754	0213-0754	-	-
MULE 610 4X4 08-16	0213-0754	0213-0754	-	-
MULE SX 17-18	0213-0754	0213-0754	-	-
KFX450R 08-14	0213-0749	0213-0749	-	-
MULE 3000 08	0213-0753	0213-0753	-	-
MULE 3010 4X4 08	0213-0753	0213-0753	-	-
MULE 4000 09-18	0213-0753	0213-0753	-	-
MULE 4010 4X4 09-18	0213-0753	0213-0753	-	-
KVF650 BRUTE FORCE 05-13	0213-0749	-	-	-
KVF650 BRUTE FORCE 06-07	0213-0751	0213-0751	-	-
KVF650 BRUTE FORCE 08	0213-0751	-	-	-
KVF650 BRUTE FORCE 09-13	0213-0751	0213-0751	-	-
KVF650 PRAIRIE 02-03	0213-0749	-	-	-
KFX 700 V-FORCE 04-09	0213-0749	0213-0749	-	-
KVF700 PRAIRIE 04-06	0213-0749	-	-	-
KVF750 BRUTE FORCE 05-07	0213-0751	0213-0751	-	-
KVF750 BRUTE FORCE 08-10	0213-0749	-	-	-
KVF750 BRUTE FORCE 11	0213-0748	-	-	-
KVF750 BRUTE FORCE 12-18	0213-0748	0213-0748	-	-
KVF750 BRUTE FORCE EPS 12-18	0213-0748	0213-0748	-	-
TERYX 4 4X4 12-13	0213-0753	0213-0753	-	-
TERYX 750 4X4 08-13	0213-0753	0213-0753	-	-
MULE PRO-FX 800 15-18	0213-0753	0213-0753	-	-
MULE PRO-FXT 800 15-18	0213-0753	0213-0753	-	-
TERYX 4 4X4 800 14-18	0213-0753	0213-0753	-	-
TERYX 4X4 800 14-18	0213-0753	0213-0753	-	-
MULE 3010 DIESEL 07-08	0213-0753	0213-0753	-	-
MULE 4010 4X4 DIESEL 09-13	0213-0753	0213-0753	-	-
MULE PRO-DX & DXT 16-18	0213-0753	0213-0753	-	-
POLARIS				
LSV ELECTRIC 4X4 11-12	0213-0778	0213-0778	-	-
RANGER EV 4X4 10	-	0213-0778	-	-
RANGER EV 4X4 11-15	0213-0778	0213-0778	-	-
RANGER EV 4X4 16-17	0213-0778	-	-	-
BIG BOSS 250 6X6 93	0213-0771	-	-	-
TRAIL BLAZER 250 93-04	0213-0771	-	-	-
TRAIL BLAZER 250 05-06	0213-0772	-	-	-
TRAIL BOSS 250 2X4 93-99	0213-0771	-	-	-
TRAIL BOSS 250 4X4 93-95	0213-0771	-	-	-
XPLORER 250 4X4 00-02	0213-0771	-	-	-
300 2X4 & 4X4 94-95	0213-0771	-	-	-
BIG BOSS 300 6X6 94	0213-0771	-	-	-
HAWKEYE 2X4 06	0213-0772	0213-0772	-	-
HAWKEYE 2X4 08-11	-	0213-0772	-	-
HAWKEYE 4X4 06	-	0213-0772	-	-
SPORTSMAN 300 4X4 09-10	-	0213-0772	-	-
XPLORER 300 4X4 96-99	0213-0771	-	-	-
XPRESS 300 96-99	0213-0771	-	-	-
ACE 325 14-16	0213-0773	0213-0773	-	-
ACE 325 HD 15	0213-0773	0213-0773	-	-
HAWKEYE 325 2X4 15	0213-0773	0213-0773	-	-
MAGNUM 325 2X4 00-01	0213-0771	-	-	-
MAGNUM 325 2X4 02	0213-0771	0213-0772	-	-
MAGNUM 325 4X4 00-01	0213-0771	-	-	-
MAGNUM 325 4X4 02	0213-0771	0213-0772	-	-
MAGNUM 325 4X4 HDS 02	0213-0771	0213-0772	-	-
MAGNUM 325 4X4 HDS AA 01	0213-0771	-	-	-

FITS MODEL	WHEEL STUD & NUT KIT FRONT #	WHEEL STUD & NUT KIT REAR #	WHEEL STUD & NUT KIT LEFT REAR #	WHEEL STUD & NUT KIT RIGHT REAR #
WHEEL STUD AND NUT KITS (CON'T)				
POLARIS (CON'T)				
MAGNUM 325 4X4 HDS FB 01	0213-0771	-	-	-
RANGER 325 ETX 15-16	0213-0778	0213-0778	-	-
SPORTSMAN 325 ETX EFI 15	0213-0773	0213-0773	-	-
TRAIL BOSS 325 00-02	0213-0771	-	-	-
XPEDITION 325 00-01	0213-0771	-	-	-
XPEDITION 325 02	0213-0771	0213-0772	-	-
ATP 330 4X4 04-05	0213-0772	0213-0772	-	-
MAGNUM 330 2X4 03	0213-0771	0213-0772	-	-
MAGNUM 330 2X4 04-05	0213-0772	0213-0772	-	-
MAGNUM 330 4X4 05	0213-0772	0213-0772	-	-
MAGNUM 330 4X4 AA AB AC 03-04	0213-0772	0213-0772	-	-
MAGNUM 330 4X4 FB 03-04	0213-0772	0213-0772	-	-
TRAIL BLAZER 330 08-09	0213-0772	-	-	-
TRAIL BLAZER 330 10-13	0213-0773	-	-	-
TRAIL BOSS 330 03-09	0213-0772	-	-	-
TRAIL BOSS 330 10-13	0213-0773	-	-	-
SPORTSMAN 335 99-00	-	0213-0772	-	-
WORKER 335 99	-	0213-0772	-	-
350L 2X4 & 4X4 93	0213-0771	-	-	-
BIG BOSS 350L 6X6 93	0213-0771	-	-	-
SPORTSMAN 350 4X4 93	0213-0771	-	-	-
400L 2X4 94-95	0213-0771	-	-	-
400L 4X4 94	0213-0771	-	-	-
BIG BOSS 400L 6X6 94-97	0213-0771	-	-	-
HAWKEYE 400 HO 2X4 11-14	0213-0773	0213-0773	-	-
MAGNUM 400L 6X6 96-97	0213-0771	-	-	-
RANGER 4X4 400 10-14	0213-0778	0213-0778	-	-
SPORTSMAN 400 4X4 94-97	0213-0771	-	-	-
SPORTSMAN 400 4X4 02-03	0213-0771	0213-0772	-	-
SPORTSMAN 400 4X4 05	0213-0772	0213-0772	-	-
SPORTSMAN 400 4X4 AA AE AG 04	0213-0772	0213-0772	-	-
SPORTSMAN 400 4X4 AQ-AV 04	0213-0772	0213-0772	-	-
SPORTSMAN 400 4X4 BUILT AFTER 12/7/00 01	0213-0771	0213-0772	-	-
SPORTSMAN 400 4X4 BUILT BEFORE 12/7/00 01	0213-0771	0213-0772	-	-
SPORTSMAN 400 HO 4X4 09-10	0213-0772	0213-0772	-	-
SPORTSMAN 400 HO 4X4 11-14	0213-0773	0213-0773	-	-
SPORTSMAN 400 HO 4X4 BUILT AFTER 9/16 08	0213-0772	0213-0772	-	-
SPORTSMAN 400 HO 4X4 BUILT BEFORE 9/16 08	0213-0772	0213-0772	-	-
TRAIL BLAZER 400 03	0213-0771	-	-	-
XPLORER 400L 4X4 95-02	0213-0771	-	-	-
XPRESS 400L 2X4 96-97	0213-0771	-	-	-
MAGNUM 425 2X4 95-97	0213-0771	-	-	-
MAGNUM 425 2X4 98	0213-0771	-	-	-
MAGNUM 425 4X4 95-98	0213-0771	-	-	-
XPEDITION 425 00	0213-0771	-	-	-
XPEDITION 425 01-02	0213-0771	-	-	-
OUTLAW 450 08-10	0213-0772	0213-0772	-	-
SPORTSMAN 450 06	0213-0772	0213-0772	-	-
SPORTSMAN 450 BUILT AFTER 7/25/06 07	0213-0772	0213-0772	-	-
SPORTSMAN 450 BUILT BEFORE 7/25/06 07	0213-0772	0213-0772	-	-
SPORTSMAN 450 HO 16-17	0213-0773	0213-0773	-	-
DIESEL 455 4X4 00-01	0213-0771	0213-0772	-	-
DIESEL 455 4X4 BUILT AFTER 9/98 99	-	0213-0772	-	-
DIESEL 455 4X4 BUILT BEFORE 9/98 99	-	0213-0772	-	-
ACE 500 17	0213-0773	0213-0773	-	-
ATP 500 4X4 04-05	0213-0772	0213-0772	-	-
BIG BOSS 500 6X6 98-99	0213-0771	-	-	-
BIG BOSS 500 6X6 00	0213-0771	-	-	-
BIG BOSS 500 6X6 01-02	0213-0771	-	-	-
MAGNUM 500 4X4 01	0213-0771	-	-	-
MAGNUM 500 4X4 AA 02	0213-0771	-	-	-
MAGNUM 500 4X4 AB/FB 02	0213-0771	0213-0772	-	-
MAGNUM 500 4X4 BUILT AFTER 9/1/98 99	0213-0771	-	-	-
MAGNUM 500 4X4 BUILT BEFORE 9/1/98 99	0213-0771	-	-	-
MAGNUM 500 4X4 HDS 03	0213-0772	0213-0772	-	-

FITS MODEL	WHEEL STUD & NUT KIT FRONT #	WHEEL STUD & NUT KIT REAR #	WHEEL STUD & NUT KIT LEFT REAR #	WHEEL STUD & NUT KIT RIGHT REAR #
WHEEL STUD AND NUT KITS (CON'T)				
POLARIS (CON'T)				
MAGNUM 500 4X4 HDS AA & FB 01	0213-0771	-	-	-
OUTLAW 500 06-07	0213-0772	0213-0772	-	-
PREDATOR 500 03-07	0213-0772	0213-0772	-	-
PTV SERIES 10 6X6 03	0213-0771	-	-	-
RANGER 2X4 500 09	0213-0778	0213-0778	-	-
RANGER 4X4 500 99	0213-0771	0213-0772	-	-
RANGER 4X4 500 04	0213-0772	0213-0772	-	-
RANGER 4X4 500 CREW 11	0213-0778	0213-0778	-	-
RANGER 4X4 500 EFI 09-10	0213-0779	0213-0778	-	-
RANGER 4X4 500 EFI 11	0213-0778	0213-0778	-	-
RANGER 6X6 500 99	0213-0771	0213-0772	-	-
RANGER 6X6 500 04	0213-0772	0213-0772	-	-
RANGER SERIES 10 4X4 & 6X6 07	0213-0771	0213-0772	-	-
RANGER SERIES 11 4X4 & 6X6 07	-	0213-0772	-	-
SCRAMBLER 500 2X4 00-02	0213-0771	-	-	-
SCRAMBLER 500 2X4 08	0213-0772	-	-	-
SCRAMBLER 500 4X4 97-04	0213-0771	-	-	-
SCRAMBLER 500 4X4 05-09	0213-0772	-	-	-
SCRAMBLER 500 4X4 10-12	0213-0773	-	-	-
SPORTSMAN 500 4X4 96-00	0213-0771	0213-0772	-	-
SPORTSMAN 500 4X4 BUILT AFTER 9/98 99	0213-0771	0213-0772	-	-
SPORTSMAN 500 4X4 BUILT BEFORE 9/98 99	0213-0771	0213-0772	-	-
SPORTSMAN 500 4X4 DUSE 01-02	0213-0771	0213-0772	-	-
SPORTSMAN 500 4X4 DUSE HO 01	0213-0771	0213-0772	-	-
SPORTSMAN 500 4X4 HO 01-13	0213-0773	0213-0773	-	-
SPORTSMAN 500 4X4 HO AA- AC- AE- AG 04	0213-0772	0213-0772	-	-
SPORTSMAN 500 4X4 HO AO-AX 04	0213-0772	0213-0772	-	-
SPORTSMAN 500 4X4 RSE 00-02	0213-0771	0213-0772	-	-
SPORTSMAN 500 4X4 RSE BUILT AFTER 9/98 99	0213-0771	0213-0772	-	-
SPORTSMAN 500 4X4 RSE BUILT BEFORE 9/98 99	0213-0771	0213-0772	-	-
SPORTSMAN 500 6X6 00	0213-0771	-	-	-
SPORTSMAN 500 6X6 01-02	0213-0771	-	-	-
SPORTSMAN 500 6X6 03-08	0213-0772	-	-	-
SPORTSMAN 500 EFI 09	0213-0773	0213-0773	-	-
SPORTSMAN 500 TRACTOR EFI BUILT AFTER 6/23/09 10	0213-0775	0213-0775	-	-
SPORTSMAN 500 TRACTOR EFI BUILT BEFORE 6/23/09 10	0213-0775	0213-0775	-	-
SPORTSMAN 500 X2 06-08	0213-0772	0213-0772	-	-
SPORTSMAN FOREST 500 11-13	0213-0773	0213-0773	-	-
SPORTSMAN FOREST 500 TRACTOR 11	0213-0775	0213-0775	-	-
SPORTSMAN FOREST 500 TRACTOR 12	0213-0775	-	-	-
SPORTSMAN TOURING 500 08-13	0213-0773	0213-0773	-	-
WORKER 500 4X4 00-01	0213-0771	0213-0772	-	-
WORKER 500 4X4 BUILT AFTER 9/98 99	0213-0771	0213-0772	-	-
WORKER 500 4X4 BUILT BEFORE 9/98 99	0213-0771	0213-0772	-	-
XPLORER 500 97	0213-0771	0213-0772	-	-
OUTLAW 525 IRS 07-11	0213-0772	0213-0772	-	-
OUTLAW 525 S 08-10	0213-0772	0213-0772	-	-
SPORTSMAN 550 11-13	0213-0770	0213-0770	-	-
SPORTSMAN 550 X2 10-14	0213-0770	0213-0770	-	-
SPORTSMAN 550 XP 13	0213-0770	0213-0770	-	-
SPORTSMAN 550 XP 14	0213-0776	0213-0776	-	-
SPORTSMAN FOREST 550 11-14	0213-0776	0213-0776	-	-
SPORTSMAN TOURING 550 EPS 10-14	0213-0776	0213-0776	-	-
ACE 570 15	-	0213-0773	-	-
ACE 570 17	0213-0773	0213-0773	-	-
RANGER 570 FULL SIZE 16	-	0213-0777	-	-
RANGER 570 FULL SIZE CREW 17	0213-0778	0213-0778	-	-
RZR 570 EFI 12-13	0213-0786	0213-0773	-	-
RZR 570 EFI 14-15	0213-0779	0213-0773	-	-
SPORTSMAN 570 EFI 14-17	0213-0773	0213-0773	-	-
SPORTSMAN 570 EFI EPS 14-15	0213-0773	0213-0773	-	-
SPORTSMAN 570 EFI EPS FOREST QUAD 15	0213-0773	0213-0773	-	-
SPORTSMAN 570 EFI HD 16-17	0213-0773	0213-0773	-	-
SPORTSMAN 570 EFI UTE 17	0213-0773	0213-0773	-	-

PLOWS
WINCHES
UTV
RACKS
IMPLEMENT & TOWING
LUGGAGE
BODY
CONTROLS
ELECTRICAL
WHEELS & TIRES
SUSPENSION & DRIVE
BRAKING
ENGINE
RIDER
GARAGE
PROMO

WHEELS & TIRES

FITS MODEL	WHEEL STUD & NUT KIT FRONT #	WHEEL STUD & NUT KIT REAR #	WHEEL STUD & NUT KIT LEFT REAR #	WHEEL STUD & NUT KIT RIGHT REAR #
WHEEL STUD AND NUT KITS (CON'T)				
POLARIS (CON'T)				
SPORTSMAN 570 EFI UTE HD 15-16	0213-0773	0213-0773	-	-
SPORTSMAN 570 EFI X2 16-17	0213-0773	0213-0773	-	-
SPORTSMAN 570 EFI X2 EPS 15	0213-0773	0213-0773	-	-
SPORTSMAN 570 HD 15	0213-0773	0213-0773	-	-
SPORTSMAN 570 HD EFI 14	0213-0773	0213-0773	-	-
SPORTSMAN 570 SP 15-17	0213-0775	0213-0775	-	-
SPORTSMAN 570 SP EPS TRACTOR 15	0213-0775	0213-0775	-	-
SPORTSMAN FOREST 570 14	0213-0773	0213-0773	-	-
SPORTSMAN FOREST 570 EFI EPS 14-15	0213-0773	0213-0773	-	-
SPORTSMAN TOURING 570 EFI 14-17	0213-0773	0213-0773	-	-
SPORTSMAN TOURING 570 EFI EPS 15	0213-0773	0213-0773	-	-
SPORTSMAN TOURING 570 SP 15-17	0213-0775	0213-0775	-	-
SPORTSMAN 600 4X4 03-05	0213-0772	0213-0772	-	-
SPORTSMAN 600 4X4 BUILT AFTER 10/02/03 04	0213-0772	0213-0772	-	-
SPORTSMAN 600 4X4 BUILT BEFORE 10/02/03 04	0213-0772	0213-0772	-	-
RANGER 6X6 700 EFI 06-09	0213-0778	0213-0778	-	-
RANGER TM 700 04	0213-0772	0213-0772	-	-
SPORTSMAN 700 4X4 02-07	0213-0772	0213-0772	-	-
SPORTSMAN 700 4X4 BUILT AFTER 10/02/03 04	0213-0772	0213-0772	-	-
SPORTSMAN 700 4X4 BUILT BEFORE 10/02/03 04	0213-0772	0213-0772	-	-
SPORTSMAN 700 EFI 05-07	0213-0772	0213-0772	-	-
SPORTSMAN MV7 05	0213-0772	0213-0772	-	-
SPORTSMAN X2 700 EFI 08	0213-0772	0213-0772	-	-
RANGER 4X4 800 EFI CREW 10-12	-	0213-0778	-	-
RANGER 4X4 800 EFI CREW 13	0213-0779	0213-0778	-	-
RANGER 4X4 800 EFI CREW 14	0213-0779	0213-0779	-	-
RANGER 6X6 800 10-16	0213-0779	0213-0778	-	-
RZR 4 800 10-14	0213-0780	0213-0775	-	-
RZR 800 08	0213-0786	0213-0773	-	-
RZR S 800 09-14	0213-0781	0213-0775	-	-
RZR S 800 BUILT AFTER 3/22/10 10	0213-0781	0213-0775	-	-
RZR S 800 BUILT BEFORE 3/21/10 10	0213-0781	0213-0775	-	-
SPORTSMAN 800 EFI 05	-	0213-0775	-	-
SPORTSMAN 800 EFI 07	0213-0775	-	-	-
SPORTSMAN 800 EFI 09-14	0213-0773	0213-0773	-	-
SPORTSMAN 800 EFI 6X6 09-14	0213-0773	0213-0773	-	-
SPORTSMAN 800 EFI 6X6 FOREST 13	0213-0773	0213-0773	-	-
SPORTSMAN 800 EFI FOREST 14	0213-0773	0213-0775	-	-
SPORTSMAN 800 HD EFI 09	0213-0773	0213-0773	-	-
SPORTSMAN FOREST 800 EFI 12-13	0213-0775	0213-0775	-	-
SPORTSMAN TOURING 800 EFI 08-09	0213-0775	0213-0775	-	-
SPORTSMAN X2 800 EFI 07	0213-0775	0213-0772	-	-
SCRAMBLER 850 15-17	0213-0770	0213-0770	-	-
SPORTSMAN 850 HIGH LIFTER 17	0213-0770	0213-0770	-	-
SPORTSMAN 850 SP 15-17	0213-0770	0213-0776	-	-
SPORTSMAN FOREST 850 11-15	0213-0776	0213-0776	-	-
SPORTSMAN TOURING 850 EPS 14	0213-0776	0213-0776	-	-
SPORTSMAN TOURING 850 SP 15-17	0213-0776	0213-0776	-	-
SPORTSMAN TOURING EPS 850 10-13	0213-0776	0213-0776	-	-
SPORTSMAN TOURING EPS 850 HD 13	0213-0776	0213-0776	-	-
SPORTSMAN X2 850 11	0213-0770	0213-0770	-	-
SPORTSMAN XP 850 09-13	0213-0770	0213-0770	-	-
SPORTSMAN XP 850 EPS 09	0213-0770	0213-0770	-	-
SPORTSMAN XP 850 EPS 10	-	0213-0776	-	-
ACE 900 EFI EPS 16	0213-0775	0213-0775	-	-
ACE 900 EFI EPS 17	-	0213-0775	-	-
BRUTUS HD 900 13-15	0213-0777	0213-0777	-	-
RANGER 4X4 900 DIESEL 11-14	0213-0779	0213-0778	-	-
RANGER 4X4 900 DIESEL CREW 12-14	0213-0779	0213-0778	-	-
RANGER 900 CREW 17	0213-0777	0213-0777	-	-
RANGER 900 XP 17	0213-0777	0213-0777	-	-
RANGER DIESEL HST/DELUXE 14	0213-0777	0213-0777	-	-
RZR 4 900 15-17	0213-0782	0213-0782	-	-
RZR 4 XP 900 12-13	0213-0780	0213-0775	-	-
RZR 4 XP JAGGED X 13	0213-0780	0213-0775	-	-
RZR 900 60 INCH 15-17	0213-0782	0213-0782	-	-
RZR XP 900 11-13	0213-0780	0213-0775	-	-
GENERAL 4 1000 EPS 17	0213-0782	0213-0782	-	-
RANGER 1000 DIESEL 15-17	0213-0777	0213-0777	-	-
RANGER 1000 DIESEL CREW 15-17	0213-0777	0213-0777	-	-

FITS MODEL	WHEEL STUD & NUT KIT FRONT #	WHEEL STUD & NUT KIT REAR #	WHEEL STUD & NUT KIT LEFT REAR #	WHEEL STUD & NUT KIT RIGHT REAR #
WHEEL STUD AND NUT KITS (CON'T)				
POLARIS (CON'T)				
RZR 1000 60 INCH 16-17	0213-0782	0213-0782	-	-
RZR XP 1000 14-17	0213-0783	0213-0783	-	-
RZR XP 1000 BUILT AFTER 10/20/15 16	0213-0783	0213-0783	-	-
RZR XP 1000 BUILT BEFORE 10/19/15 16	0213-0783	0213-0783	-	-
RZR XP 4 1000 14-17	0213-0783	0213-0783	-	-
RZR XP 4 1000 BUILT AFTER 10/20/15 16	0213-0783	0213-0783	-	-
RZR XP 4 1000 BUILT BEFORE 10/19/15 16	0213-0783	0213-0783	-	-
RZR XP TURBO 16	0213-0783	0213-0783	-	-
SCRAMBLER 1000 XP 16	0213-0776	0213-0776	-	-
SCRAMBLER 1000 XP HD EPS 14-17	0213-0776	0213-0776	-	-
SPORTSMAN 1000 XP 15-17	0213-0776	0213-0776	-	-
SPORTSMAN TOURING 1000 15-17	0213-0776	0213-0776	-	-
SUZUKI				
LT-F250 OZARK 02-14	0213-0752	0213-0752	-	-
LT-F300F KING QUAD 99-02	0213-0762	-	-	-
LT-A400 2WD KING QUAD 08-09	0213-0762	-	0213-0762	-
LT-A400 EIGER 2WD 02-07	0213-0762	-	0213-0762	-
LT-A400F 4WD KING QUAD 08-17	0213-0762	-	0213-0762	-
LT-A400F EIGER 4WD 02-07	0213-0762	-	0213-0762	-
LT-F400 EIGER 2WD 02-07	0213-0762	-	-	-
LT-F400F 4WD KING QUAD 08-12	0213-0762	-	-	-
LT-F400F 4WD KING QUAD 13-17	0213-0762	-	0213-0762	-
LT-F400F EIGER 4WD 02-07	0213-0762	-	-	-
LTA-450 X KING QUAD 07	0213-0752	0213-0762	-	-
LTA-450 X KING QUAD 08-10	0213-0762	0213-0762	-	-
LT-A500F QUAD MASTER AUTO 00-01	0213-0762	0213-0762	-	-
LT-A500F VINSON 02-07	0213-0762	0213-0762	-	-
LT-A500X 09-15	0213-0752	0213-0752	-	-
LT-A500X 16-17	0213-0762	0213-0762	-	-
LT-A500XP POWER STEERING 11-17	0213-0752	0213-0752	-	-
LT-F500F 98-02	0213-0762	0213-0762	-	-
LT-F500F VINSON 03-07	0213-0762	0213-0762	-	-
LTA-700 X KING QUAD 05-07	0213-0752	0213-0752	-	-
LTA-750 X KING QUAD 08-17	0213-0752	0213-0752	-	-
LTA-750 XP KING QUAD POWER STEERING 11-17	0213-0752	0213-0752	-	-
YAMAHA				
YFA1 89-04	0213-0739	0213-0740	-	-
YFM125 GRIZZLY 04-13	0213-0740	0213-0740	-	-
YFB250 TIMBERWOLF 92-94	0213-0734	-	-	-
YFB250 TIMBERWOLF 98	0213-0743	-	-	-
YFM250 BEARTRACKER 99-04	0213-0741	-	0213-0739	-
YFM250 BIG BEAR 07-09	0213-0740	0213-0740	-	-
YFM250 MOTO-4 89-91	-	0213-0739	-	-
YFM250B BRUIN 05-06	0213-0739	0213-0739	-	-
YFM350 GRIZZLY IRS 07-11	0213-0740	0213-0740	-	-
YFM350 WARRIOR 89-04	0213-0737	0213-0737	-	-
YFM350BA BRUIN 2WD 04-06	0213-0739	0213-0739	-	-
YFM350ER MOTO-4 89-95	-	0213-0739	-	-
YFM350FA BRUIN 4WD 04-06	0213-0739	0213-0739	-	-
YFM350FGW GRIZZLY 4WD 07-14	0213-0740	0213-0740	-	-
YFM350FW BIG BEAR 89-95	-	0213-0739	-	-
YFM350FW BIG BEAR 96-97	-	-	0213-0739	0213-0741
YFM350FW BIG BEAR 98	0213-0741	-	0213-0739	0213-0741
YFM350FW BIG BEAR 99	0213-0739	-	0213-0739	0213-0741
YFM350GW GRIZZLY 2WD 07-11	0213-0740	0213-0740	-	-
YFM350U BIG BEAR 96-97	-	-	0213-0739	0213-0741
YFM350U BIG BEAR 98-99	0213-0739	-	0213-0739	0213-0741
YFM35FX WOLVERINE 95-05	0213-0739	0213-0739	-	-
YFM35X WOLVERINE 06-07	0213-0739	0213-0739	-	-
YFM35X WOLVERINE 08-09	0213-0740	0213-0740	-	-
YFM400 BIG BEAR 2WD 00-04	0213-0740	0213-0739	-	-
YFM400 BIG BEAR 4WD 00-06	0213-0740	0213-0739	-	-
YFM400 BIG BEAR IRS 07-12	0213-0740	0213-0740	-	-
YFM400 GRIZZLY IRS 07	0213-0739	0213-0740	-	-
YFM400 GRIZZLY IRS 08	0213-0740	0213-0740	-	-
YFM400 KODIAK 2WD 00-04	0213-0739	0213-0739	-	-
YFM400 KODIAK 4WD 93-98	0213-0741	0213-0739	-	-
YFM400 KODIAK 4WD 99-06	0213-0739	0213-0739	-	-
450 RHINO 06-09	0213-0747	0213-0743	-	-
KODIAK 450 4WD 18	0213-0740	0213-0740	-	-
KODIAK 450 EPS 4WD 18	0213-0740	0213-0740	-	-

FITS MODEL	WHEEL STUD & NUT KIT FRONT #	WHEEL STUD & NUT KIT REAR #	WHEEL STUD & NUT KIT LEFT REAR #	WHEEL STUD & NUT KIT RIGHT REAR #
WHEEL STUD AND NUT KITS (CON'T)				
YAMAHA (CON'T)				
YFM450 GRIZZLY EPS 11-14	0213-0740	0213-0740	-	-
YFM450 GRIZZLY IRS 07-14	0213-0740	0213-0740	-	-
YFM450 KODIAK 03-06	0213-0739	0213-0739	-	-
YFM45FX WOLVERINE 450 4X4 06-10	0213-0736	0213-0736	-	-
YFM550 GRIZZLY 09-14	0213-0736	0213-0736	-	-
YFM550 GRIZZLY EPS 09-14	0213-0736	0213-0736	-	-
YFM600 GRIZZLY 98-01	0213-0738	-	-	-
660 RHINO 04-07	0213-0741	0213-0743	-	-
YFM660 GRIZZLY 02-08	0213-0738	0213-0738	-	-
700 RHINO FI 08-13	0213-0747	0213-0746	-	-
KODIAK 700 4WD 16-18	0213-0736	0213-0736	-	-
KODIAK 700 EPS 4WD 16-18	0213-0736	0213-0736	-	-
KODIAK 700 EPS 4WD SE 18	0213-0735	0213-0735	-	-
VIKING 700 14-18	0213-0745	0213-0745	-	-
VIKING 700 VI 15-18	0213-0745	0213-0745	-	-
WOLVERINE 17	0213-0744	0213-0744	-	-
WOLVERINE EPS 17	0213-0744	0213-0744	-	-
WOLVERINE R-SPEC EPS 16	0213-0745	0213-0745	-	-
WOLVERINE R-SPEC EPS 17	0213-0744	0213-0744	-	-
WOLVERINE X4 18	0213-0744	0213-0744	-	-
WOLVERINE X4 SE 18	0213-0744	0213-0744	-	-
YFM700 GRIZZLY 07-16	0213-0736	0213-0736	-	-
YFM700 GRIZZLY EPS 08-16	0213-0736	0213-0736	-	-
YFM700 GRIZZLY EPS 17-18	0213-0735	0213-0735	-	-
YXZ1000R 16	0213-0744	0213-0744	-	-
YXZ1000R EPS 17	0213-0744	0213-0744	-	-
YXZ1000R EPS SS 17	0213-0744	0213-0744	-	-

ALUMINUM WHEEL SPACERS

Increase wheel stability by moving wheels out 25.4 mm (1") & 38.1 mm (1 1/2"). Eliminates rubbing against shocks, struts and exhaust.

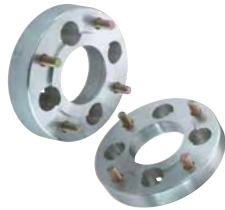

BOLT PATTERN	25.4 MM (1")	50.8 MM (2")	63.5 MM (2-1/2")
4/110 (10MM STUD)	0222-0504	0222-0513	0222-0522
4/110 (12MMX1.25 STUD) ²	0222-0505	0222-0514	0222-0523
4/110 (12MMX1.50 STUD) ⁴	0222-0506	0222-0515	0222-0524
4/115 (10MM STUD)	0222-0507	0222-0516	0222-0525
4/137 (10MM STUD)	0222-0508	0222-0517	0222-0526
4/137 (12MMX1.25 STUD) ³	0222-0509	0222-0518	0222-0527
4/156 (3/8 STUD)	0222-0512	0222-0521	0222-0530
4/156 (12MMX1.50 STUD) ¹	0222-0511	0222-0520	0222-0529
4/156 (12MM X 1.25 STUD) ⁵	0222-0510	0222-0519	0222-0528

¹ RANGER 900 XP ² VIKING ³ TERYX / MULE ⁴ PIONEER / BIG RED ⁵ MULE PRO FXT

TEMP STEM TIRE VALVE

Designed to quickly replace torn, damaged or leaking tire stems. Features a rubber grommet that expands when tightened to prevent popping out and fits a 11.5 mm (0.453") valve stem opening. Simple 60-second install, no need to break the bead or remove the tire. Works on most tubeless rims. Sold in pairs; for off-road use only.



DESCRIPTION	PART #
TEMP STEM TIRE VALVE	0360-0048

POLARIS WHEEL HUB CAP

Replica, replacement plastic wheel hub cap. Simply snaps into place.



FITS MODEL	COLOR	PART #
RZR AND GENERAL MODELS 14-18	BLACK	0214-1532
	RED	0214-1533
	BLUE	0214-1534



ATV/UTV INNER TUBES

High-quality, heavy-duty rubber inner tubes. Heavy-duty valves. Diverse range of sizes. Suitable for use on bias and radial applications.

DESCRIPTION	PLY	PART #	DESCRIPTION	PLY	PART #
ATV/UTV INNER TUBES (CON'T)					
21X9.00-10	TR6	0351-0041	22X10.00-10	TR6	0351-0041
21X9.00-8	TR6	0351-0037	22X10.00-8	TR6	0351-0037
22X10.00-10	TR6	0351-0041	22X10.00-8	TR6	0351-0037
22X10.00-8	TR6	0351-0037	22X11.00-10	TR6	0351-0041
22X11.00-8	TR6	0351-0037	22X11.00-8	TR6	0351-0037
22X11.00-9	TR6	0351-0039	22X11.00-9	TR6	0351-0039
22X12.00-8	TR6	0351-0037	22X12.00-8	TR6	0351-0037
22X7.00-10	TR6	0351-0040	22X7.00-11	TR6	0351-0042
22X7.00-9	TR6	0351-0038	22X8.00-10	TR6	0351-0040
22X8.00-10	TR6	0351-0040	22X8.00-11	TR6	0351-0042
22X8.00-11	TR6	0351-0042	22X9.00-10	TR6	0351-0041
22X9.00-10	TR6	0351-0041	22X9.00-8	TR6	0351-0037
22X9.00-8	TR6	0351-0037	23X10.00-10	TR6	0351-0041
23X10.00-10	TR6	0351-0041	23X10.00-11	TR6	0351-0042
8.00-6/7	TR6	0351-0036	23X10.00-9	TR6	0351-0039
13X5.00-6	JS87P	0351-0035	23X10.50-12	TR6	0351-0042
13X6.50-6	JS87P	0351-0035	23X12.00-10	TR6-OFF	0351-0045
145/70-6	JS87P	0351-0035	23X7.00-10	TR6	0351-0040
14X5.50-6	JS87P	0351-0035	23X8.00-11	TR6	0351-0042
15X6.50-8	TR6	0351-0046	23X8.00-12	TR6	0351-0042
16X6.00-8	TR6	0351-0046	23X8.50-11	TR6	0351-0042
16X6.50-8	TR6	0351-0046	23X9.00-10	TR6	0351-0041
16X7.50-8	TR6	0351-0046	24X10.00-11	TR6	0351-0042
16X8.00-7	TR6	0351-0036	24X10.00-12	TR6	0351-0042
17X7.00-8	TR6	0351-0046	24X11.00-10	TR6	0351-0041
18X10.50-10	TR6	0351-0041	24X11.00-9	TR6	0351-0039
18X11.00-8	TR6	0351-0037	24X12.00-12	TR6	0351-0044
18X6.50-8	TR6	0351-0046	24X13.00-9	TR6	0351-0039
18X7.00-8	TR6	0351-0046	24X13.50-9	TR6	0351-0039
18X7.50-8	TR6	0351-0046	25X8.00-10	TR6-OFF	0351-0045
18X8.50-10	TR6	0351-0041	25X8.00-12	TR6	0351-0042
18X8.50-8	TR6	0351-0037	25X10.00-12	TR6	0351-0044
18X9.50-11	TR6	0351-0037	25X11.00-10	TR6-OFF	0351-0045
19X7.00-8	TR6	0351-0046	25X12.00-10	TR6-OFF	0351-0045
19X8.00-10	TR6	0351-0040	25X12.00-12	TR6	0351-0044
20X10.00-10	TR6	0351-0041	25X12.00-9	TR6	0351-0039
20X10.00-8	TR6	0351-0037	25X13.50-10	TR6-OFF	0351-0045
20X10.00-9	TR6	0351-0039	25X13.50-9	TR6	0351-0039
20X11.00-9	TR6	0351-0039	25X8.00-10	TR6-OFF	0351-0045
20X12.00-9	TR6	0351-0039	25X8.00-12	TR6	0351-0042
20X7.00-8	TR6	0351-0046	26X9X14	TR6	0351-0047
20X7.00-9	TR6	0351-0038	26X11X14	TR6	0351-0048
20X8.00-10	TR6	0351-0041	26X12.00-12	TR6	0351-0044
20X8.00-8	TR6	0351-0037	26X9.00-12	TR6	0351-0043
21X10.00-8	TR6	0351-0037	27X10.00-12	TR6	0351-0043
21X11.00-9	TR6	0351-0039	27X10.50-12	TR6	0351-0043
21X11.00-9	TR6	0351-0039	27X12.00-12	TR6	0351-0044
21X12.00-8	TR6	0351-0037	27X9.50-12	TR6	0351-0043
21X7.00-10	TR6	0351-0040			
21X8.00-10	TR6	0351-0041			
21X8.00-9	TR6	0351-0038			



TIRE CHAINS

V-bar tire chains are available for virtually any ATV. They provide extra pushing/pulling power for any job. Four sizes make installation easy. Tire chains are packaged in a plastic, tackle box style storage case; sold in pairs. Note: Always check clearance after installation.

DESCRIPTION	OVERALL SIZE	PART #
8 V-BARS PER ROW, FITS 21X10X8, 22X11X9, 22X10X10	37 CM (14.5") W X 132 CM (52") L	M91-60008
9 V-BARS PER ROW, FITS 22X11X10, 22X10X12, 25X8X12	37 CM (14.5") W X 137 CM (54") L	M91-60009
10 V-BARS PER ROW, FITS 25X12X9, 25X11X10, 26X10X12	43 CM (17") W X 142 CM (56") L	M91-60010
11 V-BARS PER ROW FOR LARGER, TALLER OVERSIZE TIRES	43 CM (17") W X 168 CM (66") L	0366-0002
REPLACEMENT TIRE CHAIN CASE	-	0366-0003





PLOWS

WINCHES

UTV

RACKS

IMPLEMENTS
& TOWING

LUGGAGE

BODY

CONTROLS

ELECTRICAL

WHEELS
& TIRES

SUSPENSION
& DRIVE

BRAKING

ENGINE

RIDER

GARAGE

PROMO

SUSPENSION & DRIVE

HIGH-PERFORMANCE BALL JOINT KITS

Heavy-Duty Ball Joint Kits feature durable steel on steel design and adjustable end cap, which allows slop to be taken up as they wear. Greased zerk fitting for easy grease delivery.



FITS MODEL	LOWER PART #	UPPER PART #
HIGH-PERFORMANCE BALL JOINT KITS		
CAN-AM		
OUTLANDER DPS 450 EFI 16-18	0430-1035	0430-1036
OUTLANDER L 450 EFI 15-16	0430-1035	0430-1036
OUTLANDER L MAX 450 EFI 15-17	0430-1035	0430-1036
OUTLANDER MAX DPS 450 EFI 16-18	0430-1035	0430-1036
OUTLANDER STD 450 EFI 17-18	0430-1035	0430-1036
DEFENDER 500 & DPS 17-18	0430-1035	-
OUTLANDER 500 STD 4X4 13-15	0430-1035	0430-1036
OUTLANDER 500 XT 4X4 13-14	0430-1035	0430-1036
OUTLANDER L 500 EFI 15	0430-1035	0430-1036
OUTLANDER MAX 500 STD 4X4 13-15	0430-1035	0430-1036
RENEGADE 500 13-15	0430-1035	0430-1036
OUTLANDER DPS 570 EFI 16-18	0430-1035	0430-1036
OUTLANDER L & LE 570 EFI 16	0430-1035	0430-1036
OUTLANDER MAX 570 EFI 16-18	0430-1035	0430-1036
OUTLANDER MAX DPS 570 EFI 16-18	0430-1035	0430-1036
OUTLANDER STD 570 EFI 17-18	0430-1035	0430-1036
OUTLANDER XMR 570 EFI 16-18	0430-1035	0430-1036
OUTLANDER 650 6X6 15	0430-1035	0430-1036
OUTLANDER 650 STD 4X4 13-17 (ALL)	0430-1035	0430-1036
COMMANDER 800 11-18 (ALL)	0430-1035	0430-1036
DEFENDER 800 16	0430-1035	0430-1036
DEFENDER 800 17-18 (ALL)	0430-1035	-
MAVERICK TRAIL 800R 18	0430-1035	-
OUTLANDER 800 (ALL) 4X4 12-15	0430-1035	0430-1036
OUTLANDER 850 (ALL) 16-18	0430-1035	0430-1036
MAVERICK X3 (ALL) 17-18	0430-1035	-
COMMANDER 1000 (ALL) 16-18	0430-1035	0430-1036
COMMANDER MAX 1000 (ALL) 15-18	0430-1035	0430-1036
DEFENDER 1000 16	0430-1035	0430-1036
DEFENDER 1000 (ALL) 17-18	0430-1035	-
DEFENDER MAX 1000 17-18	0430-1035	-
MAVERICK 1000 (ALL) 13-18	0430-1035	0430-1036
MAVERICK MAX 1000 (ALL) 14-18	0430-1035	0430-1036
MAVERICK TRAIL 1000 18	0430-1035	-
OUTLANDER 1000 DPS 12-18	0430-1035	0430-1036
OUTLANDER MAX 1000 13-17	0430-1035	0430-1036
POLARIS		
SPORTSMAN 550 11-13	0430-1034	0430-1034
SPORTSMAN 550 EPS 10-14	0430-1034	0430-1034
SPORTSMAN 550 X2 10-14	0430-1034	0430-1034
SPORTSMAN 550 XP 10-14	0430-1034	0430-1034
SPORTSMAN 550 XP EPS HD INTL 14	0430-1034	0430-1034
SPORTSMAN TOURING 550 EPS 10-14	0430-1034	0430-1034
ACE 570 18	-	0430-1034
RANGER 570 FULL SIZE 15-16	0430-1034	0430-1034
RANGER 570 FULL SIZE CREW 15	0430-1034	0430-1034
RANGER 570 XP 16	0430-1034	0430-1034
RZR 570 EFI 12-19	0430-1034	0430-1034
RANGER 4X4 800 EFI 10-14	0430-1034	0430-1034
RANGER 6X6 800 10-16	0430-1034	0430-1034
RANGER XP 800 12	0430-1034	0430-1034
RZR 4 800 10-14	0430-1034	0430-1034
RZR 800 08-14	0430-1034	0430-1034
RZR S 800 09-14	0430-1034	0430-1034
SPORTSMAN 850 HIGH LIFTER 17-19	0430-1034	0430-1034
SPORTSMAN 850 SP 15-18	0430-1034	0430-1034
SPORTSMAN 850 XP HD EPS MD 15	0430-1034	0430-1034
SPORTSMAN TOURING 850 EPS 13-18	0430-1034	0430-1034
SPORTSMAN X2 850 11	0430-1034	0430-1034
SPORTSMAN XP 850 09-14	0430-1034	0430-1034
ACE 900 EPS XC 17-18	-	0430-1034
BRUTUS HD 900 13-15	0430-1034	0430-1034
RANGER 4X4 900 DIESEL 11-14	0430-1034	0430-1034
RANGER 900 CREW 14-19	0430-1034	0430-1034
RANGER 900 XP 13-19	0430-1034	0430-1034

FITS MODEL	LOWER PART #	UPPER PART #
HIGH-PERFORMANCE BALL JOINT KITS (CON'T)		
POLARIS (CON'T)		
RANGER DIESEL HST/DELUXE 14	0430-1034	0430-1034
RZR 4 900 15-18	0430-1034	0430-1034
RZR 4 XP 900 12-14	0430-1034	0430-1034
RZR 900 50 55 INCH 15-17	0430-1034	0430-1034
RZR 900 50 INCH 18-19	0430-1034	0430-1034
RZR 900 60 INCH 16-19	0430-1034	0430-1034
RZR XP 900 11-14	0430-1034	0430-1034
GENERAL 1000 EPS 16-19	0430-1034	0430-1034
GENERAL 4 1000 EPS 17-18	0430-1034	0430-1034
RANGER 1000 DIESEL 15-18	0430-1034	0430-1034
RANGER 1000 EPS BASE 18-19	-	0430-1034
RANGER HST 15-16	0430-1034	0430-1034
RZR 1000 60 INCH 16-19	0430-1034	0430-1034
RZR RSI 19	0430-1037	0430-1037
RZR S4 1000 19	0430-1034	0430-1034
RZR XP 1000 14-18	0430-1037	0430-1037
RZR XP 4 1000 14-18	0430-1037	0430-1037
RZR XP 4 TURBO 16-17	0430-1037	0430-1037
RZR XP 4 TURBO 19	0430-1037	0430-1037
RZR XP TURBO 16-19	0430-1037	0430-1037
RZR XP TURBO MD 16	0430-1037	0430-1037
SPORTSMAN 1000 HIGH LIFTER 16-18	0430-1034	0430-1034
SPORTSMAN 1000 MD 15	0430-1034	0430-1034
SPORTSMAN 1000 XP 15-18	0430-1034	0430-1034
SPORTSMAN 1000 XP TRACTOR 17-18	0430-1034	0430-1034
SPORTSMAN FOREST 1000 EU 15	0430-1034	0430-1034
SPORTSMAN TOURING 1000 15-18	0430-1034	0430-1034

BALL JOINT AND KING PIN KITS

Ball joint kits offer a considerable cost savings over OEM. Steel housing on some applications replace aluminum joints standard on OEM parts. POM-M90 bearing cup isolates steel rod from housing. OEM does not supply replacement ball joints on many applications. King pin kits are for smaller ATVs where ball joints are not used. Bearings are all hardened steel.



FITS MODEL	BALL JOINT LOWER PART #	BALL JOINT UPPER PART #	KING PIN KIT PART #
BALL JOINT & KING PIN KITS			
ARCTIC CAT			
250 2X4 99-05	0430-0456	0430-0456	-
250 4X4 01-05	0430-0456	0430-0456	-
300 2X4 98-04	0430-0456	0430-0456	-
300 4X4 98-05	0430-0456	0430-0456	-
350 CR 12	0430-0456	0430-0456	-
350 UTILITY 4X4 11	0430-0456	0430-0456	-
366 FIS W/AT 08-11	0430-0456	0430-0456	-
375 2X4/4X4 W/AT 02	0430-0456	0430-0456	-
400 2X4 98-01	0430-0456	0430-0456	-
400 4X4 98-15	0430-0456	0430-0456	-
400 4X4 W/AT 03-04	0430-0456	0430-0456	-
400 4X4 W/MT 01-04	0430-0456	0430-0456	-
400 DVX 04-08	-	0430-0265	-
400 FIS 2X4 W/AT 03-04	0430-0456	0430-0456	-
400 FIS 2X4 W/MT 03-04	0430-0456	0430-0456	-
400 FIS 4X4 TRV 09-14	0430-0456	0430-0456	-
400 FIS 4X4 W/AT 03-14	0430-0456	0430-0456	-
400 FIS 4X4 W/MT 02-08	0430-0456	0430-0456	-
400 TBX 4X4 04-06	0430-0456	0430-0456	-
400 VP 4X4 W/AT 05-06	0430-0456	0430-0456	-
400 VP 4X4 W/MT 05-06	0430-0456	0430-0456	-
425 4X4 11-12	0430-0456	0430-0456	-
450 4X4 14-15	0430-0456	0430-0456	-
450 EFI XC 14-15	0430-0456	0430-0456	-
450 H1 10-11	0430-0456	0430-0456	-
450 TRV 12	0430-0456	0430-0456	-
450I EFI 12	0430-0456	0430-0456	-
450I TRV EFI 11-12	0430-0456	0430-0456	-
450I TRV GT EFI 12	0430-0456	0430-0456	-

FITS MODEL	BALL JOINT LOWER PART #	BALL JOINT UPPER PART #	KING PIN KIT PART #
BALL JOINT & KING PIN KITS (CON'T)			
ARCTIC CAT (CON'T)			
450XC 4X4 11-12	0430-0456	0430-0456	-
454 2X4 97-98	0430-0456	0430-0456	-
454 4X4 96-98	0430-0456	0430-0456	-
500 4X4 98-99	0430-0456	0430-0456	-
500 4X4 W/AT 00-02	0430-0456	0430-0456	-
500 4X4 W/MT 00-01	0430-0456	0430-0456	-
500 EFI 4X4 W/AT 13-16	0430-0456	0430-0456	-
500 FIS 4X4 W/AT 02-09	0430-0456	0430-0456	-
500 FIS 4X4 W/MT 02-09	0430-0456	0430-0456	-
500 FIS TBX 4X4 02-06	0430-0456	0430-0456	-
500 FIS TRV 4X4 03-08	0430-0456	0430-0456	-
500 PROWLER HDX 14-15	0430-0456	0430-0456	-
500 TRV 13-15	0430-0456	0430-0456	-
500 XR 15	0430-0456	0430-0456	-
500 XT EFI 13-14	0430-0456	0430-0456	-
ALTERRA 500 18	0430-0456	0430-0456	-
PROWLER 500 18	0430-0456	0430-0456	-
550 EFI 4X4 12-13	0430-0456	0430-0456	-
550 GT EFI 4X4 12	0430-0456	0430-0456	-
550 HI FIS 4X4 09-11	0430-0456	0430-0456	-
550 PROWLER 09-15	0430-0456	0430-0456	-
550 TRV 4X4 W/AT 09-13	0430-0456	0430-0456	-
550 TRV XT/LTD 14-15	0430-0456	0430-0456	-
550 XR EFI/XT/LTD 15	0430-0456	0430-0456	-
550 XT EFI 4X4 13-14	0430-0456	0430-0456	-
550 XT LTD EFI 12-14	0430-0456	0430-0456	-
650 4X4 HI 05-11	0430-0456	0430-0456	-
650 4X4 HI MUD PRO 10-11	0430-0456	0430-0456	-
650 4X4 W/AT V2 04-06	0430-0456	0430-0456	-
650 HI TBX 07-09	0430-0456	0430-0456	-
650 PROWLER 07	0430-0456	0430-0456	-
650 PROWLER XT 06-09	0430-0456	0430-0456	-
650I 4X4 12	0430-0456	0430-0456	-
ALTERRA 700 18	0430-0456	0430-0456	-
ALTERRA 700 VLX 18	0430-0456	0430-0456	-
ALTERRA 700 VLX EPS 18	0430-0456	0430-0456	-
ALTERRA 700 XT EPS 18	0430-0456	0430-0456	-
700 DIESEL 07-15	0430-0456	0430-0456	-
700 EFI 06-08	0430-0456	0430-0456	-
700 EFI / LTD 11-14	0430-0456	0430-0456	-
700 EFI HI 08-11	0430-0456	0430-0456	-
700 EFI HI MUDPRO 09-11	0430-0456	0430-0456	-
700 GT EFI 12	0430-0456	0430-0456	-
700 LTD EFI 13	0430-0456	0430-0456	-
700 PROWLER HDX 12-14	0430-0456	0430-0456	-
700 PROWLER HDX XT 15-16	0430-0456	0430-0456	-
700 PROWLER XT 09-15	0430-0456	0430-0456	-
700 PROWLER TX 08-14	0430-0456	0430-0456	-
700 TBX 10-15	0430-0456	0430-0456	-
700 TBX 18	0430-0456	0430-0456	-
700 TRV 08-15	0430-0456	0430-0456	-
700 XR 15	0430-0456	0430-0456	-
700 XT 13-14	0430-0456	0430-0456	-
700I EFI MUD PRO / LTD 12-15	0430-0456	0430-0456	-
700I HI TRV GT EFI 11-12	0430-0456	0430-0456	-
WILDCAT SPORT 15	0430-0456	0430-0456	-
WILDCAT TRAIL / XT 14-15	0430-0456	0430-0456	-
1000 LTD MUDPRO 15	0430-0456	0430-0456	-
1000 PROWLER XT 15	0430-0456	0430-0456	-
1000 PROWLER XTZ 11-14	0430-0456	0430-0456	-
1000 PROWLER XTZ H2 09-11	0430-0456	0430-0456	-
1000 TRV 13	0430-0456	0430-0456	-
1000 TRV / CRUISER 09-12	0430-0456	0430-0456	-
1000 TRV GT 12	0430-0456	0430-0456	-
1000 TRV XT/LTD 15	0430-0456	0430-0456	-
1000 XT 13-16	0430-0456	0430-0456	-
1000I GT 12	0430-0456	0430-0456	-
1000I LTD EFI MUD PRO 12-14	0430-0456	0430-0456	-
H2 MUD PRO 10-11	0430-0456	0430-0456	-
H2 THUNDERCAT 08-11	0430-0456	0430-0456	-
WILDCAT SPORT 18	0430-0456	0430-0456	-
WILDCAT TRAIL / XT 18	0430-0456	0430-0456	-
WILDCAT 4X LTD 18	0430-0456	0430-0456	-
WILDCAT X EPS 18	0430-0456	0430-0456	-

FITS MODEL	BALL JOINT LOWER PART #	BALL JOINT UPPER PART #	KING PIN KIT PART #
BALL JOINT & KING PIN KITS (CON'T)			
ARCTIC CAT (CON'T)			
WILDCAT X LTD EPS 18	0430-0456	0430-0456	-
WILDCAT XX EPS 18	0430-0456	0430-0456	-
WILDCAT 1000 14-15	0430-0456	0430-0456	-
WILDCAT 1000 LATE BUILD 13	0430-0456	0430-0456	-
WILDCAT 4 13-14	0430-0456	0430-0456	-
WILDCAT 4 LTD 14	0430-0456	0430-0456	-
WILDCAT 4X 14-15	0430-0456	0430-0456	-
WILDCAT GT 12-13	0430-0456	0430-0456	-
WILDCAT LTD 13-14	0430-0456	0430-0456	-
WILDCAT X 13	0430-0456	0430-0456	-
WILDCAT X / LTD 14-15	0430-0456	0430-0456	-
CAN-AM			
OUTLANDER 330 04-05	-	0430-0562	-
OUTLANDER 400 03-04	-	0430-0562	-
OUTLANDER 400 STD 2X4 05	-	0430-0562	-
OUTLANDER 400 STD 4X4 05	-	0430-0562	-
OUTLANDER 400 STD 4X4 06-15	0430-0606	0430-0562	-
OUTLANDER 400 XT 4X4 05	-	0430-0562	-
OUTLANDER 400 XT 4X4 06-14	0430-0606	0430-0562	-
OUTLANDER MAX 400 EFI/STD/XT 15	0430-0606	0430-0562	-
OUTLANDER MAX 400 STD 4X4 05	-	0430-0562	-
OUTLANDER MAX 400 STD 4X4 06-14	0430-0606	0430-0562	-
OUTLANDER MAX 400 XT 4X4 06-14	0430-0606	0430-0562	-
OUTLANDER L 450 EFI 15	0430-0664	0430-0738	-
OUTLANDER L MAX 450 EFI 15	0430-0664	0430-0738	-
OUTLANDER DPS 450 EFI 16-17	0430-0664	0430-0738	-
OUTLANDER MAX DPS 450 EFI 16-17	0430-0664	0430-0738	-
OUTLANDER 500 EFI 15	0430-0664	0430-0738	-
OUTLANDER 500 LTD 4X4 10	0430-0606	0430-0562	-
OUTLANDER 500 STD 4X4 07-12	0430-0606	0430-0562	-
OUTLANDER 500 STD 4X4 13-14	0430-0664	0430-0738	-
OUTLANDER 500 XT 4X4 07-12	0430-0606	0430-0562	-
OUTLANDER 500 XT 4X4 13-14	0430-0664	0430-0738	-
OUTLANDER L 500 EFI 15	0430-0664	0430-0738	-
OUTLANDER L MAX 500 EFI 15	0430-0664	0430-0738	-
OUTLANDER MAX 500 EFI 15	0430-0664	0430-0738	-
OUTLANDER MAX 500 STD 4X4 07-12	0430-0606	0430-0562	-
OUTLANDER MAX 500 STD 4X4 13-14	0430-0664	0430-0738	-
OUTLANDER MAX 500 XT 4X4 07-12	0430-0606	0430-0562	-
OUTLANDER MAX 500 XT 4X4 13-14	0430-0664	0430-0738	-
QUEST 500 02-04	0430-0605	0430-0605	-
QUEST 500 XT 02-04	0430-0605	0430-0605	-
RENEGADE 500 08-12	0430-0605	0430-0605	-
RENEGADE 500 13-15	0430-0664	0430-0738	-
RENEGADE 500 XT 12	0430-0605	0430-0605	-
TRAXTER 500 99-05	0430-0605	0430-0605	-
TRAXTER 500 AUTO CVT 05	0430-0605	0430-0605	-
OUTLANDER DPS 570 EFI 16-19	0430-0664	0430-0738	-
OUTLANDER X MR 570 EFI 16-19	0430-0664	0430-0738	-
RENEGADE 570 EFI 16-19	0430-0664	0430-0738	-
OUTLANDER 650 6X6 15	0430-0664	0430-0738	-
OUTLANDER 650 STD 4X4 06-12	0430-0606	0430-0605	-
OUTLANDER 650 STD 4X4 13-15	0430-0664	0430-0738	-
OUTLANDER 650 XMR 13-15	0430-0664	0430-0738	-
OUTLANDER 650 XT 4X4 06-12	0430-0606	0430-0605	-
OUTLANDER 650 XT 4X4 13-14	0430-0664	0430-0738	-
OUTLANDER MAX 650 EFI 15	0430-0664	0430-0738	-
OUTLANDER MAX 650 STD 4X4 06-12	0430-0606	0430-0605	-
OUTLANDER MAX 650 STD 4X4 13-19	0430-0664	0430-0738	-
OUTLANDER MAX 650 XT 4X4 06-12	0430-0606	0430-0605	-
OUTLANDER MAX 650 XT 4X4 13-14	0430-0664	0430-0738	-
OUTLANDER DPS 650 EFI 2017	0430-0664	0430-0738	-
QUEST 650 STD / XT 02-04	0430-0605	0430-0605	-
TRAXTER 650 04-05	0430-0605	0430-0605	-
TRAXTER 650 AUTO CVT 05	0430-0605	0430-0605	-
COMMANDER 800 11-15	0430-0664	0430-0738	-
OUTLANDER 800 STD 4X4 06-08	0430-0606	0430-0605	-
OUTLANDER 800 XMR 11-12	0430-0606	0430-0605	-
OUTLANDER 800 XT 4X4 06-08	0430-0606	0430-0605	-
OUTLANDER 800 XXC 11	0430-0606	0430-0605	-
OUTLANDER 800R EFI 15	0430-0664	0430-0738	-
OUTLANDER 800R EFI XMR 15	0430-0664	0430-0738	-
OUTLANDER 800R STD 4X4 09-11	0430-0606	0430-0605	-
OUTLANDER 800R STD 4X4 12-14	0430-0664	0430-0738	-

PLOWES
WINCHES
UTV
RACKS
IMPLEMENTES & TOWING
LUGGAGE
BODY
CONTROLS
ELECTRICAL
WHEELS & TIRES
SUSPENSION & DRIVE
BRAKING
ENGINE
RIDER
GARAGE
PROMO

SUSPENSION & DRIVE

FITS MODEL	BALL JOINT LOWER PART #	BALL JOINT UPPER PART #	KING PIN KIT PART #
BALL JOINT & KING PIN KITS (CON'T)			
CAN-AM (CON'T)			
OUTLANDER 800R XT 4X4 09-12	0430-0606	0430-0605	-
OUTLANDER 800R XT 4X4 13-14	0430-0664	0430-0738	-
OUTLANDER MAX 800 LTD 4X4 07-08	0430-0606	0430-0605	-
OUTLANDER MAX 800 STD 4X4 06-08	0430-0606	0430-0605	-
OUTLANDER MAX 800 XT 4X4 06-08	0430-0606	0430-0605	-
OUTLANDER MAX 800R EFI 15	0430-0664	0430-0738	-
OUTLANDER MAX 800R LTD 4X4 09-12	0430-0606	0430-0605	-
OUTLANDER MAX 800R STD 4X4 09-11	0430-0606	0430-0605	-
OUTLANDER MAX 800R STD 4X4 12-14	0430-0664	0430-0738	-
OUTLANDER MAX 800R XT 4X4 09-12	0430-0606	0430-0605	-
OUTLANDER MAX 800R XT 4X4 13-14	0430-0664	0430-0738	-
RENEGADE 800 07-11	0430-0605	0430-0605	-
RENEGADE 800 12-15	0430-0664	0430-0738	-
RENEGADE 800 X 08-09	0430-0605	0430-0605	-
RENEGADE 800 XXC 10-11	0430-0605	0430-0605	-
RENEGADE 800 XXC 12-14	0430-0664	0430-0738	-
COMMANDER MAX 800 DPS 17	0430-0664	0430-0738	-
DEFENDER 800 17-19	0430-0664	-	-
DEFENDER 800 XT/DPS 17-19	0430-0664	-	-
COMMANDER 800 STD 11-19	0430-0664	0430-0738	-
COMMANDER 800 XT 11-17	0430-0664	0430-0738	-
COMMANDER 800 DPS 13-17	0430-0664	0430-0738	-
OUTLANDER DPS 850 EFI 17-19	0430-0664	0430-0738	-
OUTLANDER MAX DPS 850 EFI 17-19	0430-0664	0430-0738	-
RENEGADE 850 16-19	0430-0664	0430-0738	-
RENEGADE 850 XXC 16-19	0430-0664	0430-0738	-
COMMANDER 1000 11-15	0430-0664	0430-0738	-
COMMANDER 1000 DPS 16-19	0430-0664	0430-0738	-
COMMANDER 1000 LTD 16-19	0430-0664	0430-0738	-
COMMANDER 1000 STD 11-19	0430-0664	0430-0738	-
COMMANDER 1000 XT 16-19	0430-0664	0430-0738	-
COMMANDER 1000 XTP 14-19	0430-0664	0430-0738	-
COMMANDER MAX 1000 14-19	0430-0664	0430-0738	-
COMMANDER MAX 1000 XT/DPS/LTD 14-19	0430-0664	0430-0738	-
DEFENDER 1000 17-19	0430-0664	-	-
DEFENDER 1000 XT/DPS 17-19	0430-0664	-	-
DEFENDER MAX 1000 XT/DPS 17-19	0430-0664	-	-
MAVERICK 1000 13-15	0430-0664	0430-0738	-
MAVERICK 1000 TURBO 17-19	0430-0664	0430-0738	-
MAVERICK 1000 XC/XXC/DPS 17-19	0430-0664	0430-0738	-
MAVERICK 1000 XDS-DPS 15-19	0430-0664	0430-0738	-
MAVERICK 1000 XMR 15	0430-0664	0430-0738	-
MAVERICK 1000 XMR 14-17	0430-0664	0430-0738	-
MAVERICK 1000 XXC 15	0430-0664	0430-0738	-
MAVERICK MAX 1000 14-15	0430-0664	0430-0738	-
MAVERICK MAX 1000 DPS 17	0430-0664	0430-0738	-
MAVERICK MAX 1000 TURBO 17-19	0430-0664	0430-0738	-
MAVERICK MAX 1000 XMR 17-19	0430-0664	0430-0738	-
MAVERICK X3 17-19	0430-0664	0430-0739	-
OUTLANDER 1000 EFI 15	0430-0664	0430-0738	-
OUTLANDER 1000 EFI 6X6 15	0430-0664	0430-0738	-
OUTLANDER 1000 EFI XMR 15	0430-0664	0430-0738	-
OUTLANDER 1000 STD 4X4 12-14	0430-0664	0430-0738	-
OUTLANDER 1000 XMR 13-14	0430-0664	0430-0738	-
OUTLANDER 1000 XT 4X4 12-14	0430-0664	0430-0738	-
OUTLANDER DPS 1000 EFI 17	0430-0664	0430-0738	-
OUTLANDER MAX 1000 EFI 15	0430-0664	0430-0738	-
OUTLANDER MAX 1000 EFI LTD 15	0430-0664	0430-0738	-
OUTLANDER MAX 1000 STD 4X4 13-14	0430-0664	0430-0738	-
OUTLANDER MAX 1000 XT 4X4 13-14	0430-0664	0430-0738	-
OUTLANDER X MR DPS 1000 EFI 17	0430-0664	0430-0738	-
RENEGADE 1000 12-17	0430-0664	0430-0738	-
RENEGADE 1000 X MR 16-17	0430-0664	0430-0738	-
RENEGADE 1000 XXC 12-17	0430-0664	0430-0738	-
RENEGADE 1000 12-15	0430-0664	0430-0738	-
RENEGADE 1000 XXC 12-14	0430-0664	0430-0738	-
CF-MOTO			
RANCHER 500 CF500-5 UTV 11-13	0430-0255	0430-0255	-
RANCHER 600 CF600-5 UTV 11-13	0430-0255	0430-0255	-
Z6 TERRACROSS 600 11-14	-	0430-0255	-
Z6-EX TERRACROSS 625 EX 12-14	0430-0255	0430-0255	-
TRACKER 800 CF800-3 UTV 13-14	-	0430-0255	-
Z8-EX TERRACROSS 800 EX 14	0430-0456	0430-0255	-
TRX90 93-19	-	-	0430-0258

FITS MODEL	BALL JOINT LOWER PART #	BALL JOINT UPPER PART #	KING PIN KIT PART #
BALL JOINT & KING PIN KITS (CON'T)			
HONDA			
TRX125 87-88	-	-	0430-0258
TRX200 90-97	-	-	0430-0259
TRX200D 90-97	-	-	0430-0259
TRX200SX 86-88	-	-	0430-0256
TRX250 RECON 97-01	0430-0254	0430-0255	-
TRX250TE RECON 02-19	0430-0254	0430-0255	-
TRX300 FOURTRAX 88-92	-	0430-0562	-
TRX300 FOURTRAX 93-00	0430-0255	0430-0255	-
TRX300FW FOURTRAX 4X4 88-00	0430-0255	0430-0255	-
TRX350FE 00-06	0430-0255	0430-0261	-
TRX350FM FOURTRAX RANCHER 00-06	0430-0255	0430-0261	-
TRX350TE 00-06	0430-0255	0430-0261	-
TRX350TM FOURTRAX RANCHER 00-06	0430-0255	0430-0261	-
TRX400FA 04-07	0430-0255	0430-0261	-
TRX400FGA FOURTRAX RANCHER 4X4 04-07	0430-0255	0430-0261	-
TRX400FW FOURTRAX FOREMAN 4X4 95-03	0430-0255	0430-0255	-
TRX420 FA 09-14	0430-0255	0430-0261	-
TRX420 FA 15-16	0430-0261	0430-0261	-
TRX420 FA IRS 15-19	0430-0261	0430-0261	-
TRX420 FE 07-13	0430-0255	0430-0261	-
TRX420 FE 14-19	0430-0261	0430-0261	-
TRX420 FM 07-13	0430-0255	0430-0261	-
TRX420 FM 14-19	0430-0261	0430-0261	-
TRX420 FPA 09-14	0430-0255	0430-0261	-
TRX420 FPE 11-13	0430-0255	0430-0261	-
TRX420 FPM 11-13	0430-0255	0430-0261	-
TRX420 TE 07-13	0430-0255	0430-0261	-
TRX420 TE 14-19	0430-0261	0430-0261	-
TRX420 TM 07-13	0430-0255	0430-0261	-
TRX420 TM 14-19	0430-0261	0430-0261	-
TRX450ES 98-01	0430-0261	0430-0261	-
TRX450FE/FM 02-04	0430-0261	0430-0261	-
TRX450S 98-01	0430-0261	0430-0261	-
PIONEER 500 SXS500M 15-17	0430-1019	0430-0261	-
TRX500 FM IRS 15-19	0430-0261	-	-
TRX500FA 01-19	0430-0261	0430-0261	-
TRX500FE 05-15	0430-0261	0430-0261	-
TRX500FGA 04-08	0430-0261	0430-0261	-
TRX500FM 05-15	0430-0261	0430-0261	-
TRX500FPA 09-14	0430-0261	0430-0261	-
TRX500FPE 07-13	0430-0261	0430-0261	-
TRX500FPM 08-13	0430-0261	0430-0261	-
TRX500TM 05-06	0430-0261	0430-0261	-
TRX650 RINCON 03-05	0430-0261	0430-0261	-
TRX680 RINCON 06-19	0430-0261	0430-0261	-
BIG RED MUV 700 09-13	0430-1019	-	-
PIONEER 700 SXS700M2 14-19	0430-1019	0430-1022	-
PIONEER 700-4 SXS700M4 14-19	0430-1019	0430-1022	-
PIONEER 700 SXS700M2 14-19	0430-1019	0430-1022	-
PIONEER 700-4 SXS700M4 14-19	0430-1019	0430-1022	-
PIONEER 1000MS 16-19	-	0430-0261	-
JOHN DEERE			
BUCK UTILITY 500 ALL	0430-0605	0430-0605	-
TRAIL BUCK UTILITY 500 ALL	0430-0605	0430-0605	-
TRAIL BUCK 650 ALL	0430-0255	0430-0255	-
TRAIL BUCK 650EX ALL	0430-0255	0430-0255	-
TRAIL BUCK 650EXT ALL	0430-0255	0430-0255	-
KAWASAKI			
KFX50 03-06	-	-	0430-0252
KFX80 03-06	-	-	0430-0251
KLF220 BAYOU 88-02	-	-	0430-0257
KLF250 BAYOU 03-11	-	-	0430-0257
KLF300A BAYOU 86-87	0430-0264	0430-0264	-
KLF300B BAYOU 88-04	0430-0264	0430-0264	-
KLF300C BAYOU 4X4 89-05	0430-0262	0430-0263	-
KVF300A PRAIRIE 4X4 99-00	0430-0262	0430-0562	-
KVF300B PRAIRIE 4X4 01-02	0430-0266	0430-0562	-
KVF300C PRAIRIE 2X4 99-00	0430-0262	0430-0562	-
KVF300D PRAIRIE 2X4 01-02	0430-0266	0430-0562	-
KVF360A & C PRAIRIE 4X4 03-13	0430-0308	0430-0562	-
KVF360B PRAIRIE 03-10	0430-0308	0430-0562	-
KLF400 BAYOU 93-99	0430-0262	0430-0263	-
KVF400A PRAIRIE 4X4 97-98	0430-0262	0430-0562	-
KVF400B PRAIRIE 98	0430-0262	0430-0562	-

FITS MODEL	BALL JOINT LOWER PART #	BALL JOINT UPPER PART #	KING PIN KIT PART #
BALL JOINT & KING PIN KITS (CON'T)			
KAWASAKI (CON'T)			
KVF400C PRAIRIE 4X4 99-00	0430-0262	0430-0562	-
KVF400C PRAIRIE 4X4 01-02	0430-0266	0430-0562	-
KVF400D PRAIRIE 99-00	0430-0262	0430-0562	-
KVF400D PRAIRIE 01-02	0430-0266	0430-0562	-
MULE 600 05-16	0430-0663	-	-
MULE 610 4X4 05-16	0430-0663	-	-
MULE 610 4X4 VIN JK1AFE1 9B547191 AND LOWER 09	0430-0663	-	-
MULE 610 4X4 VIN JK1AFE1 9B547192 AND ABOVE 09	0430-0663	-	-
KFX450R 08-14	0430-0308	0430-0308	-
MULE 2500 94-00	0430-0663	-	-
MULE 2510 4X4 93-00	0430-0663	-	-
MULE 2520 93-00	0430-0663	-	-
MULE 3000 01-08	0430-0663	-	-
MULE 3010 4X4 01-08	0430-0663	-	-
MULE 3020 01-03	0430-0663	-	-
MULE 4000 09-16	0430-0663	-	-
MULE 4010 4X4 09-16	0430-0663	-	-
KVF650 BRUTE FORCE 05-13	0430-0308	0430-0562	-
KVF650 I BRUTE FORCE 06-13	0430-0308	0430-0308	-
KVF650 PRAIRIE 02-03	0430-0308	0430-0562	-
KFX700 V-FORCE 04-09	0430-0308	0430-0308	-
KVF700 PRAIRIE 04-06	0430-0308	0430-0562	-
KVF750 BRUTE FORCE 05-16	0430-0308	0430-0308	-
KVF750 BRUTE FORCE EPS 12-19	0430-0308	0430-0308	-
TERYX 4 4X4 12-13	0430-0308	0430-0308	-
TERYX 750 4X4 08-13	0430-0308	0430-0308	-
TERYX 800 4 4X4 14-19	0430-0308	0430-0308	-
TERYX 800 4X4 14-19	0430-0308	0430-0308	-
MULE PRO-MX 19	0430-0308	0430-0308	-
MULE 2510 DIESEL 00-02	-	0430-0663	-
MULE 3010 DIESEL 01-08	-	0430-0663	-
MULE 4010 4X4 DIESEL 09-19	0430-0663	-	-
MULE 4010 4X4 DIESEL 11-13	-	0430-0663	-
KYMCO			
MXU 375 09-10	0430-0456	0430-0456	-
MXU 400 ALL	0430-0456	0430-0456	-
MAXXER 450I ALL	0430-0456	0430-0456	-
MXU 450I ALL	0430-0456	0430-0456	-
MXU 500I ALL	0430-0456	0430-0456	-
UXV 500 2009- 2011	0430-0456	0430-0456	-
UXV 500I ALL	0430-0456	0430-0456	-
POLARIS			
BRUTUS HD PTO 13-15	0430-0563	0430-0563	-
LSV ELECTRIC 4X4 11-12	0430-0272	-	-
RANGER EV 4X4 10-16	0430-0272	-	-
PHOENIX 200 05-16	0430-0273	0430-0273	-
SAWTOOTH 200 06-07	0430-0273	0430-0273	-
BIG BOSS 250 4X6 89-92	0430-0272	-	-
BIG BOSS 250 6X6 91-93	0430-0272	-	-
TRAIL BLAZER 250 90-06	0430-0272	-	-
TRAIL BOSS 250 2X4 88-99	0430-0272	-	-
TRAIL BOSS 250 4X4 89-95	0430-0272	-	-
XPLORER 250 4X4 00-02	0430-0272	-	-
300 2X4 94-95	0430-0272	-	-
300 4X4 94-95	0430-0272	-	-
BIG BOSS 300 6X6 94	0430-0272	-	-
HAWKEYE 2X4 06-11	0430-0563	-	-
HAWKEYE 4X4 06-07	0430-0563	-	-
SPORTSMAN 300 4X4 08-10	0430-0563	-	-
XPLORER 300 4X4 96-99	0430-0272	-	-
XPRESS 300 96-99	0430-0272	-	-
MAGNUM 325 2X4 00-02	0430-0272	-	-
MAGNUM 325 4X4 00-02	0430-0272	-	-
MAGNUM 325 4X4 HDS 02	0430-0272	-	-
MAGNUM 325 4X4 HDS AA 01	0430-0272	-	-
MAGNUM 325 4X4 HDS FB 01	0430-0272	-	-
SPORTSMAN ACE 325 14-16	0430-0272	-	-
XPEDITION 325 00-02	0430-0272	-	-
HAWKEYE 325 2X4 15	0430-1021	-	-
RANGER ETX 325 15-16	0430-1021	-	-
SPORTSMAN ACE 325 HD 15	0430-1021	-	-
ATP 330 4X4 04-05	0430-0272	-	-
MAGNUM 330 2X4 03-05	0430-0272	-	-
SPORTSMAN ETX EFI 325 15	0430-0272	-	-

FITS MODEL	BALL JOINT LOWER PART #	BALL JOINT UPPER PART #	KING PIN KIT PART #
BALL JOINT & KING PIN KITS (CON'T)			
POLARIS (CON'T)			
TRAIL BOSS 325 00-02	0430-0272	-	-
MAGNUM 330 4X4 05	0430-0272	-	-
MAGNUM 330 4X4 AA AB AC 03-04	0430-0272	-	-
MAGNUM 330 4X4 FB 03-04	0430-0272	-	-
TRAIL BLAZER 330 08-13	0430-0272	-	-
TRAIL BOSS 330 03-13	0430-0272	-	-
SPORTSMAN 335 99-00	0430-0272	-	-
WORKER 335 99	0430-0272	-	-
350L 2X4 93	0430-0272	-	-
350L 4X4 93	0430-0272	-	-
BIG BOSS 350L 6X6 93	0430-0272	-	-
SPORTSMAN 350 4X4 93	0430-0272	-	-
TRAIL BOSS 350L 2X4 90-92	0430-0272	-	-
TRAIL BOSS 350L 4X4 90-92	0430-0272	-	-
400L 2X4 94-95	0430-0272	-	-
400L 4X4 94	0430-0272	-	-
BIG BOSS 400L 6X6 94-97	0430-0272	-	-
HAWKEYE 400 HO 2X4 11	0430-0563	-	-
HAWKEYE 400 HO 2X4 12-14	0430-0272	-	-
MAGNUM 400L 6X6 96-97	0430-0272	-	-
RANGER 4X4 400 10-14	0430-0272	-	-
SCRAMBLER 400 2X4 00-02	0430-0272	-	-
SCRAMBLER 400 4X4 95-02	0430-0272	-	-
SPORT 400 94-99	0430-0272	-	-
SPORTSMAN 400 4X4 94-05	0430-0272	-	-
SPORTSMAN 400 4X4 AA AE AG 04	0430-0272	-	-
SPORTSMAN 400 4X4 01	0430-0272	-	-
SPORTSMAN 400 4X4 AQ-AV 04	0430-0272	-	-
SPORTSMAN 400 HO 4X4 09-10	0430-0563	-	-
SPORTSMAN 400 HO 4X4 11-14	0430-0272	-	-
SPORTSMAN 400 HO 4X4 08	0430-0563	-	-
TRAIL BLAZER 400 03	0430-0272	-	-
XPLORER 400L 4X4 95-02	0430-0272	-	-
XPRESS 400L 2X4 96-97	0430-0272	-	-
MAGNUM 425 2X4 95-98	0430-0272	-	-
MAGNUM 425 4X4 95-98	0430-0272	-	-
XPEDITION 425 00-02	0430-0272	-	-
SPORTSMAN 450 06-07	0430-0272	-	-
SPORTSMAN 450 HO 16	0430-0272	-	-
DIESEL 455 4X4 00-01	0430-0272	-	-
DIESEL 455 4X4 (AFTER 9/98) 99	0430-0272	-	-
ATP 500 4X4 04-05	0430-0272	-	-
ATV 500 PRO 02	0430-0272	-	-
BIG BOSS 500 6X6 98-03	0430-0272	-	-
MAGNUM 500 2X4 HDS 02	0430-0272	-	-
MAGNUM 500 4X4 99-01	0430-0272	-	-
MAGNUM 500 4X4 AA 02	0430-0272	-	-
MAGNUM 500 4X4 AB/FB 02	0430-0272	-	-
MAGNUM 500 4X4 HDS 03	0430-0272	-	-
MAGNUM 500 4X4 HDS AA 01-02	0430-0272	-	-
MAGNUM 500 4X4 HDS AB/FB 02	0430-0272	-	-
MAGNUM 500 4X4 HDS FB 01	0430-0272	-	-
ORANGER 2X4 500 05-09	0430-0272	-	-
RANGER 4X4 500 99-08	0430-0272	-	-
RANGER 4X4 500 09-10	0430-0563	0430-0563	-
RANGER 4X4 500 11-13	0430-0272	-	-
RANGER 4X4 500 CREW 11-13	0430-0272	-	-
RANGER 4X4 500 EFI 06	0430-0272	-	-
RANGER 6X6 500 02-05	0430-0272	-	-
RANGER SERIES 10 4X4 & 6X6 07	0430-0272	-	-
RANGER SERIES 11 4X4 & 6X6 07	0430-0272	-	-
SCRAMBLER 500 2X4 00-08	0430-0272	-	-
SCRAMBLER 500 4X4 97-12	0430-0272	-	-
SPORTSMAN 500 6X6 00-08	0430-0272	-	-
SPORTSMAN 500 EFI 09	0430-0272	-	-
SPORTSMAN 500 X2 06-09	0430-0272	-	-
SPORTSMAN FOREST 500 11-13	0430-0272	-	-
SPORTSMAN FOREST TRACTOR 500 11-14	0430-0272	-	-
SPORTSMAN TOURING 500 08-13	0430-0272	-	-
XPLORER 500 97	0430-0272	-	-
OUTLAW 525 IRS 07-11	0430-0457	0430-0457	-
OUTLAW 525 S 08-10	0430-0457	0430-0457	-
SPORTSMAN 550 11-13	0430-0563	0430-0563	-
SPORTSMAN 550 EPS 10-14	0430-0563	0430-0563	-

PLOWES
WINCHES
UTV
RACKS
IMPLEMENTES & TOWING
LUGGAGE
BODY
CONTROLS
ELECTRICAL
WHEELS & TIRES
SUSPENSION & DRIVE
BRAKING
ENGINE
RIDER
GARAGE
PROMO

SUSPENSION & DRIVE

FITS MODEL	BALL JOINT LOWER PART #	BALL JOINT UPPER PART #	KING PIN KIT PART #
BALL JOINT & KING PIN KITS (CON'T)			
POLARIS (CON'T)			
SPORTSMAN 500 4X4 96-00	0430-0272	-	-
SPORTSMAN 500 4X4 DUSE 01-02	0430-0272	-	-
SPORTSMAN 500 4X4 HO 01-13	0430-0272	-	-
SPORTSMAN 500 4X4 HO AA- AC- AE- AG 04	0430-0272	-	-
SPORTSMAN 500 4X4 HO AD- AX 04	0430-0272	-	-
SPORTSMAN 500 4X4 RSE 99-02	0430-0272	-	-
SPORTSMAN 550 X2 10-14	0430-0563	0430-0563	-
SPORTSMAN 550 XP 13-14	0430-0563	0430-0563	-
SPORTSMAN FOREST 550 11-14	0430-0563	0430-0563	-
SPORTSMAN TOURING EPS 550 10-14	0430-0563	0430-0563	-
SPORTSMAN XP 550 09-10	0430-0563	0430-0563	-
RANGER 4X4 570 14	0430-0272	-	-
RANGER 4X4 570 CREW 14-15	0430-0272	-	-
RANGER 4X4 570 FULL SIZE / CREW 15-16	0430-0563	0430-0563	-
RZR 570 EFI 12-15	0430-0563	0430-0563	-
SPORTSMAN 570 EFI 14-16	0430-0272	-	-
SPORTSMAN 570 EFI EPS 14-15	0430-0272	-	-
SPORTSMAN 570 EFI EPS FOREST QUAD 15-19	0430-0272	-	-
SPORTSMAN 570 EFI HD 14	0430-0272	-	-
SPORTSMAN 570 EFI X2 15-16	0430-0272	-	-
SPORTSMAN 570 FOREST 14-19	0430-0272	-	-
SPORTSMAN 570 FOREST EFI EPS 14-19	0430-0272	-	-
SPORTSMAN 570 SP 15	0430-0272	-	-
SPORTSMAN 570 SP EPS TRACTOR 15	0430-0272	-	-
SPORTSMAN 570 SP TOURING 15	0430-0272	-	-
SPORTSMAN 570 TOURING EFI 14-16	0430-0272	-	-
SPORTSMAN 570 SP 15-19	0430-1020	-	-
SPORTSMAN 570 SP TOURING 16-19	0430-1020	-	-
RANGER 4X4 570 15	0430-1021	-	-
SPORTSMAN 570 EFI UTE HD 15-17	0430-1021	-	-
SPORTSMAN 570 HD 15-17	0430-1021	-	-
SPORTSMAN ACE 570 15	0430-1021	-	-
SPORTSMAN 600 4X4 03-05	0430-0272	-	-
RANGER 4X4 700 05-08	0430-0272	-	-
RANGER 4X4 700 09	0430-0563	0430-0563	-
RANGER 4X4 700 CREW 08-09	0430-0272	-	-
RANGER 6X6 700 EFI 06-09	0430-0272	-	-
SPORTSMAN 700 4X4 02-07	0430-0272	-	-
SPORTSMAN 700 EFI 05-07	0430-0272	-	-
SPORTSMAN X2 700 EFI 08	0430-0272	-	-
SPORTSMAN FOREST 800 6X6 15	0430-0272	-	-
RANGER 4X4 800 EFI 10-14	0430-0563	0430-0563	-
RANGER 4X4 800 EFI CREW 10-14	0430-0563	0430-0563	-
RANGER 4X4 800 EFI MID SIZE 13-14	0430-0272	-	-
RANGER 6X6 800 10-16	0430-0563	0430-0563	-
RANGER XP 800 12	0430-0563	0430-0563	-
RZR 4 800 10-14	0430-0563	0430-0563	-
RZR 800 08-14	0430-0563	0430-0563	-
RZR S 800 09-14	0430-0563	0430-0563	-
SPORTSMAN 800 EFI 05-14	0430-0272	-	-
SPORTSMAN 800 EFI 6X6 09-14	0430-0272	-	-
SPORTSMAN FOREST 800 6X6 13	0430-0272	-	-
SPORTSMAN FOREST 800 EFI 12-14	0430-0272	-	-
SPORTSMAN TOURING 800 EFI 08-09	0430-0272	-	-
SPORTSMAN X2 800 EFI 07-09	0430-0272	-	-
SCRAMBLER 850 15-16	0430-0563	0430-0563	-
SCRAMBLER HO/ EPS 850 13-14	0430-0563	0430-0563	-
SPORTSMAN 850 SP 15-16	0430-0563	0430-0563	-
SPORTSMAN 850 WV 14	0430-0457	0430-0457	-
SPORTSMAN FOREST 850 11-15	0430-0563	0430-0563	-
SPORTSMAN TOURING 850 SP 15-16	0430-0563	0430-0563	-
SPORTSMAN TOURING EPS 850 10-14	0430-0563	0430-0563	-
SPORTSMAN TOURING EPS 850 HO 13	0430-0563	0430-0563	-
RANGER 4X4 900 DIESEL CREW 12-14	0430-0563	0430-0563	-
RANGER 900 CREW 14-16	0430-0563	0430-0563	-
RANGER 900 XP 13-16	0430-0563	0430-0563	-
RANGER DIESEL HST/DELUXE 14	0430-0563	0430-0563	-
RZR 4 XP JAGGED X 13	0430-0563	0430-0563	-
900 ACE EFI EPS 17	0430-1020	0430-0563	-
RZR 4 900 15-16	0430-0563	0430-0563	-
RZR 4 XP 900 12-14	0430-0563	0430-0563	-
RZR 900 50 55 INCH 15-16	0430-0563	0430-0563	-
RZR 900 60 INCH 15-16	0430-0563	0430-0563	-
RZR XP 900 11-14	0430-0563	0430-0563	-

FITS MODEL	BALL JOINT LOWER PART #	BALL JOINT UPPER PART #	KING PIN KIT PART #
BALL JOINT & KING PIN KITS (CON'T)			
POLARIS (CON'T)			
SPORTSMAN X2 850 11	0430-0563	0430-0563	-
SPORTSMAN XP 850 09-13	0430-0563	0430-0563	-
SPORTSMAN XP 850 EPS 10-14	0430-0563	0430-0563	-
900 ACE EFI EPS 16	0430-0272	-	-
BRUTUS HD 900 13	0430-0563	0430-0563	-
RANGER 4X4 900 DIESEL 11-14	0430-0563	0430-0563	-
RANGER 1000 DIESEL 15-16	0430-0563	0430-0563	-
RANGER 1000 DIESEL CREW 15-16	0430-0563	0430-0563	-
RANGER 1000 EPS HD MD 19	0430-0457	0430-0563	-
RANGER XP 1000 EPS CREW 19	0430-0457	0430-0563	-
RZR S4 1000 19	0430-0563	0430-0563	-
RZR 1000 60 INCH 19	0430-0563	0430-0563	-
RZR XP 1000 14-19	0430-0739	0430-0739	-
RZR XP 1000 TURBO 16-19	0430-0739	0430-0739	-
RZR XP 4 1000 14-19	0430-0739	0430-0739	-
SCRAMBLER 1000 XP HO EPS 14-19	0430-0563	0430-0563	-
SPORTSMAN 1000 XP 15-19	0430-0563	0430-0563	-
SPORTSMAN TOURING 1000 15-19	0430-0563	0430-0563	-
SUZUKI			
LT-50 84-87	-	-	0430-0252
LT-A50 02-05	-	-	0430-0251
LT-Z50 06-18	-	-	0430-0251
LT-80 87-06	-	-	0430-0251
LT-125 83-87	-	-	0430-0253
LT-160 03-04	-	-	0430-0253
LT-160E 89-92	-	-	0430-0253
LT-F160 91-01	-	-	0430-0253
LT-185 84-87	-	-	0430-0253
LT-230E 87-93	0430-0267	0430-0268	-
LT-230G/E 85-86	0430-0267	0430-0269	-
LT-230S 85-88	0430-0267	0430-0268	-
LT-F230 86-87	0430-0267	0430-0269	-
LT-250EF 85-86	0430-0267	0430-0269	-
LT-250R 85-92	0430-0267	0430-0269	-
LT-250S 89-90	-	0430-0268	-
LT-4WD 250 QUAD RUNNER 87-98	0430-0267	0430-0267	-
LT-F250 2WD 88-01	0430-0267	0430-0267	-
LT-F250 OZARK 02-04	-	0430-0561	-
LT-F250 OZARK 05-14	-	0430-0265	-
LT-F250F 4WD QUAD RUNNER 99-02	0430-0267	0430-0267	-
LT-Z250 04-09	0430-0271	0430-0271	-
LT-300E 87-89	0430-0267	0430-0269	-
LT-F300F KING QUAD 99-02	0430-0267	0430-0267	-
LT-F4WDX KING QUAD 300 91-98	0430-0267	0430-0267	-
LT-A400 2WD KING QUAD 08-09	0430-0270	0430-0270	-
LT-A400 EIGER 2WD 02-07	0430-0270	0430-0270	-
LT-A400F 4WD KING QUAD 08-18	0430-0270	0430-0270	-
LT-A400F EIGER 4WD 02-07	0430-0270	0430-0270	-
LT-F400 2WD KING QUAD 08-18	0430-0270	0430-0270	-
LT-F400 EIGER 2WD 02-07	0430-0270	0430-0270	-
LT-F400F 4WD KING QUAD 08-12	0430-0270	0430-0270	-
LT-F400F EIGER 4WD 02-07	0430-0270	0430-0270	-
LT-Z400 03-04	-	0430-0561	-
LT-Z400 05-14	-	0430-0265	-
LTA-450 X KING QUAD 07-10	0430-0265	0430-0265	-
LT-500R 87-90	0430-0267	0430-0269	-
LT-A500F QUAD MASTER AUTO 00-01	0430-0267	-	-
LT-A500F VINSON 02-07	0430-0270	0430-0270	-
LT-A500X 09-15	0430-0265	0430-0265	-
LT-A500XP 15	0430-0265	0430-0265	-
LT-A500XP POWER STEERING 11-13	0430-0265	0430-0265	-
LT-F500F 98-02	0430-0267	-	-
LT-F500F VINSON 03-07	0430-0270	0430-0270	-
LTA-700 X KING QUAD 05-07	0430-0265	0430-0265	-
LTV-700F TWIN PEAKS 04-06	0430-0308	0430-0562	-
LTA-750 X KING QUAD 08-18	0430-0265	0430-0265	-
LTA-750 XP KING QUAD POWER STEERING 11-18	0430-0265	0430-0265	-
LTA-750X KING QUAD 15-18	0430-0265	0430-0265	-
LTA-750XP KING QUAD 15-18	0430-0265	0430-0265	-
YAMAHA			
YFM50 RAPTOR 04-08	-	-	0430-0248
YFM80 BADGER 92-01	-	-	0430-0248
YFM80 GRIZZLY 05-08	-	-	0430-0248
YFM80 RAPTOR 02-08	-	-	0430-0248

FITS MODEL	BALL JOINT LOWER PART #	BALL JOINT UPPER PART #	KING PIN KIT PART #
BALL JOINT & KING PIN KITS (CON'T)			
YAMAHA (CON'T)			
YFM100 89-91	-	-	0430-0248
YFA1 89-04	-	-	0430-0248
YFM125 GRIZZLY 04-13	-	-	0430-0248
YFM200 MOTO-4 85-89	-	-	0430-0249
YFM225 MOTO-4 86-88	-	-	0430-0249
YFB250 TIMBERWOLF 92-98	-	0430-0562	-
YFB250FW TIMBERWOLF 94-00	-	0430-0562	-
YFM250 BEARTRACKER 99-04	-	0430-0562	-
YFM250 BIG BEAR 07-09	-	0430-0562	-
YFM250 MOTO-4 89-91	-	-	0430-0250
YFM250B BRUIN 05-06	-	0430-0562	-
YFM350 GRIZZLY IRS 07-11	0430-0255	0430-0255	-
YFM350BA BRUIN 2WD 04-06	0430-0255	0430-0255	-
YFM350ER MOTO-4 87-88	-	-	0430-0249
YFM350ER MOTO-4 89-95	-	-	0430-0250
YFM350FA BRUIN 4WD 04-06	0430-0255	0430-0255	-
YFM350FEW GRIZZLY 4WD 07-14	0430-0255	0430-0255	-
YFM350GW GRIZZLY 2WD 07-11	0430-0255	0430-0255	-
YFM35X WOLVERINE 06-09	0430-0255	0430-0255	-
YFP350U TERRA PRO 88	-	-	0430-0250
YFM400 BIG BEAR 2WD 00-04	0430-0255	0430-0255	-
YFM400 BIG BEAR 4WD 00-06	0430-0255	0430-0255	-
YFM400 BIG BEAR IRS 07-12	0430-0255	0430-0255	-
YFM400 GRIZZLY IRS 07-08	0430-0255	0430-0255	-
YFM400 KODIAK 2WD 03-04	0430-0255	0430-0255	-
YFM400 KODIAK 4WD 03-06	0430-0255	0430-0255	-
450 RHINO 06-09	0430-0255	0430-0255	-
YFM450 GRIZZLY EPS 11-14	0430-0255	0430-0255	-
YFM450 GRIZZLY IRS 07-14	0430-0255	0430-0255	-
YFM450 KODIAK 03-06	0430-0255	0430-0255	-
KODIAK 450 4WD 18-19	0430-0604	0430-0604	-
KODIAK 450 EPS 4WD 18-19	0430-0604	0430-0604	-
YFM450FX WOLVERINE 450 4X4 06-10	0430-0255	0430-0255	-
YFZ450 04-13	0430-0271	-	-
YFZ450R 09-19	0430-0271	0430-0271	-
YFZ450X 10-11	0430-0271	0430-0271	-
YFM550 GRIZZLY 09-12	0430-0604	0430-0271	-
YFM550 GRIZZLY 13-14	0430-0604	0430-0604	-
YFM550 GRIZZLY EPS 09-12	0430-0604	0430-0271	-
YFM550 GRIZZLY EPS 13-14	0430-0604	0430-0604	-
YFM600 GRIZZLY 98-01	-	0430-0562	-
660 RHINO 04-07	0430-0255	0430-0255	-
YFM660 GRIZZLY 02-08	0430-0309	-	-
YFM660R RAPTOR 01-05	0430-0271	-	-
700 PROHAULER 04-06	-	-	0430-0250
700 RHINO FI 08-13	0430-0255	0430-0255	-
KODIAK 700 4WD 16-18	0430-0604	0430-0604	-
KODIAK 700 EPS 4WD 16-18	0430-0604	0430-0604	-
VIKING 700 14-18	0430-0864	0430-0864	-
VIKING 700 VI 15-18	0430-0864	0430-0864	-
WOLVERINE R-SPEC EPS 16-18	0430-0864	0430-0864	-
YFM700 GRIZZLY 07-12	0430-0604	0430-0271	-
YFM700 GRIZZLY 13-17	0430-0604	0430-0604	-
YFM700 GRIZZLY EPS 08-12	0430-0604	0430-0271	-
YFM700 GRIZZLY EPS 13-19	0430-0604	0430-0604	-
YFM700R RAPTOR 06-13	0430-0271	-	-
YFM700R RAPTOR 14-17	0430-0271	0430-0271	-
YXZ1000R 16-19	0430-0940	0430-0940	-
1000 PROHAULER 04-05	-	-	0430-0250
WOLVERINE X2 19	0430-0864	0430-0864	-
WOLVERINE X2 R-SPEC 19	0430-0864	0430-0864	-
WOLVERINE X4, X4 SE, X4 HUNTER 18-19	0430-0864	0430-0864	-



- PLOWS
- WINCHES
- UTV
- RACKS
- IMPLEMENTS & TOWING
- LUGGAGE
- BODY
- CONTROLS
- ELECTRICAL
- WHEELS & TIRES
- SUSPENSION & DRIVE
- BRAKING
- ENGINE
- RIDER
- GARAGE
- PROMO

SUSPENSION & DRIVE



CV HALFSHAFTS

Heavy-duty fully assembled outboard joint and boot assembly. Includes axle bar, inboard puncture resistant boot, clamps and grease. Polaris halfshafts include axle bar, inboard universal joint and yoke assembly. Made in the USA.

FITS MODEL	LEFT HAND AXLE PART #	RIGHT HAND AXLE PART #
CV HALFSHAFTS		
ARCTIC CAT-FRONTS		
250 01 4X4-18 TEETH ON BAR	-	0214-0269
300 98-00 4X4	-	0214-0269
300 01 4X4-18 TEETH ON BAR	-	0214-0269
400 98-00 4X4	0214-0269	0214-0269
400 01 4X4-18 TEETH ON BAR	-	0214-0269
400 02-04 4X4-W/ FIS	0214-0267	0214-0267
400 05 4X4-EXC. VALUE PACKAGE	0214-0268	0214-0268
400 06 4X4-EXC. VALUE PACKAGE	0214-0347	0214-0347
400 07-08 4X4	0214-0347	0214-0347
454 98 4X4-FROM #13001	0214-0269	0214-0269
500 98-99 4X4	0214-0269	0214-0269
500 00 4X4	-	0214-0269
500 01 4X4-18 TEETH ON BAR	-	0214-0269
500 02 4X4-W/ FIS	0214-0267	0214-0267
500 03-04 4X4	0214-0267	0214-0267
500 05 4X4	0214-0268	0214-0268
500 06-08 4X4	0214-0347	0214-0347
650 04 4X4	0214-0267	0214-0267
650 05 4X4	0214-0268	0214-0268
650 06-08 4X4-EXC. PROWLER XT	0214-0347	0214-0347
700 07-08 4X4	0214-0347	0214-0347
CAN-AM-FRONTS		
OUTLANDER 330 04-05 4X4	0214-0534	0214-0534
OUTLANDER 400 03-05 4X4	0214-0534	0214-0534
QUEST 500 02-04 4X4	0214-0608	0214-0608
TRAXTER 500 01 4X4-7459/7460/7467/7468/7472/7481	0214-0608	0214-0608
TRAXTER 500 01 4X4-AUTOSHIFT-EXC. 7431/7432	0214-0608	0214-0608
TRAXTER 500 01 4X4-FOOTSHIFT 7473/7474	0214-0608	0214-0608
TRAXTER 500 01 4X4-XL 7448-FROM SERIAL NO. V000709	0214-0608	0214-0608
TRAXTER 500 01 4X4-XL 7467/7468/7472/7481/7489	0214-0608	0214-0608
TRAXTER 500 02-05 4X4	0214-0608	0214-0608
QUEST 650 02-04 4X4	0214-0608	0214-0608
HONDA-FRONTS		
TRX300 FOURTRAX 88-92 4X4	0214-0105	0214-0105
TRX300 FOURTRAX 93-00 4X4	0214-0151	0214-0151
TRX350 RANCHER 00-05 4X4	0214-0152	0214-0152
TRX400 FOREMAN 95-01 4X4	-	0214-0105
TRX500 FOREMAN 05-06 4X4	0214-0397	-
TRX500 FOREMAN 07 4X4-EXC. ES W/ POWER STEERING	0214-0397	-
TRX500 RUBICON 05-07 4X4	0214-0397	-
TRX680 RINCON 05-07 4X4	0214-0397	-
JOHN DEERE-FRONTS		
BUCK 04-06 4X4	0214-0608	0214-0608
KAWASAKI-FRONTS		
PRAIRIE 300 99-02 4X4	0214-0405	0214-0405
MULE 2510 93-99 4WD-620CC	0214-0406	0214-0406
MULE 2510 00-02 4WD-620CC & 950CC DIESEL	0214-0345	0214-0345
MULE 3010 01-08 4WD-620CC & 950CC DIESEL	0214-0345	0214-0345
MULE 4010 09-12 4WD-620CC & 950CC DIESEL	0214-0508	0214-0508
SUZUKI-FRONTS		
QUADRUNNER 250 88-96 4X4	0214-0400	0214-0400
QUADRUNNER 250 97-98 4X4-W/ 68LAC IB	0214-0275	0214-0399
QUADRUNNER 250 97-98 4X4-W/ 71LAC IB	0214-0400	0214-0400
QUADRUNNER 250 99-02 4X4	0214-0399	0214-0399
KING QUAD 300 91-93 4X4	0214-0402	0214-0402
QUADRUNNER 300 94-95 4X4	0214-0402	0214-0402
KING QUAD 300 96-98 4X4-W/ 68LAC IB	0214-0275	0214-0275
KING QUAD 300 96-98 4X4-W/ 71LAC IB	0214-0402	0214-0402
KING QUAD 300 99-02 4X4	0214-0275	0214-0275
EIGER 400 02 4X4	0214-0401	-
EIGER 400 03-04 4X4-W/ 68LAC OB	0214-0401	-
QUADMASTER 500 00 4X4	0214-0275	0214-0275
QUADMASTER 500 01 4X4	0214-0401	0214-0401
QUADRUNNER 500 98-00 4X4	0214-0275	0214-0275
QUADRUNNER 500 01-02 4X4	0214-0401	0214-0401
TIMBERWOLF 250 94-00 4X4	0214-0102	0214-0102
WOLVERINE 350 95-00 4X4	0214-0103	0214-0103
BIG BEAR 350 89-96 4X4	0214-0102	0214-0102
BIG BEAR 350 97 4X4-W/ 68LAC IB	0214-0102	0214-0102

FITS MODEL	LEFT HAND AXLE PART #	RIGHT HAND AXLE PART #
CV HALFSHAFTS (CON'T)		
YAMAHA-FRONTS		
BIG BEAR 350 97 4X4-W/ 68LAC IB	0214-0103	0214-0103
BIG BEAR 350 98-99 4X4	0214-0103	0214-0103
BRUIN 350 04-06 4X4	0214-0192	0214-0192
GRIZZLY 350 07-08 4X4-EXC. IRS	0214-0192	0214-0192
BIG BEAR 400 00-01 4X4-EXC. IRS	0214-0103	0214-0103
GRIZZLY 400 07 4X4	0214-0192	0214-0192
KODIAK 400 93-98 4X4	0214-0102	0214-0102
KODIAK 400 99 4X4	0214-0103	0214-0103
KODIAK 400 00-02 4X4	0214-0349	0214-0349
KODIAK 400 03-06 4X4	0214-0192	0214-0192
WOLVERINE 450 SPORT 06-08 4X4	0214-0192	0214-0192
GRIZZLY 550 09-14	0214-0536	0214-0536
GRIZZLY 660 02 4X4	0214-0154	0214-0154
GRIZZLY 700 07-13 4X4	0214-0536	0214-0536
ARCTIC CAT-REARS		
400 02-04 2X4/4X4	0214-0267	0214-0267
400 05 4X4	0214-0268	0214-0268
400 06-08 4X4	0214-0347	0214-0347
500 03-04 4X4	0214-0267	0214-0267
500 05 4X4	0214-0268	0214-0268
500 06-08 4X4	0214-0347	0214-0347
650 05 4X4	0214-0268	0214-0268
650 06-08 4X4-EXC. PROWLER XT	0214-0347	0214-0347
650 06-08 4X4-PROWLER XT	0214-0346	0214-0346
700 07-08 4X4	0214-0347	0214-0347
KAWASAKI-REARS		
BRUTE FORCE 650I 06-08 4X4	0214-0193	0214-0193
BRUTE FORCE 750I 05-07 4X4	0214-0193	0214-0193
POLARIS-REARS		
SPORTSMAN 335 00 4X4	0214-0272	0214-0272
SPORTSMAN 400 01-02 4X4	0214-0272	0214-0272
SPORTSMAN 400 03-05 4X4	0214-0273	0214-0273
SPORTSMAN 500 99-02 4X4	0214-0272	0214-0272
SPORTSMAN 500 03-05 4X4	0214-0273	0214-0273
SPORTSMAN 600 03-05 4X4	0214-0273	0214-0273
SPORTSMAN 700 03-05 4X4	0214-0273	0214-0273
SPORTSMAN 800 05 4X4	0214-0273	0214-0273
RZR S "SPORT" 09-10 4X4	0214-0713	0214-0713
SUZUKI-REARS		
KING QUAD 450 4X4 07-10	0214-0808	0214-0808
KING QUAD 500 4X4-EXC. POWER STEERING 11-12	0214-0808	0214-0808
KING QUAD 700 4X4-INBOARD CV WITH 26 TOOTH INNER RACE 07	0214-0808	0214-0808
KING QUAD 750 4X4 08-12	0214-0808	0214-0808
YAMAHA-REARS		
GRIZZLY 550 09-13	0214-0537	0214-0537
GRIZZLY 660 02 4X4	-	0214-0276
GRIZZLY 660 03-05 4X4	0214-0156	-
GRIZZLY 700 07-13 4X4	0214-0537	0214-0537





COMPLETE AXLE ASSEMBLIES

Fully assembled outboard CV Joint. Heavy-duty puncture resistant boot and axle bar. Some models come with a universal joint & yoke assembly or a fully assembled inboard CV joint. Made in the USA.

FITS MODEL	LEFT AXLE PART #	RIGHT AXLE PART #
COMPLETE AXLE ASSEMBLIES		
ARCTIC CAT-FRONTS		
250 4X4 02-04	0214-0697	0214-0697
375 4X4 02	0214-0697	0214-0697
300 4X4 02-04	0214-0697	0214-0697
400 4X4-FIS 07-08	0214-0702	-
400 4X4-FIS-06	0214-0702	-
400 4X4-EXC. FIS 02-04	0214-0697	0214-0697
400 4X4-W/ FIS-02-04	0214-0617	0214-0617
500 4X4 07-08	0214-0702	-
500 4X4-FIS 06	0214-0702	-
500 4X4-TBX-06	0214-0702	-
500 4X4-03-04	0214-0617	0214-0617
500 4X4-TBX-02	0214-0697	0214-0697
500 4X4-W/ FIS-02	0214-0617	0214-0617
650 4X4-EXC. PROWLER XT-06-08	0214-0702	-
650 4X4-04	-	0214-0617
700 4X4-07-08	0214-0702	-
HONDA-FRONTS		
TRX350 RANCHER 4X4 06	0214-0680	0214-0680
TRX450 FOREMAN 4X4 98-04	0214-0678	0214-0679
TRX500 FOREMAN 4X4-EXC. ES W/ PWR STEERING 07	0214-0681	0214-0682
TRX500 FOREMAN 4X4 05-06	0214-0681	0214-0682
TRX500 RUBICON 4X4 05-07	0214-0681	0214-0682
TRX500 RUBICON 4X4 01-04	0214-0611	0214-0612
TRX650 RINCON 4X4 05	0214-0681	0214-0682
TRX680 RINCON 4X4 06-07	0214-0681	0214-0682
TRX680 RINCON 4X4 190-15	0214-0681	0214-0682
KAWASAKI-FRONTS		
BAYOU 300 4X4 89-04	0214-0904	0214-0904
BAYOU 400 4X4 93-99	0214-0904	0214-0904
BRUTE FORCE 650I 4X4 06-13	0214-0522	0214-0523
BRUTE FORCE 750I 4X4 05-07	0214-0522	0214-0523
BRUTE FORCE 750I 4X4 12-16	0214-0522	0214-0523
MULE 610 4WD-400CC 05-16	0214-0521	0214-0521
MULE 2510 4WD-620CC & 950CC DIESEL 00-02	0214-0519	0214-0519
MULE 3010 4WD-620CC & 950CC DIESEL 01-08	0214-0519	0214-0519
MULE 4010 4WD-620CC & 950CC DIESEL 09-16	0214-0519	0214-0519
TERYX 750 4X4 08-11	0214-0618	0214-0618
TERYX 750 4X4-EXC. TERYX4 12	0214-0618	0214-0618
POLARIS-FRONTS		
XPLORER 250 4X4 00-02	0214-0279	0214-0279
HAWKEYE 300 4X4-06-07	0214-0689	0214-0689
SPORTSMAN 300 4X4 08-10	0214-0689	0214-0689
XPLORER 300 4X4 98-99	0214-0101	0214-0101
XPLORER 300 4X4-FROM 1/1/97 97	0214-0101	0214-0101
MAGNUM 325 4X4-EXC. HDS (VISCO-LOK) 01-02	0214-0101	0214-0101
MAGNUM 325 4X4 00	0214-0101	0214-0101
XPEDITION 325 4X4 00-02	0214-0101	0214-0101
MAGNUM 330 4X4-EXC. HDS (VISCO-LOK) 04	0214-0278	0214-0278
MAGNUM 330 4X4-EXC. HDS (VISCO-LOK) 03	0214-0278	0214-0278
ATP 330 4X4 04	0214-0278	0214-0278
SPORTSMAN 335 4X4 99-00	0214-0101	0214-0101
BIG BOSS 400L 6X6-FROM 1/1/97 97	0214-0101	0214-0101
SCRAMBLER 400 4X4 00-02	0214-0279	0214-0279
SCRAMBLER 400 4X4-W/ BTB 0B 99	0214-0101	0214-0101
SCRAMBLER 400 4X4-W/ USA 0B 99	0214-0279	0214-0279
SCRAMBLER 400 4X4 98	0214-0101	0214-0101
SPORTSMAN 400 4X4 13-14	0214-0919	0214-0919
SPORTSMAN 400 4X4 11-12	0214-0926	0214-0926
SPORTSMAN 400 4X4 08-10	0214-0689	0214-0689
SPORTSMAN 400 4X4 05	0214-0386	0214-0386
SPORTSMAN 400 4X4-W/ FEMALE SPLINE ON IB YOKE 04	0214-0279	0214-0279
SPORTSMAN 400 4X4-W/ MALE SPLINE ON IB YOKE-04	0214-0278	0214-0278
SPORTSMAN 400 4X4 02-03	0214-0279	0214-0279
SPORTSMAN 400 4X4 01	0214-0101	0214-0101
SPORTSMAN 400 4X4 97	0214-0101	0214-0101
XPLORER 400 4X4 99-02	0214-0279	0214-0279
XPLORER 400 4X4 98	0214-0101	0214-0101
XPLORER 400 4X4-FROM 1/1/97 97	0214-0101	0214-0101

FITS MODEL

COMPLETE AXLE ASSEMBLIES (CON'T)

POLARIS-FRONTS (CON'T)

	LEFT AXLE PART #	RIGHT AXLE PART #
MAGNUM 425 4X4 98	0214-0101	0214-0101
MAGNUM 425 4X4-FROM 1/1/97 97	0214-0101	0214-0101
MAGNUM 425 6X6-FROM 1/1/97 97	0214-0101	0214-0101
XPEDITION 425 4X4 02	0214-0279	0214-0279
XPEDITION 425 4X4 00-01	0214-0101	0214-0101
SPORTSMAN 450 4X4-AFTER 7/25/06 07	0214-0616	0214-0616
SPORTSMAN 450 4X4 06	0214-0386	0214-0386
MAGNUM 500 2X4-HDS (VISCO-LOK) 02	0214-0279	0214-0279
MAGNUM 500 4X4-EXC. HDS (VISCO-LOK) 02	0214-0383	0214-0383
MAGNUM 500 4X4-EXC. HDS (VISCO-LOK) 01	0214-0101	0214-0101
MAGNUM 500 4X4 99-00	0214-0101	0214-0101
DIESEL 4X4 99-02	0214-0101	0214-0101
ATP 500 H.O. 4X4 04	0214-0278	0214-0278
BIG BOSS 500 6X6 98-99	0214-0101	0214-0101
SCRAMBLER 500 4X4 99-09	0214-0279	0214-0279
SCRAMBLER 500 4X4 98	0214-0101	0214-0101
SCRAMBLER 500 4X4-FROM 1/1/97 97	0214-0101	0214-0101
SPORTSMAN 500 4X4 13-14	0214-0919	0214-0919
SPORTSMAN 500 4X4 11-12	0214-0926	0214-0926
SPORTSMAN 500 4X4 09-10	0214-0616	0214-0616
SPORTSMAN 500 4X4 08	0214-0616	0214-0616
SPORTSMAN 500 6X6 08	0214-0279	0214-0279
SPORTSMAN 500 4X4-AFTER 7/25/06 07	0214-0616	0214-0616
SPORTSMAN 500 6X6 07	0214-0279	0214-0279
SPORTSMAN 500 4X4 05-06	0214-0386	0214-0386
SPORTSMAN 500 6X6 05-06	0214-0279	0214-0279
SPORTSMAN 500 4X4-W/ FEMALE SPLINE ON IB YOKE 04	0214-0279	0214-0279
SPORTSMAN 500 4X4-W/ MALE SPLINE ON IB YOKE 04	0214-0278	0214-0278
SPORTSMAN 500 6X6 04	0214-0279	0214-0279
SPORTSMAN 500 4X4 02-03	0214-0279	0214-0279
SPORTSMAN 500 6X6 02-03	0214-0279	0214-0279
SPORTSMAN 500 4X4 00-01	0214-0101	0214-0101
SPORTSMAN 500 6X6 00-01	0214-0101	0214-0101
SPORTSMAN 500 4X4 98-99	0214-0101	0214-0101
SPORTSMAN 500 4X4 97	0214-0279	0214-0279
XPLORER 500 4X4 97	0214-0279	0214-0279
SPORTSMAN 550 4X4 11-14	0214-0925	0214-0925
SPORTSMAN 570 4X4 14	0214-0919	0214-0919
SPORTSMAN 600 4X4 05	0214-0386	0214-0386
SPORTSMAN 600 4X4 03-04	0214-0278	0214-0278
SPORTSMAN 700 4X4 08	0214-0616	0214-0616
SPORTSMAN 700 4X4-AFTER 7/25/06 07	0214-0616	0214-0616
SPORTSMAN 700 4X4 05-06	0214-0386	0214-0386
SPORTSMAN 700 4X4 03-04	0214-0278	0214-0278
SPORTSMAN 700 4X4-FROM 5/1/02-02	0214-0278	0214-0278
SPORTSMAN 700 4X4-T0 5/1/02-02	0214-0383	0214-0383
SPORTSMAN 800 4X4 13-14	0214-0919	0214-0919
SPORTSMAN 800 6X6 13-14	0214-0919	0214-0919
SPORTSMAN 800 4X4 11-12	0214-0926	0214-0926
SPORTSMAN 800 6X6 11-12	0214-0926	0214-0926
SPORTSMAN 800 4X4 08-10	0214-0616	0214-0616
SPORTSMAN 800 6X6 08-10	0214-0616	0214-0616
SPORTSMAN 800 4X4-AFTER 7/25/06 07	0214-0616	0214-0616
SPORTSMAN 800 4X4 05-06	0214-0386	0214-0386
SPORTSMAN 850 4X4 11-14	0214-0925	0214-0925
SPORTSMAN 850 16-17 4X4	0214-1210	0214-1210
SCRAMBLER 850 4X4 13-14	0214-0925	0214-0925
SCRAMBLER 1000 4X4 14	0214-0925	0214-0925
SPORTSMAN 1000 16-17 4X4-XP	0214-1210	0214-1210
SCRAMBLER 1000 14-17 4X4	0214-0925	0214-0925
SCRAMBLER 850 13-17 4X4	0214-0925	0214-0925
SPORTSMAN 1000 15 4X4-XP	0214-0925	0214-0925
SPORTSMAN 1000 16-17 4X4-XP	0214-1210	0214-1210
SPORTSMAN 450 16 4X4	0214-0919	0214-0919
SPORTSMAN 570 14-16 4X4	0214-0919	0214-0919
SPORTSMAN 800 15 6X6	0214-0919	0214-0919
SPORTSMAN 850 11-15 4X4	0214-0925	0214-0925
SPORTSMAN 850 16-17 4X4	0214-1210	0214-1210
SPORTSMAN ETX 15 4X4	0214-0919	0214-0919
RANGER 400 4X4-10-14	0214-0693	0214-0693
RANGER 4X4-SERIES 11 03-04	0214-0336	0214-0336
RANGER 500 4X4-W/ CV JOINT AT INBOARD END 04-05	0214-0516	0214-0516
RANGER 500 4X4-W/ U-JOINT AT INBOARD END 04-05	0214-0336	0214-0336
RANGER 500 4X4 06-07	0214-0516	0214-0516
RANGER 500 4X4 08	0214-0614	0214-0614

PLOWS
WINCHES
UTV
RACKS
IMPLEMENT & TOWING
LUGGAGE
BODY
CONTROLS
ELECTRICAL
WHEELS & TIRES
SUSPENSION & DRIVE
BRAKING
ENGINE
RIDER
GARAGE
PROMO

SUSPENSION & DRIVE

FITS MODEL	LEFT AXLE PART #	RIGHT AXLE PART #
COMPLETE AXLE ASSEMBLIES (CON'T)		
POLARIS-FRONTS (CON'T)		
RANGER 500 4X4 09-10	0214-0691	0214-0691
RANGER 500 4X4 11-13	0214-0693	0214-0693
RANGER 500 6X6 04-05	0214-0336	0214-0336
RANGER 570 15 4X4-FULL-SIZE W/137 CM (54") WIDE BED BOX	0214-0692	0214-0692
RANGER 570 15 4X4-MID-SIZE W/107 CM (42") WIDE BED BOX	0214-1209	0214-1209
RANGER 570 16 4X4-EXC. XP-FULL-SIZE W/137 CM (54") WIDE BED BOX	0214-1203	0214-1203
RANGER 570 16 4X4-EXC. XP-MID-SIZE W/107 CM (42") WIDE BED BOX	0214-1209	0214-1209
RANGER 570 16 4X4-XP	0214-0692	0214-0692
RANGER 570 4X4 14	0214-0693	0214-0693
RANGER 6X6-SERIES 10 02	0214-0336	0214-0336
RANGER 6X6-SERIES 11 03-04	0214-0336	0214-0336
RANGER 6X6-SERIES 99 99-01	0214-0385	0214-0385
RANGER 700 4X4-EFI CREW 08-09	0214-0614	0214-0614
RANGER 700 4X4-XP 05-07	0214-0516	0214-0516
RANGER 700 4X4-XP 08	0214-0614	0214-0614
RANGER 700 4X4-XP 09	0214-0691	0214-0691
RANGER 700 6X6 06-07	0214-0516	0214-0516
RANGER 700 6X6-08	0214-0614	0214-0614
RANGER 700 6X6 09	0214-0614	0214-0614
RANGER 800 15-16 6X6	0214-0913	0214-0913
RANGER 800 4X4-FULL-SIZE W/137 CM (54") WIDE BED BOX 14	0214-0913	0214-0913
RANGER 800 4X4-MID-SIZE W/107 CM (42") WIDE BED BOX 14	0214-0693	0214-0693
RANGER 800 4X4 10	0214-0691	0214-0691
RANGER 800 4X4 11-14	0214-0913	0214-0913
RANGER 800 6X6 10	0214-0691	0214-0691
RANGER 800 6X6 11-13	0214-0913	0214-0913
RANGER 800 6X6 14	0214-0913	0214-0913
RANGER 900 13-16 4X4	0214-0692	0214-0692
RANGER ETX 15-16 4X4	0214-1209	0214-1209
RANGER ETX 15-16 4X4	0214-1209	0214-1209
RANGER EV-ELECTRIC VEHICLE 15-16 4X4	0214-1209	0214-1209
RANGER EV-ELECTRIC VEHICLE 15-16 4X4	0214-1209	0214-1209
GENERAL 1000 16 4X4	0214-1205	0214-1205
RANGER 1000 15-16 4X4-DIESEL	0214-0692	0214-0692
RANGER 1000-DIESEL 15-16	0214-0692	0214-0692
RZR 570 12-16 4X4	0214-0517	0214-0517
RZR 570 4X4 12-16	0214-0517	0214-0517
RZR 800 4X4-4 SEATER 11-14	0214-0692	0214-0692
RZR 800 4X4-EXC. S SERIES & 4 SEATER 09-14	0214-0517	0214-0517
RZR 800 4X4-S SERIES-09-14	0214-0692	0214-0692
RZR 800 4X4 08	0214-0517	0214-0517
RZR 900 15-16 4X4-4 SEATER	0214-1205	0214-1205
RZR 900 15-16 4X4-EXC. S SERIES & 4 SEATER	0214-0517	0214-0517
RZR 900 15-16 4X4-S SERIES	0214-1205	0214-1205
RZR 1000 14-15 4X4	0214-0927	0214-0927
RZR 1000 16 4X4-XP NON-TURBO (2 SEATER)	0214-0927	0214-0927
RZR 1000 16 4X4-XP NON-TURBO (4 SEATER) 10/19/15 AND BEFORE	0214-0927	0214-0927
RZR 1000 16 4X4-S SERIES	0214-1205	0214-1205
RZR 1000 16 4X4-S SERIES	0214-1205	0214-1205
RZR 1000 16 4X4-XP NON-TURBO (4 SEATER) 10/20/15 AND AFTER	0214-1207	0214-1207
RZR 1000 16 4X4-XP TURBO	0214-1208	0214-1208
POLARIS-MIDDLES		
SPORTSMAN 800 (MIDDLE AXLES) 6X6 11-14	0214-0920	0214-0920
SPORTSMAN 800 (MIDDLE AXLES) 6X6 09-10	0214-0626	0214-0626
RANGER 800 (MIDDLE AXLES) 6X6 10	0214-0627	0214-0627
RANGER 700 (MIDDLE AXLES) 6X6 09	0214-0627	0214-0627
YAMAHA-FRONTS		
TIMBERWOLF 250 4X4 94-00	0214-0510	0214-0510
BIG BEAR 350 4X4 89-96	0214-0510	0214-0510
BIG BEAR 350 4X4-W/ 68AC IB 97	0214-0510	0214-0510
BIG BEAR 350 4X4-W/ 68LAC IB 97	0214-0511	0214-0511
BIG BEAR 350 4X4 98-99	0214-0511	0214-0511
BRUIN 350 4X4 04-06	0214-0512	0214-0512
GRIZZLY 350 4X4-EXC. IRS 07-11	0214-0512	0214-0512
GRIZZLY 350 4X4-W/ IRS 07-11	0214-0797	-
WOLVERINE 350 4X4 95-00	0214-0511	0214-0511
BIG BEAR 400 4X4 00-01	0214-0511	0214-0511
BIG BEAR 400 4X4 02-06	0214-0677	0214-0677
BIG BEAR 400 4X4-07-11	0214-0797	-
BIG BEAR 400 4X4 12	0214-0797	-
KODIAK 400 4X4 93-98	0214-0510	0214-0510
KODIAK 400 4X4 99	0214-0511	0214-0511
KODIAK 400 4X4 03-06	0214-0512	0214-0512
GRIZZLY 400 4X4 07	0214-0512	0214-0512
GRIZZLY 450 4X4 07	-	0214-0898

FITS MODEL	LEFT AXLE PART #	RIGHT AXLE PART #
COMPLETE AXLE ASSEMBLIES (CON'T)		
YAMAHA-FRONTS (CON'T)		
GRIZZLY 450 4X4 08-11	0214-0797	-
GRIZZLY 450 4X4 12-14	-	0214-0797
KODIAK 450 4X4 03-06	-	0214-0898
WOLVERINE 450 4X4 06-10	0214-0512	0214-0512
GRIZZLY 550 4X4 09-13	0214-0513	0214-0513
GRIZZLY 600 4X4 99-01	0214-0609	0214-0609
GRIZZLY 660 4X4 03-08	0214-0339	0214-0282
GRIZZLY 700 4X4 07-13	0214-0513	0214-0513
YAMAHA UTV-FRONTS		
RHINO 450 4X4 06-09	0214-0341	0214-0342
RHINO 660 4X4 06-07	0214-0341	0214-0342
RHINO 700 4X4 08-13	0214-0610	0214-0610
ARCTIC CAT-REARS		
400 2X4/4X4 02-04	0214-0617	0214-0617
400 4X4 05	0214-0698	0214-0698
400 4X4 06-08	0214-0700	0214-0700
500 4X4 03-04	0214-0617	0214-0617
500 4X4 05	0214-0698	0214-0698
500 4X4 06-08	0214-0700	0214-0700
650 4X4 04-05	0214-0698	0214-0698
650 4X4 06-08	0214-0700	0214-0700
700 4X4 07-08	0214-0700	0214-0700
650 4X4 PROWLER XT 06-08	0214-0699	0214-0699
PROWLER 700 15	0214-0699	0214-0699
KAWASAKI-REARS		
BRUTE FORCE 650I 4X4 06-13	0214-0520	0214-0520
BRUTE FORCE 750I 4X4 05-16	0214-0520	0214-0520
POLARIS-REARS		
HAWKEYE 300 2X4/4X4 06-11	0214-0613	0214-0613
SPORTSMAN 300 4X4 08-10	0214-0613	0214-0613
HAWKEYE 325 15 2X4	0214-0921	0214-0921
SPORTSMAN 335 4X4 00	0214-0283	0214-0283
HAWKEYE 400 2X4 11-14	0214-0920	0214-0920
SPORTSMAN 400 4X4 01-02	0214-0283	0214-0283
SPORTSMAN 400 4X4 03-05	0214-0286	0214-0286
SPORTSMAN 400 4X4 08-10	0214-0613	0214-0613
SPORTSMAN 400 4X4 11-14	0214-0920	0214-0920
SPORTSMAN 450 4X4 06-07	0214-0286	0214-0286
SPORTSMAN 500 4X4 99-02	0214-0283	0214-0283
SPORTSMAN 500 4X4 03-05	0214-0286	0214-0286
SPORTSMAN 500 4X4-EXC. X2 06-07	0214-0286	0214-0286
SPORTSMAN 500 4X4-EXC. TOURING & X2 08-10	0214-0626	0214-0626
SPORTSMAN 500 4X4-EXC. TOURING 11-13	0214-0920	0214-0920
SPORTSMAN 500 4X4-TOURING 11-13	0214-0921	0214-0921
SPORTSMAN 500 4X4 14	0214-0920	0214-0920
SPORTSMAN 550 4X4-TOURING 10	0214-0903	0214-0903
SPORTSMAN 550 4X4-EXC. TOURING & X2-FROM 11/17/09 10	0214-0903	0214-0903
SPORTSMAN 550 4X4-EXC. TOURING & X2-TO 11/16/09 10	0214-0629	0214-0629
SPORTSMAN 550 4X4 11-14	0214-0903	0214-0903
SPORTSMAN 570 4X4 14	0214-0920	0214-0920
SPORTSMAN 600 4X4 03-05	0214-0286	0214-0286
SPORTSMAN 700 4X4 02	0214-0685	0214-0685
SPORTSMAN 700 4X4 03-07	0214-0286	0214-0286
SPORTSMAN 800 4X4 05-06	0214-0286	0214-0286
SPORTSMAN 800 4X4-EXC. X2 07	0214-0286	0214-0286
SPORTSMAN 800 4X4-EXC. TOURING & X2 08-10	0214-0626	0214-0626
SPORTSMAN 800 4X4-TOURING 08-10	0214-0622	0214-0622
SPORTSMAN 800 4X4 11-14	0214-0920	0214-0920
SPORTSMAN 800 6X6 11-14	0214-0920	0214-0920
SPORTSMAN 850 4X4-EXC. TOURING 10	0214-0629	0214-0629
SPORTSMAN 850 4X4 11-14	0214-0903	0214-0903
SCRAMBLER 850 4X4 13-14	0214-0903	0214-0903
SCRAMBLER 1000 14-17 4X4	0214-0903	0214-0903
SCRAMBLER 850 13-17 4X4	0214-0903	0214-0903
SPORTSMAN 1000 15-17 4X4-XP	0214-0903	0214-0903
SPORTSMAN 450 16 4X4	0214-0921	0214-0921
SPORTSMAN 570 15-16 4X4	0214-0921	0214-0921
SPORTSMAN 800 15 6X6	0214-0920	0214-0920
SPORTSMAN 850 11-17 4X4	0214-0903	0214-0903
SPORTSMAN ACE 570 15-16 4X4	0214-0923	0214-0923
SPORTSMAN ACE 900 16 4X4	0214-0923	0214-0923
SPORTSMAN ETX 15 4X4	0214-0921	0214-0921
RANGER 500 4X4 10	0214-0630	0214-0630
RANGER 570 15 4X4-FULL-SIZE W/137 CM (54") WIDE BED BOX	0214-0918	0214-0918
RANGER 570 15 4X4-MID-SIZE W/107 CM (42") WIDE BED BOX	0214-0929	0214-0929

FITS MODEL	LEFT AXLE PART #	RIGHT AXLE PART #
COMPLETE AXLE ASSEMBLIES (CON'T)		
POLARIS-REARS (CON'T)		
RANGER 570 16 4X4-EXC. XP	0214-0929	0214-0929
RANGER 570 16 4X4-XP	0214-0918	0214-0918
RANGER 570 4X4 14	0214-0929	0214-0929
RANGER 700 4X4 05-07	0214-0686	-
RANGER 700 4X4 09	0214-0694	-
RANGER 800 4X4 10	0214-0630	0214-0630
RANGER 800 6X6 10	0214-0694	-
RANGER 800 4X4 11-13	0214-0909	0214-0909
RANGER 800 6X6 11-13	-	0214-0915
RANGER 800 4X4-FULL-SIZE W/137 CM (54") WIDE BED BOX 14	0214-0909	0214-0909
RANGER 800 6X6 14	-	0214-0915
RANGER 900 4X4 11-12	0214-0916	0214-0917
RANGER 900 4X4-DIESEL 13-16	0214-0916	0214-0917
RANGER 900 4X4-EXC DIESEL 13-16	0214-0918	0214-0918
RANGER 1000 15 4X4-DIESEL EXC. HST	0214-0918	0214-0918
RANGER 1000 15 4X4-DIESEL HST	0214-0922	0214-0922
RANGER 1000 16 4X4-DIESEL	0214-0918	0214-0918
RANGER 800 15-16 6X6	-	0214-0915
RANGER 900 15-16 4X4	0214-0918	0214-0918
RANGER ETX 15-16 4X4	0214-0929	0214-0929
RANGER GENERAL 1000 16 4X4	0214-1206	0214-1206
RZR 570 12-16 4X4	0214-0923	0214-0923
RZR 570 4X4 12-14	0214-0923	0214-0923
RZR 800 4X4 08	0214-0518	0214-0518
RZR 800 4X4-4 SEATER 11-14	0214-0911	0214-0911
RZR 800 4X4-4 SEATER INTL. 11-12	0214-0911	0214-0911
RZR 800 4X4-EXC. S SERIES 09-10	0214-0518	0214-0518
RZR 800 4X4-S SERIES 11-14	0214-0911	0214-0911
RZR 800 4X4-S SERIES INTL. 11-12	0214-0911	-
RZR 900 15-16 4X4-4 SEATER	0214-1206	0214-1206
RZR 900 15-16 4X4-EXC. S SERIES & 4 SEATER	0214-1204	0214-1204
RZR 900 15-16 4X4-S SERIES	0214-1206	0214-1206
RZR 900 4X4 12-14	0214-0922	0214-0922
RZR 1000 14-15 4X4	0214-0928	0214-0928
RZR 1000 16 4X4-S SERIES	0214-1206	0214-1206
RZR 1000 16 4X4-XP	0214-0928	0214-0928
RZR 1000 16 4X4-XP TURBO	0214-0928	0214-0928
RZR 1000 4X4 14	0214-0928	0214-0928
BRUTUS 13-15 4X4	0214-0922	0214-0922
SUZUKI-REARS		
KING QUAD 450 4X4 07-10	0214-0801	0214-0801
KING QUAD 500 4X4 09-12	0214-0801	0214-0801
KING QUAD 700 4X4-08 HOUSING WITH 18X1.5MM THREAD 07	0214-0900	0214-0900
KING QUAD 700 4X4-08 HOUSING WITH 20X1.5MM THREAD 07	0214-0801	0214-0801
KING QUAD 700 4X4 05-06	0214-0900	0214-0900
KING QUAD 750 4X4 08-12	0214-0801	0214-0801
YAMAHA-REARS		
GRIZZLY 350 4X4-W/ IRS 07-11	0214-0509	0214-0509
GRIZZLY 400 4X4 07	0214-0509	0214-0509
KODIAK 400 4X4 05-06	0214-0509	0214-0509
GRIZZLY 450 4X4 07-10	0214-0509	0214-0509
KODIAK 450 4X4 05-06	0214-0509	0214-0509
GRIZZLY 550 4X4 09-13	0214-0514	0214-0514
GRIZZLY 660 4X4 03-05	0214-0280	-
GRIZZLY 660 4X4 02	0214-0379	0214-0380
GRIZZLY 700 4X4 07-13	0214-0514	0214-0514
RHINO 450 4X4 06-09	0214-0343	0214-0344
RHINO 660 4X4 06-07	0214-0343	0214-0344
RHINO 660 4X4 05	0214-0381	0214-0382
RHINO 660 4X4 04	0214-0284	-
RHINO 700 4X4 08-13	0214-0343	0214-0515



PLOWS

WINCHES

UTV

RACKS

IMPLEMENTS
& TOWING

LUGGAGE

BODY

CONTROLS

ELECTRICAL

WHEELS
& TIRESSUSPENSION
& DRIVE

BRAKING

ENGINE

RIDER

GARAGE

PROMO

SUSPENSION & DRIVE



COMPLETE FRONT AXLE ASSEMBLY

The result of quality components and superior engineering. Designed to meet rigid tolerances and to fit OEM applications. Chromoly steel axle bar. Precision ground components. Low profile stainless steel clamps. Assembled with 3% moly grease. Fully assembled outboard and inboard joints.

FITS MODEL	LEFT AXLE PART #	RIGHT AXLE PART #
COMPLETE AXLE ASSEMBLIES		
ARCTIC CAT-FRONT		
250 ALL 01	0214-0971	0214-0975
300 ALL 98-01	0214-0971	0214-0975
400 TRV 09-10	0214-0972	0214-0977
400 FIS 08	0214-0972	0214-0977
400 TRV 08	0214-0977	0214-0977
400 FIS 07	0214-0972	0214-0977
400 TRV 07	0214-0977	0214-0977
400 FIS 06	0214-0972	0214-0977
400 TBX 06	0214-0977	0214-0977
400 TRV 06	0214-0977	0214-0977
400 FIS 05	0214-0970	-
400 TBX 05	0214-0970	0214-0974
400 FIS 04	0214-0976	0214-0976
400 TBX 04	0214-0976	0214-0976
400 FIS 04	0214-0976	0214-0976
400 A/T 00-01	0214-0971	0214-0975
400 M/T 98-01	0214-0975	0214-0975
500 FIS 09	0214-0972	0214-0977
500 FIS 08	0214-0972	0214-0977
500 TRV 08	0214-0972	0214-0977
500 FIS 07	0214-0972	0214-0977
500 FIS 06	0214-0972	0214-0977
500 TBX 06	0214-0977	0214-0977
500 TRV 06	0214-0977	0214-0977
500 FIS 05	0214-0970	0214-0974
500 TBX 05	0214-0970	0214-0974
500 TRV 05	0214-0974	0214-0974
500 FIS 03-04	0214-0976	0214-0976
500 TBX 03-04	0214-0976	0214-0976
500 TRV 03-04	0214-0976	0214-0976
500 FIS 02	0214-0976	0214-0976
500 A/T 00-01	0214-0971	0214-0975
500 M/T 98-01	0214-0975	0214-0975
550 FIS 09-10	0214-0972	0214-0977
550 TRV 09-10	0214-0972	0214-0977
550/XT550 PROWLER 09-10	0214-0973	0214-0978
650 FIS 10	0214-0972	0214-0977
650 TBX 09	0214-0972	0214-0977
650 TRV 09	0214-0972	0214-0977
650 HI FIS 08	0214-0972	0214-0977
650 HI TRV 08	0214-0972	0214-0977
650 HI FIS 07	0214-0972	0214-0977
650 HI TBX 07	0214-0972	0214-0977
650 HI TRV 07	0214-0972	0214-0977
650 HI 06	0214-0972	0214-0977
650 V2 FIS 06	0214-0972	0214-0977
650 HI 05	0214-0970	0214-0974
650 V2 FIS 05	0214-0970	0214-0974
650 V2 FIS 04	-	0214-0976
PROWLER XT650 A/T 06-09	0214-0973	0214-0978
700 HI FIS 08-10	0214-0972	0214-0977
700 TRV 08-10	0214-0972	0214-0977
700 FIS 07	0214-0972	0214-0977
700 FIS 06	0214-0972	0214-0977
PROWLER XT700 08-10	0214-0973	0214-0978
1000 THUNDERCAT FIS 10	0214-0972	0214-0977
1000 TRV 10	0214-0972	0214-0977
1000 MUD PRO 10	0214-0972	0214-0977
1000 THUNDERCAT FIS 09	0214-0972	0214-0977
1000 TRV 09	0214-0972	0214-0977
1000 THUNDERCAT FIS 08	0214-0972	0214-0977
PROWLER 1000XTZ 09-10	0214-0978	0214-0973
WILDCAT 1000 12-14	0214-0979	0214-0979

FITS MODEL	LEFT AXLE PART #	RIGHT AXLE PART #
COMPLETE AXLE ASSEMBLIES (CON'T)		
CAN-AM-FRONT		
OUTLANDER 400 EFI/STD/XT 07-12	0214-1143	0214-1144
OUTLANDER 400 STD/XT 06	-	0214-1144
OUTLANDER 400 MAX EFI/STD/XT 07-12	0214-1143	0214-1144
OUTLANDER 400 MAX STD/XT 06	-	0214-1144
OUTLANDER 500 EFI/STD/DPS/XT 13-14	0214-0986	0214-0993
OUTLANDER 500 EFI/STD/XT 08-12	0214-1143	0214-1144
OUTLANDER 500 STD 07	0214-1143	0214-1144
OUTLANDER 500 MAX EFI/STD/DPS/XT 13-14	0214-0986	0214-0993
OUTLANDER 500 MAX EFI/LTD/STD/XT 08-12	0214-1143	0214-1144
OUTLANDER 500 MAX STD/XT 07	0214-1143	0214-1144
RENEGADE 500 EFI/STD 13-14	0214-0986	0214-0993
RENEGADE 500 EFI 10	0214-1143	0214-1144
RENEGADE 500 08-09	0214-1143	0214-1144
OUTLANDER 650 EFI/STD/DPS/XT 13-15	0214-0986	0214-0993
OUTLANDER 650 EFI-6X6 15	0214-0986	0214-0993
OUTLANDER 650 EFI/STD/XT 12	0214-1143	0214-1144
OUTLANDER 650 EFI 10-11	0214-1143	0214-1144
OUTLANDER 650 EFI/XT 09	0214-1143	0214-1144
OUTLANDER 650 STD/XT 08	0214-1143	0214-1144
OUTLANDER 650 STD/XT 07	0214-1143	0214-1144
OUTLANDER 650 MAX EFI/STD/DPS/X/XT/XT-P 13-15	0214-0986	0214-0993
OUTLANDER 650 MAX EFI/XT/XT-P 12	0214-1143	0214-1144
OUTLANDER 650 MAX EFI 10-11	0214-1143	0214-1144
OUTLANDER 650 MAX EFI/XT 09	0214-1143	0214-1144
OUTLANDER 650 MAX STD/XT 08	0214-1143	0214-1144
OUTLANDER 650 MAX STD/XT 07	0214-1143	0214-1144
OUTLANDER 650 EFI XMR 13-15	0214-1182	0214-1184
OUTLANDER 1000 EFI XMR 13-15	0214-1182	0214-1184
COMMANDER 800 STD DPS XT (MFG UP TO 10/31/14) 15	0214-0989	0214-0996
COMMANDER 800 800 STD, DPS, XT, 14	0214-0989	0214-0996
COMMANDER 800 STD, DPS, XT, 800R EFI(EXC SUPPLEMENT-IS MKT) 13	0214-0989	0214-0996
COMMANDER 800R EFI/STD/XT 12	0214-0985	0214-0992
COMMANDER 800 11	0214-0985	0214-0992
OUTLANDER 800R EFI/STD 15	0214-0986	0214-0993
OUTLANDER 800R EFI/STD/DPS/XT/XT-P 13-14	0214-0986	0214-0993
OUTLANDER 800R EFI/STD/XT (EXC: XMR) 12	0214-0984	0214-0991
OUTLANDER 800R EFI (EXC: XMR/XXC) 11	0214-1143	0214-1144
OUTLANDER 800R EFI 10	0214-1143	0214-1144
OUTLANDER 800R EFI/XT 07-09	0214-1143	0214-1144
OUTLANDER MAX 800R EFI/STD 2015	0214-0986	0214-0993
OUTLANDER MAX 800R EFI/DPS/XT/XT-P 2013-2014	0214-0986	0214-0993
OUTLANDER MAX 800R EFI/STD/XT/XT-P 2012	0214-1143	0214-1144
OUTLANDER MAX 800R EFI/LTD 2010-2011	0214-1143	0214-1144
OUTLANDER MAX 800R EFI/LTD/XT 2009	0214-1143	0214-1144
OUTLANDER MAX 800 STD/LTD/XT 2008	0214-1143	0214-1144
OUTLANDER MAX 800 STD/LTD/XT 2007	0214-1143	0214-1144
RENEGADE 800R EFI/STD/XXC 2013-2015	0214-0986	0214-0993
OUTLANDER 800 EFI XMR 15	0214-1182	0214-1184
RENEGADE 800R STD/XXC 2012	0214-0984	0214-0991
RENEGADE 800R EFI/STD/XXC 2010	0214-1143	0214-1144
RENEGADE 800R EFI/STD/X 2009	0214-1143	0214-1144
RENEGADE 800/X 2008	0214-1143	0214-1144
RENEGADE 800 EFI 2007	0214-1143	0214-1144
COMMANDER 1000 STD DPS XT XTP (MFG UP TO 10/31/14) 2015	0214-0989	0214-0996
COMMANDER MAX 1000 DPS XT (MFG UP TO 10/31/14) 2015	0214-0989	0214-0996
COMMANDER 1000 LTD (MFG UP TO 10/31/14) 2015	0214-0989	0214-0996
COMMANDER 1000 STD, DPS, XT, XT-P 2014	0214-0989	0214-0996
COMMANDER 1000, LTD 2014	0214-0989	0214-0996
COMMANDER MAX 1000 DPS, XT 2014	0214-0989	0214-0996
COMMANDER STD, DPS, XT, X 1000 EFI 2013	0214-0989	0214-0996
COMMANDER LTD 1000 2013	0214-0989	0214-0996
COMMANDER 1000 EFI/STD/LTD/X/XT 2012	0214-0985	0214-0992
COMMANDER 1000 2011	0214-0985	0214-0992
MAVERICK 1000 STD, XRS, XRS-DPS 2015	0214-0987	0214-0994
MAVERICK MAX 1000, STD, XRS-DPS 2015	0214-0987	0214-0994
MAVERICK MAX 1000 XDS-DPS, (TURBO) 2015	0214-0987	0214-0994
MAVERICK 1000 XDS-DPS (TURBO) 2015	0214-0987	0214-0994
MAVERICK 1000 STD, XRS, XRS-DPS 2014	0214-0987	0214-0994
MAVERICK MAX 1000, STD, XRS, XRS-DPS 2014	0214-0987	0214-0994
MAVERICK 1000 2013	0214-0987	0214-0994
OUTLANDER 1000 EFI/STD 2015	0214-0986	0214-0993
OUTLANDER 1000 EFI-6X6 2015	0214-0986	0214-0993
OUTLANDER 1000 EFI/DPS, XT & XT-P 2013-2014	0214-0986	0214-0993
OUTLANDER 1000 EFI/STD/XT 2012	0214-0984	0214-0991
OUTLANDER MAX 1000 EFI/STD/LTD 2015	0214-0986	0214-0993



FITS MODEL	LEFT AXLE PART #	RIGHT AXLE PART #
COMPLETE AXLE ASSEMBLIES (CON'T)		
CAN-AM-FRONTS (CON'T)		
OUTLANDER MAX 1000 EFI/LTD 2014	0214-0986	0214-0993
OUTLANDER MAX 1000 EFI/DPS, XT & XT-P 2014	0214-0986	0214-0993
OUTLANDER MAX 1000 EFI/LTD 2013	0214-0986	0214-0993
OUTLANDER MAX 1000 EFI/DPS, XT & XT-P 2013	0214-0986	0214-0993
RENEGADE 1000 EFI-STD/XXC 2015	0214-0986	0214-0993
RENEGADE 1000 EFI-STD/XXC 2014	0214-0986	0214-0993
RENEGADE 1000 EFI-STD/XXC 2013	0214-0986	0214-0993
RENEGADE 1000 STD/XXC 2012	0214-0984	0214-0991
CF MOTO-FRONTS		
CF500-2 SHORT WB 11-14	0214-1535	0214-1539
CF500-2A LONG WB 11-12, 14	0214-1535	0214-1539
CF500 LONG WB / SHORT WB 01-09	0214-1535	0214-1539
X5 (TERRALANDER 500) LONG WB EFI 11-15	0214-1535	0214-1539
X5 (TERRALANDER 500) LONG WB CARB 11-14	0214-1535	0214-1539
X5 (TERRALANDER 500) SHORT WB EFI 11-12, 14	0214-1535	0214-1539
X5 (TERRALANDER 500) SHORT WB CARB 11-14	0214-1535	0214-1539
X6 (TERRALANDER 625) LONG WB EFI 14	0214-1535	0214-1539
X6 (TERRALANDER 625) LONG WB 11-12	0214-1535	0214-1539
X6 (TERRALANDER 625) SHORT WB EFI 13-14	0214-1535	0214-1539
X6 (TERRALANDER 625) SHORT WB 11-12	0214-1535	0214-1539
X8 (TERRALANDER 800) 12-14	0214-1535	0214-1539
CF800-3 14	0214-1538	0214-1542
500 HO 14-15	0214-1538	0214-1542
800 EX 15	0214-1538	0214-1542
Z6 (TERRACROSS 600) 11-15	0214-1536	0214-1540
Z8 (TERRACROSS 800) 15-16	0214-1537	0214-1541
HISUN-FRONTS		
UTV 500	0214-1543	0214-1545
UTV 600	0214-1543	0214-1545
UTV 700	0214-1543	0214-1545
ATV 500	0214-1544	0214-1546
ATV 600	0214-1544	0214-1546
ATV 700	0214-1544	0214-1546
HONDA-FRONTS		
TRX350 RANCHER 00-05	0214-1033	0214-1033
TRX400 RANCHER 04-07	0214-1032	0214-1032
TRX400 FOREMAN 95-01	0214-1006	0214-1018
TRX420 RANCHER IRS 15-19	0214-1016	0214-1030
TRX420-RANCHER DCT 15-19	0214-1016	0214-1028
TRX420FAI 2AC-RANCHER DCT 14	0214-1016	0214-1028
TRX450 FOREMAN 99-04	0214-1008	0214-1020
TRX500FA5 AC-FOREMAN RUBICON 15-19	0214-1017	0214-1029
TRX500FEI 2AC-FOREMAN ES 15-19	0214-1017	0214-1029
TRX500FA AC-FOREMAN RUBICON 4X4 14	0214-1010	0214-1022
TRX500FEI 2AC-FOREMAN ES 4X4 14	0214-1017	0214-1029
TRX500FA 2AC-FOREMAN RUBICON 4X4 13	0214-1010	0214-1022
TRX500FE 2AC-FOREMAN ES 4X4 13	0214-1010	0214-1022
TRX500FPA 2AC-FOREMAN RUBICON W/EPS 4X4 13	0214-1010	0214-1022
TRX500FPE AC-FOREMAN ES W/EPS 4X4 13	0214-1010	0214-1022
TRX500FA A 11-12	0214-1010	0214-1022
TRX500FM A 09	0214-1010	-
TRX500FA 08	0214-1010	-
TRX500 FOREMAN 05-07	0214-1010	0214-1022
TRX500 RUBICON 01-04	0214-1007	0214-1019
TRX650 RINCON 05-06	0214-1010	0214-1022
TRX650 RINCON 03-04	0214-1009	0214-1021
TRX680FA A 06-19	0214-1010	0214-1022
RINCON 06-07	0214-1010	0214-1022
BIG RED MUV700-ALL MODELS 09-13	0214-1014	0214-1026
PIONEER 500 15-16	0214-1186	0214-1187
PIONEER 700 SXS700-15-16	0214-1015	0214-1027
KYMCO-FRONTS		
500I/500I IRS ALL	0214-1547	0214-1548
KAWASAKI-FRONTS		
KLF300 BAYOU 89-05	0214-1056	0214-1056
KVF300 PRAIRIE 99-02	0214-1054	0214-1054
KVF360 PRAIRIE 09-12	0214-1041	0214-1046
KVF360 PRAIRIE 03-08	0214-1041	0214-1046
KLF400 BAYOU 93-99	0214-1056	0214-1056
KVF400 PRAIRIE 97-02	0214-1051	0214-1051
MULE 610 KAF400AFF 08-19	0214-1053	0214-1053
KVF650 BRUTE FORCE 05-13	0214-1041	0214-1046
KVF650 PRAIRIE 02-03	0214-1041	0214-1046
KVF650 BRUTE FORCE I 06-13	0214-1043	0214-1048
KVF700 PRAIRIE 04-06	0214-1041	0214-1046
TERYX 750 08-13	0214-1052	0214-1052

FITS MODEL	LEFT AXLE PART #	RIGHT AXLE PART #
COMPLETE AXLE ASSEMBLIES (CON'T)		
KAWASAKI-FRONTS (CON'T)		
KVF750 BRUTE FORCE 05-07	0214-1043	0214-1048
KVF750 BRUTE FORCE 08-11	0214-1042	0214-1047
KVF750 BRUTE FORCE 12-19	0214-1043	0214-1048
2510 MULE KAF620/KAF950 DIESEL 00-02	0214-1055	0214-1055
3010 MULE KAF620/KAF950 DIESEL 01-08	0214-1055	0214-1055
4010 MULE 09-19	0214-1055	0214-1055
POLARIS-FRONTS		
250 XPLORER 00-02	0214-1152	0214-1152
300 HAWKEYE 06-07	0214-1073	0214-1073
300 SPORTSMAN 08-10	0214-1073	0214-1073
325 RANGER ETX 15-16	0214-1193	0214-1193
325 SPORTSMAN ETX 15	0214-1078	0214-1078
330 ATP 04	0214-1149	0214-1149
330 MAGNUM 03-04	0214-1149	0214-1149
400 RANGER 10-14	0214-1072	0214-1072
400 SCRAMBLER 00-02	0214-1152	0214-1152
400 SPORTSMAN 02-03	0214-1152	0214-1152
400 SPORTSMAN A04CH42AQ/AV MALE INBOARD SPLINE YOKE 04	0214-1149	0214-1149
400 SPORTSMAN A05MH42AB/AG/AH 05	0214-1065	0214-1065
400 SPORTSMAN HO 08-10	0214-1073	0214-1073
400 SPORTSMAN HO 13-14	0214-1078	0214-1078
400 SPORTSMAN W958040 STAMPED (USA) ON HOUSING 95	0214-1152	0214-1152
400 SPORTSMAN W967840 STAMPED (USA) ON HOUSING 96	0214-1152	0214-1152
400 XPLORER A99CG/00CG/01CG/02CG-38CA 99-02	0214-1152	0214-1152
400 XPLORER W959140 STAMPED (USA) ON HOUSING 95-96	0214-1152	0214-1152
425 MAGNUM S&N958144 INTL STAMPED (USA) 95	0214-1152	0214-1152
425 MAGNUM S968144 (SWEDEN) STAMPED (USA) ON HOUSING 96	0214-1152	0214-1152
425 MAGNUM S968744 (SWEDEN) STAMPED (USA) ON HOUSING 6X6 96	0214-1152	0214-1152
425 MAGNUM W968144 STAMPED (USA) ON HOUSING 96	0214-1152	0214-1152
425 MAGNUM W968744 STAMPED (USA) ON HOUSING 6X6 96	0214-1152	0214-1152
425 XPEdition A02CK42AA/AB 02	0214-1152	0214-1152
450 SPORTSMAN A06MH46AA 06	0214-1074	0214-1074
500 BIG BOSS 6X6 02	0214-1152	0214-1152
500 MAGNUM 02	0214-1152	0214-1152
500 RANGER 06-07	0214-1068	0214-1068
500 RANGER 08	0214-1067	0214-1067
500 RANGER 09-10	0214-1069	0214-1069
500 RANGER 4X4 19	0214-1193	0214-1193
500 RANGER MIDSIZE&CREW 11-13	0214-1072	0214-1072
500 SCRAMBLER 04-09	0214-1152	0214-1152
500 SCRAMBLER 99-03	0214-1152	0214-1152
500 SPORTSMAN A03CL50AA 4X4/6X6 02-03	0214-1152	0214-1152
500 SPORTSMAN A04CH50AA/AC/AE/AG FEMALE INBOARD YOKE 04	0214-1152	0214-1152
500 SPORTSMAN A04CH50AA/AX MALE INBOARD SPLINED YOKE 04	0214-1149	0214-1149
500 SPORTSMAN A05MH50AB/FB 05	0214-1065	0214-1065
500 SPORTSMAN A06MH50AA/AX/AY/AZ/AL/AT 06	0214-1074	0214-1074
500 SPORTSMAN A13MH50AJ/AQ/AX/AZ 13	0214-1078	0214-1078
500 SPORTSMAN HO A03CH50AA/AB/AC/AD/AE/AH/AJ 03	0214-1152	0214-1152
500 SPORTSMAN HO A04CG50AA/AX (MALE INBOARD YOKE) 04	0214-1149	0214-1149
500 SPORTSMAN HO A04CH50AA/AC/AE/AG (FEMALE INBOARD YOKE) 04	0214-1152	0214-1152
500 SPORTSMAN HO A05MH50AB (INTL) 05	0214-1065	0214-1065
500 SPORTSMAN HO A06MH50AA/AB/AD/AF MFG. AFTER 10/03/06 06	0214-1065	0214-1065
500 SPORTSMAN HO A06MH50AA/AB/AD/AF MFG. BEFORE 10/03/06 06	0214-1074	0214-1074
500 SPORTSMAN HO A13DH50AA/AZ HO TOURING 13	0214-1078	0214-1078
500 SPORTSMAN HO A13MH50AJ/AQ/AX/AZ 13	0214-1078	0214-1078
500 SPORTSMAN HOA06MH50FB/FC (INTL) 06	0214-1074	0214-1074
500 SPORTSMAN S969244 (SWEDEN) STAMPED (USA) ON HOUSING 96	0214-1152	0214-1152
500 SPORTSMAN W97CH50A 97	0214-1152	0214-1152
500 XPLORER W97CD50A 97	0214-1152	0214-1152
550 SPORTSMAN A14ZN5EAB/C/M/S XP EPS 09-14	0214-1070	0214-1070
550 SPORTSMAN X2 10-14	0214-1070	0214-1070
570 RANGER 15-18	0214-1193	0214-1193
570 RANGER 19	0214-1193	0214-1193
570 RANGER CREW 15-18	0214-1193	0214-1193
570 RANGER CREW 19	0214-1193	0214-1193
570 RANGER CREW EPS 15-18	0214-1193	0214-1193
570 RANGER CREW EPS 19	0214-1193	0214-1193
570 RANGER EPS 15-18	0214-1193	0214-1193
570 RANGER EPS 19	0214-1193	0214-1193
570 RANGER HD 19	0214-1193	0214-1193
570 RANGER MID SIZE 15-16	0214-1193	0214-1193
570 RANGER R15RUA57AA/E57AC-EFI CREW (FULL SIZE ONLY) 15	0214-1066	0214-1066
570 RZR EFI 12-19	0214-1064	0214-1064
570 RZR EPS 18	0214-1064	0214-1064
570 RZR EU 15-18	0214-1064	0214-1064
570 RZR Z16VHA57A2/AK 12-16	0214-1064	0214-1064

SUSPENSION & DRIVE

FITS MODEL	LEFT AXLE PART #	RIGHT AXLE PART #
COMPLETE AXLE ASSEMBLIES (CON'T)		
POLARIS-FRONT (CON'T)		
570 SPORTSMAN A15SEH57AD-HD 14-15	0214-1078	0214-1078
600 SPORTSMAN A03CH59AA/AF/AG MFG. AFTER 10/03/02 03	0214-1149	0214-1149
600 SPORTSMAN A03CH59AA/AF/AG MFG. BEFORE 10/03/02 03	0214-1149	0214-1149
600 SPORTSMAN A04CH59AF/AH/AJ/AT/AV 04	0214-1149	0214-1149
600 SPORTSMAN A05MH59AK/AN 05	0214-1065	0214-1065
700 RANGER LE R07RH68AD/AG/AH/AK/AL/AQ/AP/AW 07	0214-1068	0214-1068
700 RANGER R08RF68AD/AF/AZ 6X6 08	0214-1067	0214-1067
700 RANGER R08RH68 EFI/XP ALL OPTIONS 08	0214-1067	0214-1067
700 RANGER R08WH68AG/AH/AK/AR CREW 08	0214-1067	0214-1067
700 RANGER R09HH68/HY68 ALL EXPT CREW & 6X6 09	0214-1069	0214-1069
700 RANGER R09RF68AF/AR/AZ 6X6 09	0214-1067	0214-1067
700 RANGER R09WH68AC/AG/AH/AL/AR/AZ CREW 09	0214-1067	0214-1067
700 RANGER XP R06RD68AA/AB/AC/AD/AE/AF 06	0214-1068	0214-1068
700 SPORTSMAN A02CH68AA/AB/AC/CA/CB MFG. AFTER 5/01/02 02	0214-1149	0214-1149
700 SPORTSMAN A03CH68AA/AC/AF/AH/AL MFG. AFTER 10/03/02 03	0214-1149	0214-1149
700 SPORTSMAN A03CH68AA/AC/AF/AH/AL MFG. BEFORE 10/03/02 03	0214-1149	0214-1149
700 SPORTSMAN A04CH68AC/AF/AH/AJ/AT/AV 04	0214-1149	0214-1149
700 SPORTSMAN A05MH68AK/AN/AD 05	0214-1065	0214-1065
700 SPORTSMAN A06MH68AA/AD/AF/AQ/AT/AX/AY/AZ 06	0214-1074	0214-1074
800 RANGER ALL/CREW FULLSIZE 4X4/6X6 10-16	0214-1069	0214-1069
800 RANGER R13RH76AG/AH/AN EFI MIDSIZE 13-14	0214-1072	0214-1072
800 RZR 08-14	0214-1064	0214-1064
800 RZR Z14XE7EAL RZR 4/RZR S 09-14	0214-1066	0214-1066
800 SPORTSMAN A05MH76AC/AT/AU/AW 05	0214-1065	0214-1065
800 SPORTSMAN A06MH76AL-AZ MFG. AFTER 11/11/05 06	0214-1074	0214-1074
800 SPORTSMAN A06MH76AL-AZ MFG. BEFORE 9/5/05 06	0214-1074	0214-1074
800 SPORTSMAN A06MH76AL-AZ MFG. BETWEEN 9/5/05 & 11/11/05 06	0214-1065	0214-1065
800 SPORTSMAN A14CF76AA EFI 6X6 13-14	0214-1078	0214-1078
800 SPORTSMAN A14MH76AA/AH EFI 13-14	0214-1078	0214-1078
850 SCRAMBLER 13-14	0214-1070	0214-1070
850 SPORTSMAN ALL 09-15	0214-1070	0214-1070
850 SPORTSMAN HD A14DN8EAH/EAQ/EAR EPS/HO TOURING 13-14	0214-1070	0214-1070
900 RANGER CREW 19	0214-1066	0214-1066
900 RANGER CREW EPS 19	0214-1066	0214-1066
900 RANGER R13TH90DG DIESEL 11-13	0214-1076	0214-1076
900 RANGER R14TH90DG DIESEL 14	0214-1076	0214-1076
900 RANGER R14WH88A/9EA CREW-ALL EXPT. DIESEL 14-15	0214-1066	0214-1066
900 RANGER R16RT 87 XP-ALL EXPT. DIESEL 15-16	0214-1066	0214-1066
900 RANGER R16RUA/RUE/RVA/RVE CREW-ALL EXPT. DIESEL 15-16	0214-1066	0214-1066
900 RANGER XP 13-18	0214-1066	0214-1066
900 RANGER XP 19	0214-1066	0214-1066
900 RANGER XP EPS 19	0214-1066	0214-1066
900 RANGER XP R13UH88/UH9E XP ALL EXPT. DIESEL 13-14	0214-1066	0214-1066
900 RZR 4 15-18	0214-1192	0214-1192
900 RZR 4 XP 15-16	0214-1192	0214-1192
900 RZR 50 INCH 18-19	0214-1191	0214-1191
900 RZR 50 INCH EPS 18-19	0214-1191	0214-1191
900 RZR 60 INCH 16-19	0214-1192	0214-1192
900 RZR S XP 127 CM (50") 15-16	0214-1191	0214-1191
900 RZR S XP 152 CM (60") 15-16	0214-1192	0214-1192
900 RZR XP Z14J187AD/9EAO 11-14	0214-1071	0214-1071
1000 GENERAL 16	0214-1192	0214-1192
1000 GENERAL 4 EPS 17-18	0214-1192	0214-1192
1000 GENERAL EPS 16-18	0214-1192	0214-1192
1000 GENERAL EPS 19	0214-1192	0214-1192
1000 RANGER DIESEL 15-18	0214-1066	0214-1066
1000 RANGER DIESEL CREW 15-18	0214-1066	0214-1066
1000 RANGER EPS BASE 18	0214-1066	0214-1066
1000 RANGER EPS BASE 19	0214-1066	0214-1066
1000 RANGER EPS HD MD 19	0214-1066	0214-1066
1000 RANGER R16RTAD1A1/E1-DIESEL 15-16	0214-1066	0214-1066
1000 RANGER XP EPS CREW 19	0214-1066	0214-1066
1000 RANGER XP EPS CREW NSTR 19	0214-1066	0214-1066
1000 RZR 15	0214-1190	0214-1190
1000 RZR 16 XP 4 BUILT 10/19/15 & BEFORE	0214-1190	0214-1190
1000 RZR 16 XP EU/MD BUILT 10/19/15 & BEFORE	0214-1190	0214-1190
1000 RZR 16 XP BUILT 10/19/15 & BEFORE	0214-1190	0214-1190
1000 RZR 60 INCH 16-19	0214-1192	0214-1192
1000 RZR S 152 CM (60") 16	0214-1192	0214-1192
1000 RZR S4 19	0214-1192	0214-1192
1000 SCRAMBLER A15SVE95HW-MD 14-15	0214-1070	0214-1070
1000 SPORTSMAN A15SXE95AC/AK-XP 15	0214-1070	0214-1070
BRUTUS D131D9JD/1L9JD/2M9JD STD/HD/PTO 13	0214-1066	0214-1066
EV RANGER 15-17	0214-1193	0214-1193
EV RANGER EV 4X4 15-19	0214-1193	0214-1193
EV RANGER EV LIION 16-18	0214-1193	0214-1193

FITS MODEL	LEFT AXLE PART #	RIGHT AXLE PART #
COMPLETE AXLE ASSEMBLIES (CON'T)		
SUZUKI-FRONT		
400 KING QUAD 08-12, 14-18	0214-1200	0214-1201
450 KING QUAD LT-A450X/LT-A450XZ 07-09	0214-1108	0214-1108
500 KING QUAD LT-A500X 11-14	0214-1108	0214-1108
500 KING QUAD 09-18	0214-1202	0214-1202
500 WINSON LT-A500F 04-07	0214-1106	0214-1107
700 KING QUAD LT-A700X 05-07	0214-1108	0214-1108
750 KING QUAD LT-A750X 08-09, 11-18	0214-1108	0214-1108
750 KING QUAD 09-18	0214-1202	0214-1202
YAMAHA-FRONT		
BIG BEAR YFM350FVBL/FHLC 97-99	0214-1123	0214-1123
BRUIN YFM350FAHV/FAV 04-06	0214-1125	0214-1125
GRIZZLY 350 YFM350DEG/DEL/DER/DHEH 12-14	0214-1130	0214-1130
GRIZZLY 350 YFM350FGW 07-11	0214-1125	0214-1125
YFM350 WOLVERINE 95-00	0214-1123	0214-1123
BIG BEAR YFM400FV/FM/FMC 40FHN 00-01	0214-1123	0214-1123
BIG BEAR YFM400FV 02-06	0214-1126	0214-1126
BIG BEAR YFM400FBGR/FBBL/FBHB 12	-	0214-1130
GRIZZLY 400 YFM400FGHX/FGX/FGXB 07-08	0214-1125	0214-1125
KODIAK YFM400FVBL/BLC 99	0214-1123	0214-1123
KODIAK YFM400FV/FVHP/FHAP 00-02	0214-1124	0214-1124
KODIAK YFM400FAV 03-06	0214-1125	0214-1125
GRIZZLY 450 12-14	0214-1130	-
GRIZZLY 450 07	0214-1110	0214-1115
KODIAK 450 03-07	0214-1110	0214-1115
RHINO 450 06-09	0214-1112	0214-1117
WOLVERINE YFM450FXZW 06-10	0214-1125	0214-1125
GRIZZLY 550 YFM550FG-ALL 09-14	0214-1120	0214-1120
GRIZZLY 660 03-08	0214-1111	0214-1116
RHINO 660 06-07	0214-1112	0214-1117
GRIZZLY YFM700-ALL 14-15	0214-1129	0214-1129
GRIZZLY YFM700FG-ALL 07-13	0214-1120	0214-1120
RHINO 700 08-09, 11-13	0214-1131	0214-1131
WOLVERINE 700 16-18	0214-1174	0214-1174
VIKING 700 14-19	0214-1174	0214-1174
ARCTIC CAT-REARS		
1000 THUNDERCAT FIS 08-10	0214-0981	0214-0981
1000 TRV 09-10	0214-0981	0214-0981
1000 MUD PRO 10	0214-0981	0214-0981
400 TRV/FIS/TRV/TBX 05-10	0214-0981	0214-0981
400 FIS/TBX 02-04	0214-0976	0214-0976
500 FIS/TRV/TBX 05-09	0214-0981	0214-0981
500 FIS/TBX/TRV 03-04	0214-0976	0214-0976
550 FIS/TRV 09-10	0214-0981	0214-0981
550/XT350 PROWLER U2009P104B0&USG 09-10	0214-0982	0214-0982
650 FIS/TBX/TRV/HI/V2 04-10	0214-0981	0214-0981
650HI/XT650 PROWLER 06-09	0214-0982	0214-0982
700 HI FIS/TRV/FIS 06-10	0214-0981	0214-0981
XTX700 PROWLER 08-10	0214-0973	0214-0973
XTZ1000 PROWLER 09-10	0214-0982	0214-0982
WILDCAT 1000-(STD/LTD/4X) EXCLUDES TRAIL OR SPORT MODELS 12-14	0214-0983	0214-0983
CAN AM-REARS		
OUTLANDER MAX 400 EFI/STD/XT 13-15	-	0214-1005
OUTLANDER 500 EFI/STD (EXC: L) 15	-	0214-1005
OUTLANDER 500 EFI/STD/DPS/XT 13-14	-	0214-1005
OUTLANDER 500 STD 07	-	0214-1005
OUTLANDER MAX 500 EFI/STD (EXC: L) 15	-	0214-1005
OUTLANDER MAX 500 EFI/STD/DPS/XT 13-14	-	0214-1005
OUTLANDER MAX 500 STD/XT 07	-	0214-1005
RENEGADE 500 EFI/STD 13-15	-	0214-1005
OUTLANDER 650 EFI/STD/DPS/XT 13-15	-	0214-1005
OUTLANDER 650 EFI-6X6 15	-	0214-1005
OUTLANDER 650 EFI XMR 13-15	-	0214-1005
OUTLANDER 650 STD/XT 06-07	-	0214-1005
OUTLANDER MAX 650 EFI/STD/DPS/X/XT/XT-P 13-15	-	0214-1005
OUTLANDER MAX 650 STD/XT 06-07	-	0214-1005
COMMANDER 800 STD DPS XT (ALL) 13-15	0214-1003	0214-1003
OUTLANDER 800R EFI/STD 15	-	0214-1005
OUTLANDER 800R EFI/STD/DPS/XT/XT-P 13-14	-	0214-1005
OUTLANDER 800 STD/XT 06-07	-	0214-1005
OUTLANDER MAX 800R EFI/STD 15	-	0214-1005
OUTLANDER MAX 800R EFI/DPS/XT/XT-P 13-14	-	0214-1005
OUTLANDER MAX 800 STD/LTD/XT 06-07	-	0214-1005
RENEGADE 800R EFI/STD/XXC 13-15	-	0214-1005
RENEGADE 800 EFI 07	-	0214-1005
COMMANDER LTD 1000 13-15 (ALL)	0214-1003	0214-1003
MAVERICK 1000 STD, XRS, XRS-DPS 15	0214-1145	0214-1145
MAVERICK 1000 XXC 15	0214-1146	0214-1146



FITS MODEL	LEFT AXLE PART #	RIGHT AXLE PART #
COMPLETE AXLE ASSEMBLIES (CON'T)		
CAN AM-REARS (CON'T)		
MAVERICK MAX 1000, STD, XRS-DPS 15	0214-1145	0214-1145
MAVERICK MAX 1000 XDS-DPS, (TURBO) 15	0214-1148	0214-1148
MAVERICK 1000 XDS-DPS (TURBO) 15	0214-1148	0214-1148
MAVERICK 1000 STD, XRS, XRS-DPS 14	0214-1145	0214-1145
MAVERICK 1000 STD 13-18	0214-1145	0214-1145
MAVERICK 1000 XXC 14	0214-1146	0214-1146
MAVERICK 1000 XMR 14	0214-1145	0214-1145
MAVERICK MAX 1000, STD, XRS, XRS-DPS 14	0214-1145	0214-1145
MAVERICK 1000 13	0214-1145	0214-1145
OUTLANDER 1000 EFI/STD 13-15	-	0214-1005
OUTLANDER 1000 EFI-6X6 15	-	0214-1005
OUTLANDER MAX 1000 EFI/STD/LTD-ALL 13-15	-	0214-1005
RENEGADE 1000 EFI-STD/XXC 13-15	-	0214-1005
CF MOTO-REARS		
CF500-2 SHORT WB 11-14	0214-1549	0214-1554
CF500-2A LONG WB 11-12, 14	0214-1549	0214-1554
CF500 LONG WB / SHORT WB 01-09	0214-1549	0214-1554
X5 (TERRALANDER 500) LONG WB EFI 11-15	0214-1549	0214-1554
X5 (TERRALANDER 500) LONG WB CARB 11-14	0214-1549	0214-1554
X5 (TERRALANDER 500) SHORT WB EFI 11-12, 14	0214-1549	0214-1554
X5 (TERRALANDER 500) SHORT WB CARB 11-14	0214-1549	0214-1554
X6 (TERRALANDER 625) LONG WB EFI 14	0214-1549	0214-1554
X6 (TERRALANDER 625) LONG WB 11-12	0214-1549	0214-1554
X6 (TERRALANDER 625) SHORT WB EFI 13-14	0214-1549	0214-1554
X6 (TERRALANDER 625) SHORT WB 11-12	0214-1549	0214-1554
X8 (TERRALANDER 800) 12-14	0214-1549	0214-1554
CF800 13-14	0214-1551	0214-1556
500 HO 14-15	0214-1553	0214-1557
800 EX 15	0214-1553	0214-1557
Z6 (TERRACROSS 600) 11-15	0214-1550	0214-1555
Z8 (TERRACROSS 800) 15-16	0214-1552	0214-1558
HISUN-REARS		
UTV 500	0214-1559	0214-1561
UTV 600	0214-1559	0214-1561
UTV 700	0214-1559	0214-1561
ATV 500	0214-1560	0214-1562
ATV 600	0214-1560	0214-1562
ATV 700	0214-1560	0214-1562
HONDA-REARS		
TRX420FA5 2AC-RANCHER AUTO DCT IRS 15-19	0214-1040	0214-1040
TRX420FA AC-RANCHER AT W/IRS 14	0214-1034	0214-1035
TRX420FA AC/FA 2AC 09-13	0214-1034	0214-1035
TRX500 FOREMAN RUBICON 15-16	0214-1040	0214-1040
TRX650 RINCON 03-06	0214-1031	0214-1031
TRX680 RINCON 06-19	0214-1031	0214-1031
BIG RED 700 09-13	0214-1036	0214-1037
PIONEER 500 15-16	0214-1188	0214-1188
PIONEER 700 14	0214-1038	0214-1038
PIONEER 700 15-16	0214-1189	0214-1189
KYMCO-REARS		
500I/500I IRS ALL	0214-1563	0214-1564
KAWASAKI-REARS		
650I BRUTE FORCE 06-13	0214-1057	0214-1057
750 TERYX 12-13	0214-1058	0214-1058
750 TERYX 08-11	0214-1060	0214-1061
750I BRUTE FORCE (4X4I EPS) 05-19	0214-1057	0214-1057
POLARIS-MIDDLE		
700 RANGER 6X6 09	0214-1197	0214-1197
800 RANGER 6X6 14-16	0214-1197	0214-1197
POLARIS-REARS		
300 HAWKEYE 06-10	0214-1088	0214-1088
300 SPORTSMAN 08-10	0214-1088	0214-1088
325 HAWKEYE 15	0214-1196	0214-1196
325 RANGER ETX 15-16	0214-1100	0214-1100
325 SPORTSMAN ACE 14-15	0214-1097	0214-1097
325 SPORTSMAN ETX 15	0214-1196	0214-1196
335 SPORTSMAN WITH CV JOINT 00	0214-1063	0214-1063
400 HAWKEYE HO 2X4 11-14	0214-1083	0214-1083
400 RANGER MIDSIZE 10-14	0214-1090	0214-1090
400 SPORTSMAN 01-02	0214-1063	0214-1063
400 SPORTSMAN 03-05	0214-1062	0214-1062
400 SPORTSMAN HO 08-10	0214-1088	0214-1088
400 SPORTSMAN HO 11-14	0214-1083	0214-1083
450 SPORTSMAN 16	0214-1196	0214-1196
500 ACE 17-19	0214-1097	0214-1097
500 RANGER 05-06	0214-1101	0214-1102

FITS MODEL	LEFT AXLE PART #	RIGHT AXLE PART #
COMPLETE AXLE ASSEMBLIES (CON'T)		
POLARIS-REARS (CON'T)		
500 RANGER 11-13	0214-1090	0214-1090
500 RANGER 2WD 17-19	0214-1100	0214-1100
500 RANGER 2X4 05-06	0214-1101	0214-1102
500 RANGER 2X4 09	0214-1081	0214-1082
500 RANGER CREW 11-13	0214-1090	0214-1090
500 RANGER EFI 09	0214-1081	0214-1082
500 RANGER EFI 10	0214-1084	0214-1084
500 RANGER MFG. AFTER 8/28/06 07	-	0214-1082
500 RANGER MFG. BEFORE 8/28/06 07	0214-1101	0214-1102
500 SPORTSMAN 03-05	0214-1062	0214-1062
500 SPORTSMAN 06-10	0214-1095	0214-1095
500 SPORTSMAN 11-14	0214-1083	0214-1083
500 SPORTSMAN 99-02	0214-1063	0214-1063
500 SPORTSMAN HO 03-05	0214-1062	0214-1062
500 SPORTSMAN HO 06,08-10	0214-1095	0214-1095
500 SPORTSMAN HO 11-13	0214-1083	0214-1083
500 SPORTSMAN HO TOURING 11-13	0214-1085	0214-1085
500 SPORTSMAN HOTOURING 10	0214-1092	0214-1092
500 SPORTSMAN TOURING 08-09	0214-1092	0214-1092
500 SPORTSMAN X2 07	0214-1092	0214-1092
500 SPORTSMAN X2 08-09	0214-1092	0214-1092
550 SPORTSMAN X2 10-14	0214-1089	0214-1089
550 SPORTSMAN XP 09	0214-1091	0214-1091
550 SPORTSMAN XP EPS 10-14	0214-1089	0214-1089
570 ACE 18-19	0214-1097	0214-1097
570 ACE EU 15-18	0214-1097	0214-1097
570 ACE HD 15-19	0214-1097	0214-1097
570 RANGER-(FULL SIZE ONLY) 15	0214-1105	0214-1105
570 RANGER-EFI CREW (FULL SIZE ONLY) 15	0214-1105	0214-1105
570 RANGER-EFI CREW (MID SIZE ONLY) 15	0214-1100	0214-1100
570 RANGER-EU (MID SIZE ONLY) 15	0214-1100	0214-1100
570 RANGER (MID SIZE ONLY) 15	0214-1100	0214-1100
570 RANGER 15-18	0214-1100	0214-1100
570 RANGER 6 FULL SIZE CREW 17-18	0214-1100	0214-1100
570 RANGER CREW 15-18	0214-1100	0214-1100
570 RANGER CREW EPS 15-18	0214-1100	0214-1100
570 RANGER EPS 15-18	0214-1100	0214-1100
570 RZR 12-16	0214-1097	0214-1097
570 RZR EFI 12-19	0214-1097	0214-1097
570 RZR EFI EPS 19	0214-1097	0214-1097
570 RZR EPS 18	0214-1097	0214-1097
570 RZR EU 15-18	0214-1097	0214-1097
570 SPORTSMAN (ALL) 15-16	0214-1196	0214-1196
570 SPORTSMAN 14	0214-1083	0214-1083
570 SPORTSMAN ACE-EFI 15	0214-1097	0214-1097
570CC RANGER FULL SIZE 17-18	0214-1100	0214-1100
600 SPORTSMAN 03-05	0214-1062	0214-1062
700 RANGER LE R07RH68AD/G/H/K/L/O/P/W MFG. AFTER 8/28/26 07	-	0214-1082
700 RANGER LE R07RH68AD/G/H/K/L/O/P/W MFG. BEFORE 8/28/06 07	0214-1101	0214-1102
700 RANGER R08RH68 EFI/XP ALL OPTIONS 08	-	0214-1082
700 RANGER R08WH68AG/AH/AK/AR CREW 08	-	0214-1082
700 RANGER R09HH68/HY68 ALL EXPT CREW & 6X6 09	0214-1081	0214-1082
700 RANGER R09WH68AC/AG/AH/AL/AR/AZ CREW 09	0214-1081	0214-1082
700 RANGER XP 05-06	0214-1101	0214-1102
700 SPORTSMAN 03-05	0214-1062	0214-1062
700 SPORTSMAN 06-07	0214-1095	0214-1095
700 SPORTSMAN X2 08	0214-1092	0214-1092
800 RANGER EFI CREW 10-13	0214-1084	0214-1084
800 RANGER R10HR76AG/AR EFI 6X6 10-16	0214-1081	0214-1082
800 RANGER R10TH76TY EFI 10-12	0214-1084	0214-1084
800 RANGER R13RH76AG/AH/AN EFI MIDSIZE 13-14	0214-1090	0214-1090
800 RZR "S" & RZR "4" 09-14	0214-1086	0214-1086
800 RZR 08-14	0214-1098	0214-1098
800 SPORTSMAN 11-14	0214-1083	0214-1083
800 SPORTSMAN A05MH76AC/AT/AU/AW 05	0214-1062	0214-1062
800 SPORTSMAN A07MN76AF/AT/AY 06-07	0214-1095	0214-1095
800 SPORTSMAN A08DN76AF/AG/AH/AL/AJ/AS TOURING 08	0214-1092	0214-1092
800 SPORTSMAN A08DN76FC INTL 08	0214-1092	0214-1092
800 SPORTSMAN A09CL76AA 6X6 09	0214-1095	0214-1095
800 SPORTSMAN A09DN76AB/AL/AY 09	0214-1092	0214-1092
800 SPORTSMAN A09DN76FC INTL 09	0214-1092	0214-1092
800 SPORTSMAN A09MN76AX/AZ 09	0214-1095	0214-1095
800 SPORTSMAN A10CL76AA 6X6 10	0214-1095	0214-1095
800 SPORTSMAN A10MN76AX/AZ 10	0214-1095	0214-1095
800 SPORTSMAN HO 08-09	0214-1095	0214-1095
800 SPORTSMAN X2 08-09	0214-1092	0214-1092

SUSPENSION & DRIVE

FITS MODEL	LEFT AXLE PART #	RIGHT AXLE PART #
COMPLETE AXLE ASSEMBLIES (CON'T)		
POLARIS-REARS (CON'T)		
800 SPORTSMAN X2 A07TH76AU MFG. BEFORE 7/25/07	0214-1092	0214-1092
850 SCRAMBLER 13-14	0214-1089	0214-1089
850 SCRAMBLER 18	0214-1089	0214-1089
850 SPORTSMAN 09	0214-1091	0214-1091
850 SPORTSMAN 10-15	0214-1089	0214-1089
850 SPORTSMAN HIGH LIFTER 18-19	0214-1089	0214-1089
850 SPORTSMAN HO 13-14	0214-1089	0214-1089
850 SPORTSMAN SP 18	0214-1089	0214-1089
850 SPORTSMAN TOURING 19	0214-1089	0214-1089
850 SPORTSMAN TOURING SP 18	0214-1089	0214-1089
900 RANGER R13TH90DG DIESEL/DIESEL CREW 11-14	0214-1103	0214-1104
900 RANGER R13UH88/UH9E XP & CREW 13-16	0214-1105	0214-1105
900 RANGER XP 13-18	0214-1105	0214-1105
900 RZR 50 INCH EPS 18-19	0214-1198	0214-1198
900 RZR 4 15-18	0214-1199	0214-1199
900 RZR 50 INCH 18-19	0214-1198	0214-1198
900 RZR 60 INCH 16-19	0214-1199	0214-1199
900 RZR XP 11-14	0214-1087	0214-1087
900 RZR XP 15-16 RZR 4	0214-1199	0214-1199
900 RZR XP 15-16 60 INCH ALL	0214-1199	0214-1199
900 RZR XP 15-16 S 127 CM (50")	0214-1198	0214-1198
925 RZR TURBO 16	0214-1195	0214-1195
1000 GENERAL 16	0214-1199	0214-1199
1000 GENERAL 4 EPS 17-18	0214-1199	0214-1199
1000 GENERAL EPS 16-18	0214-1199	0214-1199
1000 RANGER 15-16	0214-1105	0214-1105
1000 RANGER DIESEL 15-18	0214-1105	0214-1105
1000 RANGER DIESEL CREW 15-18	0214-1105	0214-1105
1000 RANGER EPS BASE 18	0214-1105	0214-1105
1000 RANGER XP EPS CREW 19	0214-1105	0214-1105
1000 RZR 16 XP	0214-1195	0214-1195
1000 RZR 16 S 60 IN	0214-1199	0214-1199
1000 RZR 60 INCH 16-19	0214-1199	0214-1199
1000 RZR RS1 18-19	0214-1195	0214-1195
1000 RZR S4 19	0214-1199	0214-1199
1000 RZR XP 14-15	0214-1099	0214-1099
1000 RZR XP 17-19	0214-1195	0214-1195
1000 RZR XP 4 17-19	0214-1195	0214-1195
1000 RZR XP 4 TURBO 16-19	0214-1195	0214-1195
1000 RZR XP 4 TURBO 18	0214-1195	0214-1195
1000 RZR XP TURBO 16-19	0214-1195	0214-1195
1000 SCRAMBLER TRACTOR 18	0214-1089	0214-1089
1000 SCRAMBLER XP 14-15	0214-1089	0214-1089
1000 SCRAMBLER XP 18	0214-1089	0214-1089
1000 SPORTSMAN 1000 XP 18	0214-1089	0214-1089
1000 SPORTSMAN 1000 XP TRACTOR 18	0214-1089	0214-1089
1000 SPORTSMAN 15	0214-1089	0214-1089
1000 SPORTSMAN HIGH LIFTER 18-19	0214-1089	0214-1089
1000 SPORTSMAN TOURING 1000 TRACTOR 18	0214-1089	0214-1089
1000 SPORTSMAN TOURING 18-19	0214-1089	0214-1089
EY RANGER 13-15	0214-1090	0214-1090
SUZUKI-REARS		
450 KING QUAD 07-09	0214-1109	0214-1109
500 KING QUAD 09,11-18	0214-1109	0214-1109
700 KING QUAD 05-07	0214-1109	0214-1109
750 KING QUAD 08-09, 11-18	0214-1109	0214-1109
YAMAHA-REARS		
350 GRIZZLY 07-11	0214-1128	0214-1128
400 GRIZZLY 08	0214-1128	0214-1128
400 GRIZZLY 07	0214-1128	0214-1128
400 KODIAK 05-06	0214-1128	0214-1128
450 GRIZZLY 08-10	0214-1128	0214-1128
450 GRIZZLY 07	0214-1128	0214-1128
450 KODIAK 05-07	0214-1128	0214-1128
450 RHINO 06-09	0214-1132	0214-1133
550 GRIZZLY 09-14	0214-1136	0214-1136
660 GRIZZLY 03-08	0214-1121	0214-1122
660 RHINO 06-07	0214-1132	0214-1133
700 GRIZZLY 14-15	0214-1141	0214-1141
700 GRIZZLY 07-13	0214-1136	0214-1136
700 RHINO 08-09, 11-13	-	0214-1135
700 WOLVERINE 16-18	0214-1142	0214-1142
700 VIKING 14-19	0214-1142	0214-1142



CV REBUILD KITS (OUTBOARD & INBOARD)

Improve OEM quality. Includes heavy-duty puncture-resistant boot, cage, race and balls, clamps and grease. Step-by-step instructions included.



FITS MODEL	OUTBOARD PART #	INBOARD PART #
CV REBUILD KITS		
ARCTIC CAT		
375 02 4X4-(FRONT AXLES)	0213-0186	0213-0187
250 (FRONT AXLES) 01 4X4-19 TEETH ON BAR	0213-0186	0213-0187
250 (FRONT AXLES) 02-05 4X4	0213-0186	0213-0187
250 (REAR AXLES) 01 ALL-19 TEETH ON BAR	0213-0186	0213-0187
250 (REAR AXLES) 02-05 ALL	0213-0186	0213-0187
300 (FRONT AXLES) 01 4X4-19 TEETH ON BAR	0213-0186	0213-0187
300 (FRONT AXLES) 02-05 4X4	0213-0186	0213-0187
300 (REAR AXLES) 01 ALL-19 TEETH ON BAR	0213-0186	0213-0187
300 (REAR AXLES) 02-05 ALL	0213-0186	0213-0187
400 (FRONT AXLES) 01 4X4-19 TEETH ON BAR	0213-0186	0213-0187
400 (FRONT AXLES) 02-08 4X4	0213-0186	0213-0187
400 (REAR AXLES) 02-08 ALL	0213-0186	0213-0187
500 (FRONT AXLES) 01 4X4-19 TEETH ON BAR	0213-0186	0213-0187
500 (FRONT AXLES) 02-08 4X4	0213-0186	0213-0187
500 (REAR AXLES) 03-08 ALL	0213-0186	0213-0187
650 (FRONT AXLES) 04-08 4X4	0213-0186	0213-0187
650 (REAR AXLES) 04-08 4X4	0213-0186	0213-0187
700 (FRONT AXLES) 07-08 4X4	0213-0186	0213-0187
700 (REAR AXLES) 07-08 4X4	0213-0186	0213-0187
CAN-AM		
OUTLANDER 330 (FRONT AXLES) 04-05 4X4	-	0213-0326
OUTLANDER 400 (FRONT AXLES) 03-05 4X4	-	0213-0326
OUTLANDER 400 (FRONT AXLES) 07-08 4X4	-	0213-0420
RENEGADE 500 (FRONT AXLES) 08 4X4	-	0213-0420
QUEST 500 02-04 4X4-(FRONT AXLES)	-	0213-0326
TRAXTER 95-05 4X4-(FRONT AXLES)	-	0213-0326
OUTLANDER 500 (FRONT AXLES) 07-08 4X4-	-	0213-0420
OUTLANDER 650 (FRONT AXLES) 07-08 4X4	-	0213-0420
QUEST 650 02-04 4X4-(FRONT AXLES)	-	0213-0326
OUTLANDER 800 (FRONT AXLES) 07-08 4X4	-	0213-0420
RENEGADE 800 (FRONT AXLES) 07-08 4X4	-	0213-0420
COMMANDER 1000 (FRONT AXLES) 11-12 4X4	0213-0664	0213-0420
COMMANDER 800 (FRONT AXLES) 11-12 4X4	0213-0664	0213-0420
COMMANDER 1000 (FRONT AXLES) 15 4X4	0213-0665	0213-0666
COMMANDER 1000 (FRONT AXLES) 13-14 4X4	0213-0669	0213-0670
COMMANDER 1000 (REAR AXLES) 11-12 4X4	0213-0662	0213-0663
COMMANDER 1000 (REAR AXLES) 13-15 4X4	0213-0667	0213-0668
COMMANDER 800 (FRONT AXLES) 15 4X4	0213-0665	0213-0666
COMMANDER 800 (FRONT AXLES) 13-14 4X4	0213-0669	0213-0670
COMMANDER 800 (REAR AXLES) 11-12 4X4	0213-0662	0213-0663
COMMANDER 800 (REAR AXLES) 13-15 4X4	0213-0667	0213-0668
MAVERICK 1000 (FRONT AXLES) 13 4X4	0213-0665	0213-0666
MAVERICK 1000 (REAR AXLES) 13-15 4X4	0213-0667	0213-0668
MAVERICK 1000 (FRONT AXLES) 14-15 4X4-EXC. X MR	0213-0665	0213-0666
MAVERICK 1000 (FRONT AXLES) 14-15 4X4-X MR	0213-0665	0213-0670
OUTLANDER 1000 (REAR AXLES) 12 4X4	0213-0662	-
OUTLANDER 500 (REAR AXLES) 08-12 4X4	0213-0662	-
OUTLANDER 650 (REAR AXLES) 08-12 4X4	0213-0662	-
OUTLANDER 800 (REAR AXLES) 08-12 4X4	0213-0662	-
RENEGADE 1000 (REAR AXLES) 12 4X4	0213-0662	-
RENEGADE 500 (REAR AXLES) 08-12 4X4	0213-0662	-
RENEGADE 800 (REAR AXLES) 08-12 4X4	0213-0662	-
HONDA		
TRX300 FOURTRAX 88-00 4X4	0213-0327	0213-0328
TRX350 RANCHER 86-89 4X4	0213-0327	-
TRX350 RANCHER 00-05 4X4	0213-0327	0213-0189
TRX400 FOREMAN 95-01 4X4	0213-0327	0213-0328
TRX400 FOREMAN 03 4X4	0213-0327	0213-0189
TRX450 FOREMAN 98-04 4X4	0213-0327	0213-0189
TRX500 RUBICON 01-04 4X4	-	0213-0189
TRX650 RINCON (FRONT AXLES) 03-04 4X4	-	0213-0189
KAWASAKI		
BAYOU 300 89-04 4X4	0213-0191	-
PRAIRIE 360 06 4X4	0213-0191	-

FITS MODEL	OUTBOARD PART #	INBOARD PART #
CV REBUILD KITS (CON'T)		
KAWASAKI (CON'T)		
BAYOU 400 93-99 4X4	0213-0191	-
PRAIRIE 400 97-02 4X4	0213-0191	-
BRUTE FORCE 650 05-08 4X4	0213-0191	-
BRUTE FORCE 650I (REAR AXLES) 06-08 4X4	0213-0196	-
PRAIRIE 700 04-06 4X4	0213-0191	-
BRUTE FORCE 750I (REAR AXLES) 05-07 4X4	0213-0196	-
MULE 2510 93-99 4X4-620CC	0213-0191	-
MULE 2510 00-02 4WD- 620CC & 950CC DIESEL	0213-0191	-
MULE 3010 01-08 4WD- 620CC & 950CC DIESEL	0213-0191	-
POLARIS		
250 93 4X4	0213-0199	-
250 93 6X6	0213-0199	-
BIG BOSS 250 91 6X6	0213-0199	-
BIG BOSS 250 92 6X6-W/ USA 0B	0213-0199	-
TRAIL BOSS 250 91 4X4	0213-0199	-
TRAIL BOSS 250 92 4X4-W/ USA 0B	0213-0199	-
XPLORER 250 00-02 4X4	0213-0199	-
300 94 4X4	0213-0199	-
300 94 6X6	0213-0199	-
300 96 4X4	0213-0199	-
HAWKEYE 300 (FRONT AXLES) 06-07 4X4	-	0213-0442
HAWKEYE 300 (REAR AXLES) 06-07 4X4	-	0213-0442
HAWKEYE 300 (REAR AXLES) 06-10 2X4	-	0213-0442
SPORTSMAN 300 (FRONT & REAR AXLES) 08-10 4X4	-	0213-0442
ATP 330 04 4X4	0213-0199	-
ATP 330 05 4X4	0213-0204	-
MAGNUM 330 03-04 4X4-EXC. HDS (VISCO-LOK)	0213-0199	-
MAGNUM 330 05-06 4X4	0213-0204	-
SPORTSMAN 335 (REAR AXLES) 00 4X4-SOME MODELS USE U-JOINTS	-	0213-0201
350L 90 4X4	0213-0199	-
350L 93 4X4	0213-0199	-
350L 93 6X6	0213-0199	-
TRAIL BOSS 350L 1990 1991 4X4	0213-0199	-
TRAIL BOSS 350L 92 4X4-W/ USA 0B	0213-0199	-
400L 94 4X4	0213-0199	-
400L 94 6X6	0213-0199	-
400L 95 6X6-W/ USA 0B	0213-0199	-
SCRAMBLER 400 95-96 4X4-W/ USA 0B	0213-0199	-
SCRAMBLER 400 99 4X4-W/ USA 0B	0213-0199	-
SCRAMBLER 400 00-02 4X4	0213-0199	-
SPORTSMAN 400 (FRONT AXLES) 94 4X4	0213-0199	-
SPORTSMAN 400 (FRONT AXLES) 95-96 4X4-W/ USA 0B	0213-0199	-
SPORTSMAN 400 (REAR AXLES) 01-02 4X4	-	0213-0201
SPORTSMAN 400 (FRONT AXLES) 02-04 4X4	0213-0199	-
SPORTSMAN 400 (REAR AXLES) 03-05 4X4	0213-0202	0213-0201
SPORTSMAN 400 (FRONT AXLES) 05 4X4	0213-0204	-
SPORTSMAN 400 (FRONT AXLES) 08-10 4X4	-	0213-0442
XPLORER 400 95-96 4X4-W/ USA 0B	0213-0199	-
XPLORER 400 99-02 4X4	0213-0199	-
MAGNUM 425 95-96 4X4-W/ USA 0B	0213-0199	-
MAGNUM 425 95-96 6X6-W/ USA 0B	0213-0199	-
XPEDITION 425 02 4X4	0213-0199	-
DIESEL 455 (REAR AXLES) 99-02 4X4	-	0213-0201
ATP 500 H.O. 04 4X4	0213-0199	-
ATP 500 H.O. 05 4X4	0213-0204	-
LUH 500 02 6X6	0213-0199	-
MAGNUM 500 02 2X4-HDS (VISCO-LOK)	0213-0199	-
MAGNUM 500 02 4X4-EXC. HDS (VISCO-LOK)	0213-0199	-
OUTLAW 500 (REAR AXLES) 06-07 2X4-IRS	0213-0204	-
OUTLAW 500 (REAR AXLES) 06-07 2X4- IRS	-	0213-0441
SCRAMBLER 500 99-07 4X4	0213-0199	-
SPORTSMAN 500 (FRONT AXLES) 96 4X4-W/ USA 0B	0213-0199	-
SPORTSMAN 500 (FRONT AXLES) 97 4X4	0213-0199	-
SPORTSMAN 500 (FRONT AXLES) 02-04 4X4	0213-0199	-
SPORTSMAN 500 (FRONT AXLES) 02-04 6X6	0213-0199	-
SPORTSMAN 500 (FRONT AXLES) 05 4X4	0213-0204	-
SPORTSMAN 500 (FRONT AXLES) 05 6X6	0213-0199	-
SPORTSMAN 500 (FRONT AXLES) 06 6X6	0213-0199	-
SPORTSMAN 500 (FRONT AXLES) 07 6X6	0213-0199	-
SPORTSMAN 500 (REAR AXLES) 99-02 4X4	-	0213-0201
SPORTSMAN 500 (REAR AXLES) 03-05 4X4	0213-0202	0213-0201
OUTLAW 525 (REAR AXLES) 07-09 2X4- IRS	-	0213-0441
OUTLAW 525 (REAR AXLES) 07 2X4-IRS	0213-0204	-
SPORTSMAN 600 (FRONT AXLES) 03-04 4X4	0213-0199	-
SPORTSMAN 600 (FRONT AXLES) 05 4X4	0213-0204	-

PLOWS
WINCHES
UTV
RACKS
IMPLEMENT & TOWING
LUGGAGE
BODY
CONTROLS
ELECTRICAL
WHEELS & TIRES
SUSPENSION & DRIVE
BRAKING
ENGINE
RIDER
GARAGE
PROMO

SUSPENSION & DRIVE

FITS MODEL	OUTBOARD PART #	INBOARD PART #
CV REBUILD KITS (CON'T)		
POLARIS (CON'T)		
SPORTSMAN 600 (REAR AXLES) 03-05 4X4	0213-0202	0213-0201
SPORTSMAN 700 (FRONT AXLES) 02-04 4X4	0213-0199	-
SPORTSMAN 700 (FRONT AXLES) 05 4X4	0213-0204	-
SPORTSMAN 700 (REAR AXLES) 02-05 4X4	0213-0202	0213-0201
SPORTSMAN MV7 (FRONT AXLES) 05 4X4	0213-0204	-
SPORTSMAN MV7 (FRONT AXLES) 07 6X6	0213-0199	-
SPORTSMAN MV7 (REAR AXLES) 05 4X4	0213-0202	0213-0201
SPORTSMAN MV7 (REAR AXLES) 06-07 4X4	-	0213-0201
SPORTSMAN 800 (FRONT AXLES) 05 4X4	0213-0204	-
SPORTSMAN 800 (FRONT AXLES) 06 4X4-08		
HOUSING STAMPED *NEAPCO*	0213-0204	-
SPORTSMAN 800 (REAR AXLES) 05 4X4	0213-0202	0213-0201
SPORTSMAN X2 800 (REAR AXLES) 07 4X4	-	0213-0498
SPORTSMAN 1000 (FRONT AXLES) 15 4X4	0213-0673	0213-0577
SCRAMBLER 1000 (FRONT AXLES) 14-15 4X4-XP	0213-0673	0213-0577
SCRAMBLER 850 (FRONT AXLES) 13-15 4X4-(FRONT AXLES)	0213-0673	0213-0577
SPORTSMAN 400 (FRONT AXLES) 13-14 4X4	0213-0673	0213-0674
SPORTSMAN 450 (FRONT AXLES) 16 4X4	0213-0673	0213-0674
SPORTSMAN 500 (FRONT AXLES) 13-14 4X4	0213-0673	0213-0674
SPORTSMAN 550 (FRONT AXLES) 11-14 4X4	0213-0673	0213-0577
SPORTSMAN 570 (FRONT AXLES) 14-16 4X4	0213-0673	0213-0674
SPORTSMAN 800 (FRONT AXLES) 13-14 4X4	0213-0673	0213-0674
SPORTSMAN 800 (FRONT AXLES) 13-14 6X6	0213-0673	0213-0674
SPORTSMAN 800 (FRONT AXLES) 15 6X6	0213-0673	0213-0674
SPORTSMAN 850 (FRONT AXLES) 11-15 4X4	0213-0673	0213-0577
SPORTSMAN ETX (FRONT AXLES) 15 4X4	0213-0673	0213-0674
RANGER (FRONT AXLES) 99-01 SERIES 99	0213-0199	-
RANGER (FRONT AXLES) 02 SERIES 10	0213-0199	-
RANGER (FRONT AXLES) 03-04 SERIES 11	0213-0199	-
RANGER 400 (FRONT AXLES) 10-13	0213-0332	-
RANGER 500 (FRONT AXLES) 04-05 6X6	0213-0199	-
RANGER 500 (FRONT AXLES) 06-07 4X4	0213-0204	-
RANGER 500 (FRONT AXLES) 11-13	0213-0332	-
RANGER 500 (REAR AXLES) 05-06 2X4	0213-0202	-
RANGER 500 (REAR AXLES) 05-06 4X4	0213-0202	-
RANGER 500 (REAR AXLES) 07 2X4	0213-0202	-
RANGER 500 (REAR AXLES) 07 4X4-AFTER 8/26/06	-	-
RANGER 500 (REAR AXLES) 07 4X4-BEFORE 8/26/06	0213-0202	-
RANGER 700 (FRONT AXLES) 06-07 6X6	0213-0204	-
RANGER 700 (MIDDLE AXLES) 06-07 6X6	0213-0202	0213-0201
RANGER 700 (MIDDLE AXLES) 06-07 6X6	-	-
RANGER XP 700 (FRONT AXLES) 06-07 4X4	0213-0204	-
RANGER XP 700 (REAR AXLES) 05-06 4X4	0213-0202	0213-0201
RANGER XP 700 (REAR AXLES) 07 4X4-AFTER 8/26/06	-	0213-0201
RANGER XP 700 (REAR AXLES) 07 4X4-BEFORE 8/26/06	0213-0202	0213-0201
RANGER 800 (MIDDLE AXLES) 11-13 6X6	-	0213-0577
RANGER 800 (REAR AXLES) 11-13 4X4	-	0213-0577
RANGER 800 (REAR AXLES) 11-13 6X6	-	0213-0577
RANGER 900 (FRONT AXLES) 13	0213-0332	-
RANGER 900 (REAR AXLES) 11-13 4X4	0213-0576	0213-0577
GENERAL 1000 (FRONT AXLES) 16 4X4	0213-0332	0213-0675
GENERAL 1000 (REAR AXLES) 16 4X4	0213-0676	0213-0677
RZR 570 (FRONT AXLES) 12-13	0213-0332	-
RZR 800 (FRONT AXLES) 08-13 4X4	0213-0332	-
RZR 800 (REAR AXLES) 11-13 4X4	0213-0576	-
RZR 900 (FRONT AXLES) 11-13 4X4	0213-0576	0213-0577
RZR 900 (REAR AXLES) 11-13 4X4	0213-0576	0213-0577
RZR 1000 (FRONT AXLES) 14-15 4X4-XP	0213-0576	-
RZR 1000 (FRONT AXLES) 15 4X4-XP	0213-0332	0213-0675
RZR 1000 (FRONT AXLES) 16 4X4-S SERIES	0213-0332	0213-0675
RZR 1000 (FRONT AXLES) 16 4X4-XP NON-TURBO (2 SEATER)	0213-0332	0213-0675
RZR 1000 (FRONT AXLES) 16 4X4-XP NON-TURBO (4 SEATER)		
10/19/15 AND BEFORE	0213-0332	0213-0675
RZR 1000 (FRONT AXLES) 16 4X4-XP NON-TURBO (4 SEATER)		
10/20/15 AND AFTER	0213-0678	0213-0679
RZR 1000 (FRONT AXLES) 16 4X4-XP TURBO	0213-0678	0213-0680
RZR 1000 (REAR AXLES) 16 4X4-S SERIES	0213-0676	0213-0677
RZR 1000 (REAR AXLES) 16 4X4-XP NON-TURBO (2 SEATER)	0213-0678	0213-0680
RZR 1000 (REAR AXLES) 16 4X4-XP TURBO	0213-0678	0213-0680
RZR 900 (FRONT AXLES) 15-16 4X4	0213-0332	0213-0675
RZR 900 (REAR AXLES) 15-16 4X4	0213-0676	0213-0677

SUZUKI		
QUAD RUNNER 250 87 4X4-BAR PLUGS DIRECTLY INTO TRANS	0213-0208	-
QUAD RUNNER 250 1988 1996 4X4	0213-0208	0213-0334
QUAD RUNNER 250 97-98 4X4-W/ 68LAC IB	0213-0208	0213-0333

FITS MODEL	OUTBOARD PART #	INBOARD PART #
CV REBUILD KITS (CON'T)		
SUZUKI (CON'T)		
QUAD RUNNER 250 97-98 4X4-W/ 71LAC IB	0213-0208	0213-0334
QUAD RUNNER 250 99-02 4X4	0213-0208	0213-0333
QUAD RUNNER 300 94-95 4X4	0213-0208	0213-0334
KING QUAD 300 91-93 4X4	0213-0208	0213-0334
KING QUAD 300 96-98 4X4-W/ 68LAC IB	0213-0208	0213-0333
KING QUAD 300 96-98 4X4-W/ 71LAC IB	0213-0208	0213-0334
KING QUAD 300 99-02 4X4	0213-0208	0213-0333
EIGER 400 02 4X4	0213-0208	0213-0333
EIGER 400 03-04 4X4-W/ 68LAC 0B	0213-0208	0213-0333
EIGER 400 05-07 4X4	0213-0208	-
QUAD MASTER 500 99-02 4X4	0213-0208	0213-0333
QUAD RUNNER 500 98-02 4X4	0213-0208	0213-0333
VINSON 500 02 4X4-AT	0213-0208	0213-0333
VINSON 500 06 4X4	0213-0208	-
Q.U.V. 620 (UTILITY VEHICLE) 05 4X4	0213-0208	-
KING QUAD 300 99-02 4X4	-	0213-0334
TWIN PEAKS 700 04-05 4X4	0213-0208	-
TERYX 750 (REAR AXLES) 14-15 4X4	0213-0671	0213-0672
TERYX 800 (REAR AXLES) 14-15 4X4	0213-0671	0213-0672
TERYX 750 (REAR AXLES) 12-13 4X4-TERYX4	0213-0671	0213-0672
TERYX 800 (REAR AXLES) 14-15 4X4	0213-0671	0213-0672
YAMAHA		
TIMBERWOLF 250 94-00 4X4	0213-0212	0213-0213
BIG BEAR 350 87-96 4X4	0213-0212	0213-0213
BIG BEAR 350 97 4X4-IB HOUSING STAMPED *68 AC*	0213-0212	0213-0213
BIG BEAR 350 97 4X4-IB HOUSING STAMPED *68 LAC*	0213-0212	-
BIG BEAR 350 98-99 4X4	0213-0212	-
BIG BEAR 400 (FRONT AXLES) 00-01 4X4-EXC. IRS	0213-0212	-
BIG BEAR 400 (FRONT AXLES) 02-06 4X4-EXC. IRS	0213-0212	0213-0213
BIG BEAR 400 (FRONT AXLES) 07-08 4X4-W/ IRS	-	0213-0217
BIG BEAR 400 (REAR AXLES) 07-08 4X4-W/ IRS	0213-0212	-
BRUIN 350 04-06 4X4	0213-0212	0213-0213
GRIZZLY 350 (FRONT AXLES) 07-08 4X4-EXC. IRS	0213-0212	0213-0213
GRIZZLY 350 (FRONT AXLES) 07-08 4X4-W/ IRS	-	0213-0217
GRIZZLY 350 (REAR AXLES) 07-08 4X4-W/ IRS	0213-0212	-
WOLVERINE 350 95-05 4X4	0213-0212	-
GRIZZLY 400 (FRONT AXLES) 07 4X4	0213-0212	0213-0213
GRIZZLY 400 (REAR AXLES) 07 4X4	0213-0212	-
KODIAK 400 (FRONT AXLES) 93-98 4X4	0213-0212	0213-0213
KODIAK 400 (FRONT AXLES) 99 4X4	0213-0212	-
KODIAK 400 (FRONT AXLES) 00-06 4X4	0213-0212	0213-0213
KODIAK 400 (REAR AXLES) 05-06 4X4	0213-0212	-
GRIZZLY 450 (FRONT AXLES) 07 4X4	0213-0212	-
GRIZZLY 450 (FRONT AXLES) 08 4X4	-	0213-0217
GRIZZLY 450 (REAR AXLES) 07-08 4X4	0213-0212	-
KODIAK 450 (FRONT AXLES) 03-06 4X4	0213-0212	-
KODIAK 450 (REAR AXLES) 05-06 4X4-(REAR AXLES)	0213-0212	-
RHINO 450 (FRONT AXLES) 06 4X4	0213-0218	0213-0215
RHINO 450 (REAR AXLES) 06 4X4	0213-0218	0213-0215
WOLVERINE 450 SPORT 06-08 4X4	0213-0212	0213-0213
GRIZZLY 550 (FRONT AXLES) 09-14 4X4-(FRONT AXLES)	0213-0580	-
GRIZZLY 550 (REAR AXLES) 09-14 4X4-(REAR AXLES)	0213-0580	-
GRIZZLY 600 98-01 4X4	-	0213-0215
GRIZZLY 660 (FRONT AXLES) 02 4X4	0213-0212	-
GRIZZLY 660 (FRONT AXLES) 03 4X4-0B HOUSING STAMPED *68 LAC*	0213-0212	0213-0217
GRIZZLY 660 (FRONT AXLES) 03 4X4-0B HOUSING STAMPED *UJ 68*	-	0213-0217
GRIZZLY 660 (FRONT AXLES) 04-08 4X4	0213-0212	0213-0217
GRIZZLY 660 (REAR AXLES) 03 4X4	-	-
GRIZZLY 660 (REAR AXLES) 04-08 4X4	0213-0212	-
GRIZZLY 700 (FRONT AXLES) 09-14 4X4-(FRONT AXLES)	0213-0580	-
GRIZZLY 700 (REAR AXLES) 09-14 4X4-(REAR AXLES)	0213-0580	-
RHINO 660 (FRONT AXLES) 04 4X4	0213-0212	0213-0217
RHINO 660 (FRONT AXLES) 05-07 4X4	0213-0218	0213-0217
RHINO 660 (REAR AXLES) 04 4X4	0213-0212	-
RHINO 660 (REAR AXLES) 05-06 4X4	0213-0218	0213-0215
RHINO 660 (REAR AXLES) 07 4X4	0213-0218	-
RHINO 700 (FRONT AXLES) 08 4X4	0213-0218	-
RHINO 700 (REAR AXLES) 08 4X4	0213-0218	-
RHINO 700 (REAR AXLES) 08-09 4X4	-	0213-0446



OUTBOARD/INBOARD CV JOINT KITS

Heavy-duty fully assembled joint and boot. Comes with heavy-duty puncture resistant boot, clamps and grease. Made in the USA.



FITS MODEL	OUTBOARD PART #	INBOARD PART #
OUTBOARD/INBOARD CV JOINT KITS		
ARCTIC CAT-FRONTS		
250 05 4X4	0213-0179	0213-0478
250 02-04 4X4	0213-0156	0213-0478
250 01 4X4-INNER RACE W/ 18 TEETH	0213-0299	-
250 01 4X4-INNER RACE W/ 19 TEETH	0213-0156	-
300 05 4X4	0213-0179	0213-0478
300 02-04 4X4	0213-0156	0213-0478
300 01 4X4-INNER RACE W/ 18 TEETH	0213-0299	-
300 01 4X4-INNER RACE W/ 19 TEETH	0213-0156	-
300 98-00 4X4	0213-0299	-
375 02 4X4	0213-0156	0213-0478
400 06-08 4X4-EXC. FIS	0213-0300	-
400 06-08 4X4-FIS-LEFT SIDE-MACHINES WITH FULLY-INDEPENDENT SUSPENSION	0213-0300	-
400 06-08 4X4-FIS-RIGHT SIDE-MACHINES WITH FULLY-INDEPENDENT SUSPENSION	0213-0300	-
400 05 4X4-EXC. FIS	0213-0179	0213-0478
400 05 4X4-FIS-LEFT SIDE-MACHINES WITH FULLY-INDEPENDENT SUSPENSION	0213-0179	-
400 05 4X4-FIS-RIGHT SIDE-MACHINES WITH FULLY-INDEPENDENT SUSPENSION	0213-0179	0213-0478
400 02-04 4X4	0213-0156	0213-0478
400 01 4X4-INNER RACE W/ 18 TEETH	0213-0299	-
400 01 4X4-INNER RACE W/ 19 TEETH	0213-0156	-
400 98-00 4X4	0213-0299	-
454 98 4X4-FROM #13001	0213-0299	-
500 07-08 4X4-LEFT SIDE	0213-0300	-
500 07-08 4X4-RIGHT SIDE	0213-0300	-
500 06 4X4-FIS-LEFT SIDE-MACHINES WITH FULLY-INDEPENDENT SUSPENSION	0213-0300	-
500 06 4X4-FIS-RIGHT SIDE-MACHINES WITH FULLY-INDEPENDENT SUSPENSION	0213-0300	-
500 06 4X4-TBX-LEFT SIDE	0213-0300	-
500 06 4X4-TBX-RIGHT SIDE	0213-0300	-
500 06 4X4-TRV	0213-0300	-
500 05 4X4-FIS-LEFT SIDE-MACHINES WITH FULLY-INDEPENDENT SUSPENSION	0213-0179	-
500 05 4X4-FIS-RIGHT SIDE-MACHINES WITH FULLY-INDEPENDENT SUSPENSION	0213-0179	0213-0478
500 02-04 4X4	0213-0156	0213-0478
500 01 4X4-INNER RACE W/ 18 TEETH	0213-0299	-
500 01 4X4-INNER RACE W/ 19 TEETH	0213-0156	-
500 98-00 4X4	0213-0299	-
650 06-08 4X4-LEFT SIDE-EXC. PROWLER XT	0213-0300	-
650 06-08 4X4-LEFT SIDE-PROWLER XT	0213-0300	-
650 06-08 4X4-RIGHT SIDE-EXC. PROWLER XT	0213-0300	-
650 06-08 4X4-RIGHT SIDE-PROWLER XT	0213-0300	-
650 05 4X4-LEFT SIDE	0213-0179	-
650 05 4X4-RIGHT SIDE	0213-0179	0213-0478
650 04 4X4-LEFT SIDE	0213-0156	-
650 04 4X4-RIGHT SIDE	0213-0156	0213-0478
700 07-08 4X4-LEFT SIDE	0213-0300	-
700 07-08 4X4-RIGHT SIDE	0213-0300	-
CAN-AM-FRONTS		
OUTLANDER 330 04-05 4X4	0213-0304	-
OUTLANDER 400 06-08 4X4	0213-0307	-
OUTLANDER 400 03-05 4X4	0213-0304	-
OUTLANDER 500 07-08 4X4	0213-0307	-
OUTLANDER 650 06-08 4X4	0213-0307	-
OUTLANDER 800 06-08 4X4	0213-0307	-
QUEST 500 02-04 4X4	0213-0306	-
QUEST 650 02-04 4X4	0213-0306	-
RENEGADE 500 08 4X4	0213-0307	-
RENEGADE 800 07-08 4X4	0213-0307	-
TRAXTER 500 02-05 4X4	0213-0306	-
TRAXTER 500 01 4X4-7459/7460/7467/7468/7472/7481	0213-0306	-
TRAXTER 500 01 4X4-EXC. AUTOSHIFT 7431/7432	0213-0306	-
TRAXTER 500 01 4X4-FOOTSHIFT 7473/7474	0213-0306	-
TRAXTER 500 01 4X4-XL 7448-FROM SERIAL NO. V000709	0213-0306	-
TRAXTER 500 01 4X4-XL 7467/7468/7472/7481/7489	0213-0306	-

PLOWS

WINCHES

UTV

RACKS

IMPLEMENTS & TOWING

LUGGAGE

BODY

CONTROLS

ELECTRICAL

WHEELS & TIRES

SUSPENSION & DRIVE

BRAKING

ENGINE

RIDER

GARAGE

PROMO

SUSPENSION & DRIVE

FITS MODEL	OUTBOARD PART #	INBOARD PART #
OUTBOARD/INBOARD CV JOINT KITS (CON'T)		
HONDA-FRONTS		
TRX300 FOURTRAX 88-00 4X4	0213-0046	-
TRX350 FOURTRAX 87 4X4	0213-0046	-
TRX350 RANCHER 06 4X4	0213-0096	-
TRX350 RANCHER 00-05 4X4	0213-0096	-
TRX350D FOREMAN 87-89 4X4	0213-0046	-
TRX400 FOREMAN 95-03 4X4	0213-0046	-
TRX400 RANCHER 04-07 4X4	0213-0096	-
TRX400 RANCHER 95-03 4X4	0213-0046	-
TRX420 RANCHER 09 4X4-EXC. AT W/ POWER STEERING	0213-0399	-
TRX420 RANCHER 07-08 4X4	0213-0399	-
TRX450 FOREMAN 98-04 4X4	0213-0046	0213-0466
TRX500 FOREMAN 08-09 4X4	0213-0399	-
TRX500 FOREMAN 07 4X4-ES W/ POWER STEERING ES-ELECTRONIC SHIFT PROGRAM	0213-0399	-
TRX500 FOREMAN 07 4X4-EXC. ES W/ POWER STEERING ES-ELECTRONIC SHIFT PROGRAM	0213-0095	-
TRX500 FOREMAN 2005 2006 4X4	0213-0095	-
TRX500 RUBICON 2008 2009 4X4	0213-0399	-
TRX500 RUBICON 2005 2007 4X4	0213-0095	-
TRX500 RUBICON 01-04 4X4	0213-0095	0213-0466
TRX650 RINCON 05 4X4	0213-0095	-
TRX650 RINCON 03-04 4X4	0213-0095	-
TRX680 RINCON 08-09 4X4	0213-0399	-
TRX680 RINCON 06-07 4X4	0213-0095	-
JOHN DEERE-FRONTS		
BUCK 04-06 4X4	0213-0306	-
KAWASAKI-FRONTS		
BAYOU 300 89-04 4X4	0213-0050	-
PRAIRIE 400 97-02 4X4	0213-0050	-
BAYOU 400 93-99 4X4	0213-0050	-
BRUTE FORCE 650I 06-09 4X4-LEFT SIDE	0213-0302	-
BRUTE FORCE 650I 06-09 4X4-RIGHT SIDE	0213-0302	-
BRUTE FORCE 750I 08-10 4X4-LEFT SIDE	0213-0374	-
BRUTE FORCE 750I 08-10 4X4-RIGHT SIDE	0213-0374	-
BRUTE FORCE 750I 05-07 4X4-LEFT SIDE	0213-0302	-
BRUTE FORCE 750I 05-07 4X4-RIGHT SIDE	0213-0302	-
MULE 2510 00-02 4WD-620CC & 950CC DIESEL	0213-0183	-
MULE 2510 93-99 4WD-620CC & 950CC DIESEL	0213-0183	-
MULE 3010 01-08 4WD-620CC & 950CC DIESEL	0213-0183	-
POLARIS-FRONTS		
SPORTSMAN 550 11-14 4X4	0213-0638	0213-0592
SPORTSMAN 570 14 4X4	0213-0640	0213-0642
SPORTSMAN 800 11-12 4X4	0213-0639	0213-0592
SPORTSMAN 800 13-14 4X4	0213-0640	0213-0642
SCRAMBLER 850 13-14 4X4	0213-0638	0213-0592
SPORTSMAN 850 11-14 4X4	0213-0638	0213-0592
SCRAMBLER 1000 14 4X4	0213-0638	0213-0592
250 93 4X4	0213-0287	-
250 93 6X6	0213-0287	-
BIG BOSS 250 92 6X6-W/ USA OB	0213-0287	-
TRAIL BOSS 250 91 4X4	0213-0287	-
TRAIL BOSS 250 92 4X4-W/ USA OB	0213-0287	-
XPLORER 250 00-02 4X4	0213-0049	-
300 94 4X4/6X6	0213-0287	-
300 96 4X4	0213-0287	-
HAWKEYE 300 06-07 4X4	0213-0294	0213-0470
SPORTSMAN 300 08-10 4X4	0213-0294	0213-0470
XPLORER 300 97 4X4-FROM 1/1/97	0213-0047	-
XPLORER 300 98-99 4X4	0213-0047	-
MAGNUM 325 00 4X4	0213-0047	-
MAGNUM 325 01-02 4X4-EXC. HDS (VISCO-LOK)	0213-0047	-
MAGNUM 325 01-02 4X4-HDS (VISCO-LOK)-LEFT SIDE	0213-0291	-
MAGNUM 325 01-02 4X4-HDS (VISCO-LOK)-RIGHT SIDE	0213-0291	-
XPEDITION 325 00-02 4X4	0213-0047	-
MAGNUM 330 03 4X4-EXC. HDS (VISCO-LOK)	0213-0180	-
MAGNUM 330 03 4X4-HDS (VISCO-LOK)-LEFT SIDE	0213-0291	-
MAGNUM 330 03 4X4-HDS (VISCO-LOK)-RIGHT SIDE	0213-0291	-
MAGNUM 330 04 4X4-EXC. HDS (VISCO-LOK)	0213-0180	-
MAGNUM 330 05-06 4X4	0213-0258	-
SPORTSMAN 335 99-00 4X4	0213-0047	-
350L 93 4X4/6X6	0213-0287	-
TRAIL BOSS 350 92 4X4-W/ USA OB	0213-0287	-
400L 94 4X4/6X6	0213-0287	-
400L 95 6X6-W/ USA OB	0213-0287	-
BIG BOSS 400L 97 6X6-FROM 1/1/97	0213-0047	-

FITS MODEL	OUTBOARD PART #	INBOARD PART #
OUTBOARD/INBOARD CV JOINT KITS (CON'T)		
POLARIS-FRONTS (CON'T)		
SCRAMBLER 400 98 4X4	0213-0047	-
SCRAMBLER 400 99 4X4-W/ BTB OB	0213-0047	-
SCRAMBLER 400 99 4X4-W/ USA OB	0213-0049	-
SCRAMBLER 400 00-02 4X4	0213-0049	-
SPORTSMAN 400 94 4X4	0213-0287	-
SPORTSMAN 400 97 4X4	0213-0047	-
SPORTSMAN 400 01 4X4	0213-0047	-
SPORTSMAN 400 02-03 4X4	0213-0049	-
SPORTSMAN 400 04 4X4-W/ FEMALE SPLINE ON IB YOKE	0213-0049	-
SPORTSMAN 400 04 4X4-W/ MALE SPLINE ON IB YOKE	0213-0180	-
SPORTSMAN 400 05 4X4	0213-0258	-
SPORTSMAN 400 08-10 4X4	0213-0294	0213-0470
SPORTSMAN 400 11-12 4X4	0213-0639	0213-0592
SPORTSMAN 400 13-14 4X4	0213-0640	0213-0642
XPLORER 400 97 4X4-FROM 1/1/97	0213-0047	-
XPLORER 400 98 4X4	0213-0047	-
XPLORER 400 99-02 4X4	0213-0049	-
MAGNUM 425 97 4X4-FROM 1/1/97	0213-0047	-
MAGNUM 425 97 6X6-FROM 1/1/97	0213-0047	-
MAGNUM 425 98 4X4	0213-0047	-
XPEDITION 425 00-01 4X4	0213-0047	-
XPEDITION 425 02 4X4	0213-0049	-
SPORTSMAN 450 07 4X4-AFTER 7/25/06	0213-0257	0213-0471
ATP 500 H.O. 04 4X4	0213-0180	-
ATP 500 H.O. 05 4X4	0213-0258	-
BIG BOSS 500 98-99 6X6	0213-0047	-
MAGNUM 500 99-00 4X4	0213-0047	-
MAGNUM 500 01 4X4-EXC. HDS (VISCO-LOK)	0213-0047	-
MAGNUM 500 01 4X4-HDS (VISCO-LOK)-LEFT SIDE	0213-0291	-
MAGNUM 500 01 4X4-HDS (VISCO-LOK)-RIGHT SIDE	0213-0291	-
MAGNUM 500 02 4X4-EXC. HDS (VISCO-LOK)	0213-0155	-
MAGNUM 500 02 4X4-HDS (VISCO-LOK)-LEFT SIDE	0213-0291	-
MAGNUM 500 02 4X4-HDS (VISCO-LOK)-RIGHT SIDE	0213-0291	-
SCRAMBLER 500 97 4X4-FROM 1/1/97	0213-0047	-
SCRAMBLER 500 98 4X4	0213-0047	-
SCRAMBLER 500 99-09 4X4	0213-0049	-
SCRAMBLER 500 10 4X4	0213-0257	0213-0471
SCRAMBLER 500 11-12 4X4	0213-0639	0213-0592
SPORTSMAN 500 97 4X4	0213-0049	-
SPORTSMAN 500 98-99 4X4	0213-0047	-
SPORTSMAN 500 00-01 4X4	0213-0047	-
SPORTSMAN 500 00-01 6X6	0213-0047	-
SPORTSMAN 500 02-03 4X4	0213-0049	-
SPORTSMAN 500 02-03 6X6	0213-0049	-
SPORTSMAN 500 04 4X4-W/ FEMALE SPLINE ON IB YOKE	0213-0049	-
SPORTSMAN 500 04 4X4-W/ MALE SPLINE ON IB YOKE	0213-0180	-
SPORTSMAN 500 04 6X6	0213-0049	-
SPORTSMAN 500 05 4X4	0213-0258	-
SPORTSMAN 500 05 6X6	0213-0049	-
SPORTSMAN 500 06 6X6	0213-0049	-
SPORTSMAN 500 07 4X4-AFTER 7/25/06	0213-0257	0213-0471
SPORTSMAN 500 07 6X6	0213-0049	-
SPORTSMAN 500 08 4X4	0213-0257	0213-0471
SPORTSMAN 500 08 6X6	0213-0049	-
SPORTSMAN 500 11-12 4X4	0213-0639	0213-0592
SPORTSMAN 500 13-14 4X4	0213-0640	0213-0642
SPORTSMAN 500 09-10 4X4	0213-0257	0213-0471
SPORTSMAN X2 500 06-07 4X4-AFTER 7/25/06	0213-0257	0213-0471
SPORTSMAN X2 500 08-09 4X4	0213-0257	0213-0471
XPLORER 500 97 4X4	0213-0049	-
SPORTSMAN X2 550 10 4X4	0213-0432	0213-0473
SPORTSMAN XP 550 09-10 4X4	0213-0432	0213-0473
SPORTSMAN 600 03-04 4X4	0213-0180	-
SPORTSMAN 600 05 4X4	0213-0258	-
SPORTSMAN 700 02 4X4-FROM 5/1/02	0213-0180	-
SPORTSMAN 700 02 4X4-TO 5/1/02	0213-0155	-
SPORTSMAN 700 03-04 4X4	0213-0180	-
SPORTSMAN 700 05 4X4	0213-0258	-
SPORTSMAN 700 07 4X4-AFTER 7/25/06	0213-0257	0213-0471
SPORTSMAN 800 05 4X4	0213-0258	-
SPORTSMAN 800 06 4X4-OB HOUSING STAMPED *NEAPCO*	0213-0258	-
SPORTSMAN 800 07 4X4-AFTER 7/25/06	0213-0257	0213-0471
SPORTSMAN 800 08-10 4X4	0213-0257	0213-0471
SPORTSMAN X2 800 07 4X4-AFTER 7/25/06	0213-0257	0213-0471
SPORTSMAN X2 800 08-09 4X4	0213-0257	0213-0471

FITS MODEL	OUTBOARD PART #	INBOARD PART #
OUTBOARD/INBOARD CV JOINT KITS (CON'T)		
POLARIS-FRONTS (CON'T)		
SPORTSMAN XP 850 09-10 4X4	0213-0432	0213-0473
RANGER 03-04 4X4-SERIES 11	0213-0155	-
RANGER 03-04 6X6-SERIES 11	0213-0155	-
RANGER 02 4X4-SERIES 10	0213-0155	-
RANGER 02 6X6-SERIES 10	0213-0155	-
RANGER 500 05 4X4	0213-0291	-
RANGER 500 04-05 6X6	0213-0155	-
RANGER 500 06-07 4X4	0213-0256	-
RANGER 500 08 4X4	0213-0433	-
RANGER 500 09-10 4X4	0213-0434	0213-0471
RANGER 700 06-07 6X6	0213-0256	-
RANGER 700 08-09 4X4	0213-0434	-
RANGER 700 08-09 6X6	0213-0433	0213-0471
RANGER 700 (MIDDLE AXLES) 06-07 6X6	0213-0053	-
RANGER 700 (MIDDLE AXLES) 08 6X6	0213-0436	-
RANGER XP 700 05 4X4	0213-0291	-
RANGER XP 700 06-07 4X4	0213-0256	-
RANGER XP 700 08 4X4	0213-0433	-
RANGER XP 700 09 4X4	0213-0434	0213-0471
RANGER 800 10 4X4	0213-0434	0213-0471
RANGER 800 10 6X6	0213-0434	0213-0471
RANGER 800 (MIDDLE AXLES) 11-13 6X6	0213-0590	-
RANGER 800 11-13 4X4/6X6	-	0213-0594
RANGER 900 11-12 4X4	-	0213-0599
RANGER 900 13 4X4-DIESEL	-	0213-0599
RZR 08-10 4X4	0213-0296	0213-0402
RZR S "SPORT" 09-10 4X4	0213-0296	0213-0402
RZR 900 11-13 4X4	0213-0589	0213-0592
RZR 1000 (FRONT AXLES) 15 4X4-XP	0213-0296	0213-0402
RZR 1000 (FRONT AXLES) 14 4X4-XP	0213-0589	0213-0592
POLARIS-MIDDLES		
SPORTSMAN 800 11-14 6X6	0213-0590	0213-0641
SUZUKI-FRONTS		
QUAD RUNNER 250 87-02 4X4	0213-0181	-
KING QUAD 300 91-02 4X4	0213-0181	-
QUAD RUNNER 300 94-95 4X4	0213-0181	-
EIGER 400 02 4X4	0213-0181	-
EIGER 400 03-04 4X4-W/ 68LAC OB	0213-0181	-
EIGER 400 03-04 4X4-W/ WJ68 OB	0213-0286	-
EIGER 400 05-07 4X4	0213-0181	-
EIGER 400 03-04 4X4-W/ WJ68 OB	0213-0286	-
EIGER 400 05-07 4X4	0213-0181	-
KING QUAD 450 07-10 4X4	0213-0584	-
QUAD RUNNER 500 98-01 4X4	0213-0181	-
QUAD MASTER 500 00-01 4X4	0213-0181	-
KING QUAD 500 09-10 4X4	0213-0584	-
KING QUAD 500 11-12 4X4-EXC. POWER STEERING	0213-0584	-
KING QUAD 500 11-12 4X4-W/ POWER STEERING	0213-0584	-
VINSON 500 02 4X4-AT	0213-0181	-
VINSON 500 03-05 4X4	0213-0286	-
VINSON 500 06 4X4-AT	0213-0181	-
VINSON 500 03-05 4X4	0213-0286	-
VINSON 500 06-07 4X4	0213-0181	-
KING QUAD 700 05 4X4	0213-0284	-
KING QUAD 750 08 4X4	0213-0584	-
KING QUAD 750 09-12 4X4-EXC. POWER STEERING	0213-0584	-
KING QUAD 750 09-12 4X4-W/ POWER STEERING	0213-0584	-
YAMAHA-FRONTS		
TIMBERWOLF 250 94-00 4X4	0213-0048	0213-0396
BIG BEAR 350 87-88 4X4	-	0213-0396
BIG BEAR 350 89-96 4X4	0213-0048	0213-0396
BIG BEAR 350 97 4X4-W/ 68 AC IB INBOARD CV JOINT HAS NUMBERS STAMPED INTO THE BELL TO HELP IDENTIFY THE APPLICATION	0213-0048	0213-0396
BIG BEAR 350 97 4X4-W/ 68 LAC IB INBOARD CV JOINT HAS NUMBERS STAMPED INTO THE BELL TO HELP IDENTIFY THE APPLICATION	0213-0048	-
BIG BEAR 350 98-99 4X4	0213-0048	-
BIG BEAR 400 00-01 4X4	0213-0048	-
BIG BEAR 400 02-06 4X4	0213-0048	0213-0398
BIG BEAR 400 07-08 4X4-W/ IRS	-	0213-0260
BRUIN 350 04-06 4X4	0213-0099	0213-0398
GRIZZLY 350 07-08 4X4-EXC. IRS	0213-0099	0213-0398
GRIZZLY 350 07-08 4X4-W/ IRS	-	0213-0260
WOLVERINE 350 95-00 4X4	0213-0048	-
WOLVERINE 350 01-05 4X4	0213-0099	-
KODIAK 400 93-98 4X4	0213-0048	0213-0396

FITS MODEL	OUTBOARD PART #	INBOARD PART #
OUTBOARD/INBOARD CV JOINT KITS (CON'T)		
YAMAHA-FRONTS (CON'T)		
KODIAK 400 99 4X4	0213-0048	-
KODIAK 400 00-06 4X4	0213-0099	0213-0398
GRIZZLY 400 07 4X4	0213-0099	0213-0398
GRIZZLY 450 07 4X4-LEFT SIDE	0213-0099	-
GRIZZLY 450 07 4X4-RIGHT SIDE	0213-0099	-
GRIZZLY 450 08 4X4	-	0213-0260
KODIAK 450 03-06 4X4-LEFT SIDE	0213-0099	-
KODIAK 450 03-06 4X4-RIGHT SIDE	0213-0099	-
WOLVERINE 450 SPORT 06 4X4	0213-0099	0213-0398
GRIZZLY 600 99-01 4X4	0213-0274	-
GRIZZLY 660 02 4X4-LEFT SIDE	0213-0099	-
GRIZZLY 660 02 4X4-RIGHT SIDE	0213-0099	-
GRIZZLY 660 03 4X4-W/ 68LAC OB-LEFT SIDE	0213-0098	-
GRIZZLY 660 03 4X4-W/ 68LAC OB-RIGHT SIDE	0213-0098	0213-0260
GRIZZLY 660 03 4X4-W/ WJ68 OB-LEFT SIDE	0213-0154	-
GRIZZLY 660 03 4X4-W/ WJ68 OB-RIGHT SIDE	0213-0154	0213-0260
GRIZZLY 660 04-08 4X4-LEFT SIDE	0213-0098	-
GRIZZLY 660 04-08 4X4-RIGHT SIDE	0213-0098	0213-0260
GRIZZLY 700 07-08 4X4	0213-0278	0213-0393
RHINO 450 06-07 4X4-LEFT SIDE	0213-0255	0213-0260
RHINO 450 06-07 4X4-RIGHT SIDE	0213-0255	-
RHINO 660 06-07 4X4-LEFT SIDE	0213-0255	0213-0260
RHINO 660 06-07 4X4-RIGHT SIDE	0213-0255	-
RHINO 660 05 4X4-LEFT SIDE	0213-0277	0213-0260
RHINO 660 05 4X4-RIGHT SIDE	0213-0277	-
RHINO 660 04 4X4-LEFT SIDE	-	0213-0260
RHINO 700 SE 08-09 4X4	0213-0255	0213-0393
ARCTIC CAT-REARS		
250 99-00 2X4	0213-0299	-
250 01 2X4-INNER RACE W/ 18 TEETH	0213-0299	-
250 01 2X4-INNER RACE W/ 19 TEETH	0213-0156	-
250 01 4X4-INNER RACE W/ 18 TEETH	0213-0299	-
250 01 4X4-INNER RACE W/ 19 TEETH-	0213-0156	-
250 02-04 2X4/4X4	0213-0156	-
250 05 2X4/4X4	0213-0179	-
300 98-00 2X4/4X4	0213-0299	-
300 01 2X4-INNER RACE W/ 18 TEETH	0213-0299	-
300 01 2X4-INNER RACE W/ 19 TEETH	0213-0156	-
300 01 4X4-INNER RACE W/ 18 TEETH	0213-0299	-
300 01 4X4-INNER RACE W/ 19 TEETH	0213-0156	-
300 02 2X4/4X4	0213-0156	-
300 03-04 4X4	0213-0156	-
300 05 4X4	0213-0179	-
400 02-04 2X4/4X4	0213-0156	0213-0478
400 05 4X4	0213-0179	-
400 06-08 4X4	0213-0300	-
500 03-04 4X4	0213-0156	0213-0478
500 05 4X4	0213-0179	-
500 06-08 4X4	0213-0300	-
650 04-05 4X4	0213-0179	-
650 06-08 4X4	0213-0300	-
700 07-08 4X4	0213-0300	-
CAN-AM-REARS		
OUTLANDER 330 04-05 ALL	0213-0308	-
OUTLANDER 400 03-08 ALL	0213-0308	-
HONDA-REARS		
TRX650 RINCON 03-05 4X4	0213-0283	-
TRX680 RINCON 06-10 4X4	0213-0283	-
KAWASAKI-REARS		
BRUTE FORCE 650I 09 4X4	0213-0373	-
BRUTE FORCE 750I 08-10 4X4	0213-0373	-
POLARIS-REARS		
HAWKEYE 300 06-07 4X4	0213-0294	0213-0470
HAWKEYE 300 06-10 2X4	0213-0294	0213-0470
SPORTSMAN 300 08-10 4X4	0213-0294	0213-0470
SPORTSMAN 335 00 4X4-SOME APPLICATIONS USE U-JOINTS	0213-0051	0213-0184
SPORTSMAN 400 01-02 4X4	0213-0051	0213-0184
SPORTSMAN 400 03-05 4X4	0213-0053	0213-0184
SPORTSMAN 400 08-10 4X4	0213-0294	0213-0470
HAWKEYE 400 11-14	0213-0590	0213-0641
SPORTSMAN 450 06-07 4X4	0213-0293	0213-0184
SPORTSMAN 500 99-02 4X4	0213-0051	0213-0184
SPORTSMAN 500 03-05 4X4	0213-0053	0213-0184
SPORTSMAN 500 06-07 4X4	0213-0293	0213-0184
SPORTSMAN 500 08-10 4X4-EXC. TOURING	0213-0436	0213-0453

SUSPENSION & DRIVE

FITS MODEL	OUTBOARD PART #	INBOARD PART #
OUTBOARD/INBOARD CV JOINT KITS (CON'T)		
POLARIS-REARS (CON'T)		
SPORTSMAN 500 08-10 4X4-TOURING-(REAR AXLES)	0213-0436	0213-0448
SPORTSMAN X2 500 06-07 4X4	0213-0293	-
SPORTSMAN X2 500 08-09 4X4	0213-0436	0213-0448
OUTLAW 500 06-07 2X4-IRS	0213-0295	-
OUTLAW 525 07-09 2X4-IRS	0213-0295	-
SPORTSMAN X2 550 10 4X4	0213-0439	-
SPORTSMAN XP 550 09 4X4	0213-0437	0213-0448
SPORTSMAN XP 550 10 4X4-EPS	0213-0439	-
SPORTSMAN XP 550 10 4X4-EXC. EPS	0213-0437	0213-0448
SPORTSMAN 600 03-05 4X4	0213-0053	0213-0184
SPORTSMAN 700 02 4X4	0213-0290	0213-0184
SPORTSMAN 700 03-05 4X4	0213-0053	0213-0184
SPORTSMAN 700 06-07 4X4	0213-0293	0213-0184
SPORTSMAN 800 05 4X4	0213-0053	0213-0184
SPORTSMAN 800 06-07 4X4	0213-0293	0213-0184
SPORTSMAN 800 08-09 4X4-EXC. TOURING	0213-0436	0213-0453
SPORTSMAN 800 08-09 4X4-TOURING	0213-0436	0213-0448
SPORTSMAN 800 10 4X4	0213-0436	0213-0453
SPORTSMAN X2 800 07 4X4	0213-0293	-
SPORTSMAN X2 800 08-09 4X4	0213-0436	0213-0448
SPORTSMAN XP 850 09 4X4	0213-0437	0213-0448
SPORTSMAN XP 850 10 4X4-EXC. TOURING	0213-0437	0213-0448
SPORTSMAN XP 850 10 4X4-TOURING	0213-0439	-
RANGER 500 05-06 2X4-LEFT SIDE	0213-0053	0213-0400
RANGER 500 05-06 2X4-RIGHT SIDE	0213-0053	-
RANGER 500 05-06 4X4-LEFT SIDE	0213-0053	0213-0400
RANGER 500 05-06 4X4-RIGHT SIDE	0213-0053	-
RANGER 500 07 2X4-LEFT SIDE	0213-0053	0213-0400
RANGER 500 07 2X4-RIGHT SIDE	0213-0053	-
RANGER 500 07 4X4-AFTER 8/26/06-LEFT SIDE	0213-0293	0213-0400
RANGER 500 07 4X4-AFTER 8/26/06-RIGHT SIDE	0213-0293	-
RANGER 500 07 4X4-BEFORE 8/26/06-LEFT SIDE	0213-0053	0213-0400
RANGER 500 07 4X4-BEFORE 8/26/06-RIGHT SIDE	0213-0053	-
RANGER 500 08 2X4-LEFT SIDE	0213-0436	-
RANGER 500 08 2X4-RIGHT SIDE	0213-0436	-
RANGER 500 08 4X4-LEFT SIDE	0213-0436	-
RANGER 500 08 4X4-RIGHT SIDE	0213-0436	-
RANGER 700 08 4X4-LEFT SIDE	0213-0436	-
RANGER 700 08 4X4-RIGHT SIDE	0213-0436	-
RANGER XP 700 05-06 4X4-LEFT SIDE	0213-0053	0213-0400
RANGER XP 700 05-06 4X4-RIGHT SIDE	0213-0053	-
RANGER XP 700 07 4X4-AFTER 8/26/06-LEFT SIDE	0213-0293	0213-0400
RANGER XP 700 07 4X4-AFTER 8/26/06-RIGHT SIDE	0213-0293	-
RANGER XP 700 07 4X4-BEFORE 8/26/06-LEFT SIDE	0213-0053	0213-0400
RANGER XP 700 07 4X4-BEFORE 8/26/06-RIGHT SIDE	0213-0053	-
RANGER XP 700 08 4X4-LEFT SIDE	0213-0436	-
RANGER XP 700 08 4X4-RIGHT SIDE	0213-0436	-
RANGER 800 11-13 4X4	0213-0590	0213-0593
RANGER 800 11-13 6X6-LEFT SIDE	0213-0590	-
RANGER 800 11-13 6X6-RIGHT SIDE	0213-0590	-
RANGER 900 11-12 4X4-LEFT SIDE	0213-0590	-
RANGER 900 11-12 4X4-RIGHT SIDE	0213-0590	-
RANGER 900 13 4X4-XP	0213-0590	0213-0593
RANGER 900 13 4X4-DIESEL-LEFT SIDE	0213-0590	-
RANGER 900 13 4X4-DIESEL-RIGHT SIDE	0213-0590	-
RZR 800 08-10 4X4	0213-0297	0213-0403
RZR 800 11-12 4X4-4 SEATER INTL.-LEFT SIDE	0213-0590	-
RZR 800 11-12 4X4-4 SEATER INTL.-RIGHT SIDE	0213-0590	-
RZR 800 11-12 4X4-EXC. S SERIES INTL. & 4 SEATER INTL.	0213-0590	-
RZR 800 11-12 4X4-S SERIES INTL-LEFT SIDE	0213-0590	-
RZR 800 11-12 4X4-S SERIES INTL-RIGHT SIDE	0213-0590	-
RZR 800 13 4X4	0213-0590	-
RZR 900 11-13 4X4	0213-0590	-
RZR 900 11-13 4X4	-	0213-0593
HAWKEYE 400 11-14 2X4	0213-0590	0213-0641
SPORTSMAN 400 11-14 4X4	0213-0590	0213-0641
SPORTSMAN 500 11-13 4X4-EXC. TOURING	0213-0590	0213-0641
SPORTSMAN 500 14 4X4	0213-0590	0213-0641
SPORTSMAN 570 14 4X4	0213-0590	0213-0641
SPORTSMAN 800 11-14 4X4	0213-0590	0213-0641
SPORTSMAN 800 11-14 6X6	0213-0590	0213-0641
RZR 1000 14-15 4X4-XP	0213-0637	-
SUZUKI-REARS		
KING QUAD 450 07-10 4X4	0213-0583	0213-0585
KING QUAD 500 09-12 4X4	0213-0583	0213-0585

FITS MODEL	OUTBOARD PART #	INBOARD PART #
OUTBOARD/INBOARD CV JOINT KITS (CON'T)		
SUZUKI-REARS (CON'T)		
KING QUAD 700 07 4X4-HOUSING HAS INNER RACE W/ 26 TEETH	0213-0583	0213-0585
KING QUAD 750 08-12 4X4	0213-0583	0213-0585
YAMAHA-REARS		
GRIZZLY 350 07-08 4X4-W/ IRS	0213-0276	0213-0395
BIG BEAR 400 07-08 4X4-W/ IRS	0213-0276	0213-0395
GRIZZLY 400 07 4X4	0213-0276	0213-0395
KODIAK 400 05-06 4X4	0213-0276	0213-0395
KODIAK 450 05-06 4X4	0213-0276	0213-0395
GRIZZLY 450 07-08 4X4	0213-0276	0213-0395
GRIZZLY 660 02 4X4-LEFT SIDE	0213-0275	0213-0281
GRIZZLY 660 02 4X4-RIGHT SIDE	0213-0275	0213-0261
GRIZZLY 660 03 4X4-LEFT SIDE	0213-0154	0213-0182
GRIZZLY 660 03 4X4-RIGHT SIDE	0213-0154	0213-0185
GRIZZLY 660 04-08 4X4-LEFT SIDE	0213-0098	0213-0182
GRIZZLY 660 04-08 4X4-RIGHT SIDE	0213-0098	0213-0185
GRIZZLY 700 07-08 4X4	0213-0278	0213-0394
RHINO 450 06 4X4-LEFT SIDE	0213-0255	0213-0261
RHINO 450 06 4X4-RIGHT SIDE	0213-0255	0213-0281
RHINO 660 04 4X4-LEFT SIDE	-	0213-0185
RHINO 660 04 4X4-RIGHT SIDE	-	0213-0182
RHINO 660 05 4X4-LEFT SIDE	0213-0277	0213-0261
RHINO 660 05 4X4-RIGHT SIDE	0213-0277	0213-0281
RHINO 660 06 4X4-LEFT SIDE	0213-0255	0213-0261
RHINO 660 06 4X4-RIGHT SIDE	0213-0255	0213-0281
RHINO 660 07 4X4-LEFT SIDE	0213-0255	-
RHINO 660 07 4X4-RIGHT SIDE	0213-0255	-
RHINO 700 SE 08-09 4X4-LEFT SIDE	0213-0255	-
RHINO 700 SE 08-09 4X4-RIGHT SIDE	0213-0255	-
GRIZZLY 450 11-14 4X4	0213-0632	0213-0394
RHINO 450 07-09 4X4-RIGHTSIDE	0213-0255	0213-0633
RHINO 450 07-09 4X4-LEFTSIDE	0213-0255	0213-0634
RHINO 660 07 4X4-RIGHTSIDE	0213-0255	0213-0633
RHINO 660 07 4X4-LEFTSIDE	0213-0255	0213-0634
RHINO 700 08-13 4X4-RIGHTSIDE	0213-0255	0213-0633
RHINO 700 08-13 4X4-LEFTSIDE	0213-0255	0213-0634



CV BOOT KITS

Replace those dangerously worn, inexpensive CV boots before dirt, dust and grime destroy expensive CV joints. Tougher than stock and complete with everything you need to complete the job. Heavy-duty puncture resistant boot. Comes with grease and clamps. Each complete assembly fits one side. Sold each. Made in the USA.



FITS MODEL CV BOOT KITS	OUTBOARD PART #	INBOARD PART #
ARCTIC CAT		
250 (FRONT AXLES) 01-05 4X4	0213-0159	0213-0044
250 (REAR AXLES) 99-00 2X4	0213-0159	0213-0044
250 (REAR AXLES) 01-05 2X4	0213-0159	0213-0044
250 (REAR AXLES) 01-05 4X4	0213-0159	0213-0044
300 (FRONT AXLES) 98-08 4X4	0213-0159	0213-0044
300 (REAR AXLES) 98-02 2X4	0213-0159	0213-0044
300 (REAR AXLES) 98-02 4X4	0213-0159	0213-0044
300 (REAR AXLES) 03-05 4X4	0213-0159	0213-0044
375 02 4X4-(FRONT AXLES)	0213-0159	0213-0044
400 (FRONT AXLES) 98-08 4X4	0213-0159	0213-0044
400 (REAR AXLES) 03-05 2X4	0213-0159	0213-0044
400 (REAR AXLES) 03-05 4X4	0213-0159	0213-0044
400 (REAR AXLES) 06-08 4X4	0213-0159	0213-0044
454 96-97 4X4-(FRONT AXLES)	0213-0039	0213-0044
454 98 4X4-BELOW SERIAL #13000	0213-0039	0213-0044
454 98 4X4-FROM SERIAL #13000	0213-0159	0213-0044
500 (FRONT AXLES) 98-08 4X4	0213-0159	0213-0044
500 (REAR AXLES) 03-08 4X4	0213-0159	0213-0044
650 (FRONT AXLES) 04-08 4X4	0213-0159	0213-0044
650 (REAR AXLES) 04-08 4X4	0213-0159	0213-0044
700 (FRONT AXLES) 07-08 4X4	0213-0159	0213-0044
700 (REAR AXLES) 07-08 4X4	0213-0159	0213-0044
WILDCAT 1000 (FRONT AXLES) 12-16 4X4	0213-0661	0213-0661
WILDCAT 1000 (REAR AXLES) 12-16 4X4	0213-0661	0213-0661
CAN-AM		
OUTLANDER 330 (FRONT AXLES) 04-05 4X4	0213-0321	0213-0412
OUTLANDER 330 (REAR AXLES) 04-05 ALL	-	0213-0414
OUTLANDER 400 (FRONT AXLES) 03-05 4X4	0213-0321	0213-0412
OUTLANDER 400 (FRONT AXLES) 06-08 4X4	0213-0322	0213-0323
OUTLANDER 400 (REAR AXLES) 03-08 ALL	0213-0413	0213-0414
OUTLANDER 400 09-12 ALL-(REAR AXLES)	0213-0322	0213-0611
OUTLANDER 500 (FRONT AXLES) 07-08 4X4	0213-0322	0213-0323
OUTLANDER 500 (REAR AXLES) 07 4X4	0213-0324	0213-0324
OUTLANDER 500 13-15 4X4-(REAR AXLES)	0213-0609	0213-0609
RENEGADE 500 13-15 4X4-(REAR AXLES)	0213-0609	0213-0609
QUEST 500 02-04 4X4-(FRONT AXLES)	0213-0321	0213-0412
RENEGADE 500 (FRONT AXLES) 08 4X4	0213-0322	0213-0323
TRAXTER 500 99-05 4X4-(FRONT AXLES)	0213-0321	0213-0412
OUTLANDER 650 (FRONT AXLES) 06-08 4X4	0213-0322	0213-0323
OUTLANDER 650 (REAR AXLES) 06-07 4X4	0213-0324	0213-0324
QUEST 650 02-04 4X4-(FRONT AXLES)	0213-0321	0213-0412
OUTLANDER 650 13-15 4X4-(REAR AXLES)	0213-0609	0213-0609
OUTLANDER 800 (FRONT AXLES) 06-08 4X4	0213-0322	0213-0323
OUTLANDER 800 (REAR AXLES) 06-07 4X4	0213-0324	0213-0324
RENEGADE 800 (FRONT AXLES) 07-08 4X4	0213-0322	0213-0323
RENEGADE 800 (REAR AXLES) 07 4X4	0213-0324	0213-0324
OUTLANDER 800 15 4X4-EXC. X MR (MUD RIDING SPECIALIST)-(REAR AXLES)	0213-0609	0213-0609
RENEGADE 800 13-15 4X4-(REAR AXLES)	0213-0609	0213-0609
OUTLANDER 1000 13 4X4-(REAR AXLES)	0213-0609	0213-0609
OUTLANDER 1000 14 6X6-(REAR AXLES)	0213-0609	0213-0609
OUTLANDER 1000 14 4X4-(REAR AXLES)	0213-0609	0213-0609
OUTLANDER 1000 15 4X4-EXC. X MR (MUD RIDING SPECIALIST)-(REAR AXLES)	0213-0609	0213-0609
OUTLANDER 1000 15 6X6-(REAR AXLES)	0213-0609	0213-0609
RENEGADE 1000 13-15 4X4-(REAR AXLES)	0213-0609	0213-0609
COMMANDER 800 11-15 4X4-(REAR AXLES)	0213-0608	0213-0608
COMMANDER 800 14-15 4X4-(REAR AXLES)	0213-0609	0213-0609
COMMANDER 800 13 4X4-EXC. SUPPLEMENT-IS MARKET-(REAR AXLES)	0213-0609	0213-0609
COMMANDER 800 13-15 4X4 (FRONT AXLES)	0213-0610	0213-0322
COMMANDER 1000 11-12 4X4-(REAR AXLES)	0213-0608	0213-0608
COMMANDER 1000 14-15 4X4-(REAR AXLES)	0213-0609	0213-0609
COMMANDER 1000 13 4X4-EXC. SUPPLEMENT-IS MARKET-(REAR AXLES)	0213-0609	0213-0609

FITS MODEL CV BOOT KITS (CON'T)	OUTBOARD PART #	INBOARD PART #
CAN-AM (CON'T)		
COMMANDER 1000 13-15 4X4 (FRONT AXLES)	0213-0610	0213-0322
MAVERICK 1000 14-15 4X4-(FRONT AXLES)	0213-0322	0213-0323
MAVERICK 1000 13-15 4X4-(REAR AXLES)	0213-0609	0213-0609
HONDA		
TRX300 FOURTRAX 88-00 4X4	0213-0039	0213-0041
TRX350 RANCHER 86-89 4X4	0213-0039	-
TRX350 RANCHER 00-03 4X4	0213-0039	0213-0042
TRX400 FOREMAN 95-01 4X4	0213-0039	0213-0041
TRX400 FOREMAN 03 4X4	0213-0039	0213-0042
TRX420 RANCHER ES 07-08 4X4	0213-0039	0213-0311
TRX450 FOREMAN 98-04 4X4	0213-0039	0213-0042
TRX500 FOREMAN 07 4X4-ES W/ POWER STEERING	0213-0039	0213-0311
TRX500 FOREMAN 07 4X4-EXC. ES W/ POWER STEERING	0213-0157	0213-0311
TRX500 FOREMAN 08 4X4	0213-0039	0213-0311
TRX500 RUBICON 01-04 4X4	0213-0157	0213-0042
TRX500 RUBICON 05-07 4X4	0213-0157	0213-0311
TRX500 RUBICON 08 4X4	0213-0039	0213-0311
TRX650 RINCON (FRONT AXLES) 03-04 4X4	0213-0157	0213-0042
TRX650 RINCON (FRONT AXLES) 05 4X4	0213-0157	0213-0311
TRX650 RINCON (REAR AXLES) 03-05 4X4	0213-0158	0213-0251
TRX680 RINCON (FRONT AXLES) 06-07 4X4	0213-0157	0213-0311
TRX680 RINCON (FRONT AXLES) 08 4X4	0213-0039	0213-0311
TRX680 RINCON (REAR AXLES) 06-08 4X4	0213-0158	0213-0251
KAWASAKI		
BAYOU 300 89-04 4X4	0213-0039	0213-0042
PRAIRIE 300 99-02 4X4	0213-0039	0213-0041
PRAIRIE 360 03-05 4X4	0213-0039	0213-0041
PRAIRIE 360 06-08 4X4	0213-0039	0213-0160
PRAIRIE 360 09-10 4X4	0213-0411	-
BAYOU 400 93-99 4X4	0213-0039	0213-0042
PRAIRIE 400 97-02 4X4	0213-0039	0213-0041
BRUTE FORCE 650 04-08 4X4	0213-0039	0213-0160
BRUTE FORCE 650I (FRONT AXLES) 06-08 4X4	0213-0252	0213-0160
BRUTE FORCE 650I (REAR AXLES) 06-08 4X4	0213-0252	0213-0319
BRUTE FORCE 650I (FRONT AXLES) 09 4X4	0213-0408	-
BRUTE FORCE 650I (REAR AXLES) 09 4X4	0213-0407	-
BRUTE FORCE 650 10 4X4	0213-0411	-
PRAIRIE 650 02-03 4X4	0213-0039	0213-0041
PRAIRIE 700 04-06 4X4	0213-0039	0213-0160
BRUTE FORCE 750I (FRONT AXLES) 05-07 4X4	0213-0252	0213-0160
BRUTE FORCE 750I (REAR AXLES) 05-07 4X4	0213-0252	0213-0319
BRUTE FORCE 750I (FRONT AXLES) 08-10 4X4	0213-0408	-
BRUTE FORCE 750I (REAR AXLES) 08-10 4X4	0213-0407	-
MULE 610 05-07 4WD-400CC	0213-0252	0213-0041
MULE 610 10 4WD-400CC	0213-0408	-
MULE 2010 90 4WD-540CC	0213-0039	-
MULE 2510 93-99 4WD-620CC	0213-0039	-
MULE 2510 00-02 4WD-620CC & 950CC DIESEL	0213-0039	0213-0042
MULE 3010 01-08 4WD-620CC & 950CC DIESEL	0213-0039	0213-0042
MULE 4010 09-10 4WD-620CC & 950CC DIESEL	0213-0411	-
TERYX 750 (FRONT AXLES) 09 4X4-FROM SERIAL # 98500713	0213-0407	-
TERYX 750 (REAR AXLES) 08-09 4X4	-	0213-0410
TERYX 750 (REAR AXLES) 08-09 4X4	0213-0430	-
TERYX 750 12-13 4X4-TERYX4 (4 SEATER)-(FRONT AXLES)	0213-0604	0213-0605
TERYX 750 12-13 4X4-TERYX4 (4 SEATER)-(REAR AXLES)	0213-0606	0213-0607
TERYX 750 14 4X4-EXC. TERYX4-(FRONT AXLES)	0213-0604	-
TERYX 750 14 4X4-TERYX4 (4 SEATER)-(FRONT AXLES)	0213-0604	-
TERYX 750 14 4X4-(REAR AXLES)	0213-0606	0213-0607
KYMCO		
MXU 500 06-07 4X4	0213-0039	0213-0041
POLARIS		
250 93 4X4	0213-0100	-
250 93 6X6	0213-0100	-
BIG BOSS 250 91 6X6	0213-0040	-
BIG BOSS 250 92 6X6-W/ BTB 0B	0213-0040	-
BIG BOSS 250 92 6X6-W/ USA 0B	0213-0100	-
TRAIL BOSS 250 91 4X4	0213-0040	-
TRAIL BOSS 250 92 4X4-W/ BTB 0B	0213-0040	-
TRAIL BOSS 250 92 4X4-W/ USA 0B	0213-0100	-
XPLORER 250 00-02 4X4	0213-0100	-
300 94 4X4	0213-0100	-
300 94 6X6	0213-0100	-
300 95 4X4	0213-0040	-
300 96 4X4	0213-0100	-
HAWKEYE 300 (FRONT AXLES) 06-07 4X4	0213-0039	0213-0041

PLOWS
WINCHES
UTV
RACKS
IMPLEMENT & TOWING
LUGGAGE
BODY
CONTROLS
ELECTRICAL
WHEELS & TIRES
SUSPENSION & DRIVE
BRAKING
ENGINE
RIDER
GARAGE
PROMO

SUSPENSION & DRIVE

FITS MODEL	OUTBOARD PART #	INBOARD PART #
CV BOOT KITS (CON'T)		
POLARIS (CON'T)		
HAWKEYE 300 (REAR AXLES) 06-07 2X4	0213-0039	0213-0041
HAWKEYE 300 (REAR AXLES) 06-07 4X4	0213-0039	0213-0041
XPLORER 300 96-99 4X4	0213-0040	-
MAGNUM 325 00 4X4	0213-0040	-
MAGNUM 325 01-02 4X4-EXC. HDS (VISCO-LOK)	0213-0040	-
MAGNUM 325 01-02 4X4-HDS (VISCO-LOK)	0213-0040	-
XPEDITION 325 00-02 4X4	0213-0040	-
ATP 330 04 4X4	0213-0100	-
ATP 330 05 4X4	0213-0100	0213-0312
MAGNUM 330 03-04 4X4-EXC. HDS (VISCO-LOK)	0213-0100	-
MAGNUM 330 03-04 4X4-HDS (VISCO-LOK)	0213-0040	-
MAGNUM 330 05-06 4X4	0213-0100	0213-0312
SPORTSMAN 335 (FRONT AXLES) 99-00 4X4	0213-0040	-
SPORTSMAN 335 (REAR AXLES) 00 4X4 SOME MODELS USE U-JOINTS	0213-0045	0213-0043
WORKER 335 99 4X4	0213-0040	-
350L 90 4X4	0213-0040	-
350L 93 4X4	0213-0100	-
350L 93 6X6	0213-0100	-
TRAIL BOSS 350L 91 4X4	0213-0040	-
TRAIL BOSS 350L 92 4X4-W/ BTB OB	0213-0040	-
TRAIL BOSS 350L 92 4X4-W/ USA OB	0213-0100	-
400L 94 4X4	0213-0100	-
400L 94 6X6	0213-0100	-
400L 95-96 6X6-W/ BTB OB	0213-0040	-
400L 95-96 6X6-W/ USA OB	0213-0100	-
BIG BOSS 400L 97 6X6	0213-0040	-
SCRAMBLER 400 95-96 4X4-W/ BTB OB	0213-0040	-
SCRAMBLER 400 95-96 4X4-W/ USA OB	0213-0100	-
SCRAMBLER 400 97-98 4X4	0213-0040	-
SCRAMBLER 400 99 4X4-W/ BTB OB	0213-0040	-
SCRAMBLER 400 99 4X4-W/ USA IB	0213-0100	-
SCRAMBLER 400 00-02 4X4	0213-0100	-
SPORTSMAN 400 (FRONT AXLES) 94 4X4	0213-0100	-
SPORTSMAN 400 (FRONT AXLES) 95-96 4X4-W/ BTB OB	0213-0040	-
SPORTSMAN 400 (FRONT AXLES) 95-96 4X4-W/ USA OB	0213-0100	-
SPORTSMAN 400 (FRONT AXLES) 97 4X4	0213-0040	-
SPORTSMAN 400 (FRONT AXLES) 01 4X4	0213-0040	-
SPORTSMAN 400 (FRONT AXLES) 02-04 4X4	0213-0100	-
SPORTSMAN 400 (FRONT AXLES) 05 4X4	0213-0100	0213-0312
SPORTSMAN 400 (REAR AXLES) 01-02 4X4	0213-0045	0213-0043
SPORTSMAN 400 (REAR AXLES) 03-05 4X4	0213-0178	0213-0043
SPORTSMAN 400 13-14 4X4-(FRONT AXLES)	0213-0602	0213-0602
XPLORER 400 95-96 4X4-W/ BTB OB	0213-0040	-
XPLORER 400 95-96 4X4-W/ USA OB	0213-0100	-
XPLORER 400 97-98 4X4	0213-0040	-
XPLORER 400 99-02 4X4	0213-0100	-
MAGNUM 425 95-96 4X4-W/ BTB OB	0213-0040	-
MAGNUM 425 95-96 4X4-W/ USA OB	0213-0100	-
MAGNUM 425 95-96 6X6-W/ BTB OB	0213-0040	-
MAGNUM 425 95-96 6X6-W/ USA OB	0213-0100	-
MAGNUM 425 97-98 4X4	0213-0040	-
MAGNUM 425 97-98 6X6	0213-0040	-
XPEDITION 425 00-01 4X4	0213-0040	-
XPEDITION 425 02 4X4	0213-0100	-
SPORTSMAN 450 (FRONT SHAFT) 06-07 4X4-AFTER 7/25/06	0213-0316	0213-0317
SPORTSMAN 450 (FRONT SHAFT) 06-07 4X4-BEFORE 7/25/06	0213-0040	0213-0318
SPORTSMAN 450 (REAR AXLES) 06-07 4X4	0213-0313	0213-0314
DIESEL 455 (FRONT AXLES) 99-02 4X4	0213-0040	-
DIESEL 455 (REAR AXLES) 00-02 4X4	0213-0045	0213-0043
ATP 500 H.O. 04 4X4	0213-0100	-
ATP 500 H.O. 05 4X4	0213-0100	0213-0312
ATV PRO 500 02 4X4-PPS	0213-0040	-
BIG BOSS 500 98 6X6	0213-0040	-
LUH 500 02 6X6	0213-0100	-
XPLORER 500 97 4X4	0213-0100	-
MAGNUM 500 99-00 4X4	0213-0040	-
MAGNUM 500 01 4X4-EXC. HDS (VISCO-LOK)	0213-0040	-
MAGNUM 500 02 2X4-HDS (VISCO-LOK)	0213-0100	-
MAGNUM 500 02 4X4-EXC. HDS (VISCO-LOK)	0213-0100	-
MAGNUM 500 02 4X4-HDS (VISCO-LOK)	0213-0040	-
MAGNUM 500 03 4X4	0213-0040	-
OUTLAW 500 (REAR AXLES) 06-07 2X4-IRS	0213-0100	-
SCRAMBLER 500 97-98 4X4	0213-0040	-
SCRAMBLER 500 99-07 4X4	0213-0100	-
SPORTSMAN 500 (FRONT AXLES) 96 4X4-W/ BTB OB	0213-0040	-

FITS MODEL	OUTBOARD PART #	INBOARD PART #
CV BOOT KITS (CON'T)		
POLARIS (CON'T)		
SPORTSMAN 500 (FRONT AXLES) 96 4X4-W/ USA OB	0213-0100	-
SPORTSMAN 500 (FRONT AXLES) 97 4X4	0213-0100	-
SPORTSMAN 500 (FRONT AXLES) 98-99 4X4	0213-0040	-
SPORTSMAN 500 (FRONT AXLES) 00-01 4X4	0213-0040	-
SPORTSMAN 500 (FRONT AXLES) 00-01 6X6	0213-0040	-
SPORTSMAN 500 (FRONT AXLES) 02-04 4X4	0213-0100	-
SPORTSMAN 500 (FRONT AXLES) 02-04 6X6	0213-0100	-
SPORTSMAN 500 (FRONT AXLES) 05 4X4	0213-0100	0213-0312
SPORTSMAN 500 (FRONT AXLES) 05 6X6	0213-0100	-
SPORTSMAN 500 (FRONT AXLES) 06 4X4	0213-0040	0213-0318
SPORTSMAN 500 (FRONT AXLES) 06 6X6	0213-0100	-
SPORTSMAN 500 (FRONT AXLES) 07 4X4-AFTER 7/25/06	0213-0316	0213-0317
SPORTSMAN 500 (FRONT AXLES) 07 4X4-BEFORE 7/25/06	0213-0040	0213-0318
SPORTSMAN 500 (FRONT AXLES) 07 6X6	0213-0100	-
SPORTSMAN 500 13-14 4X4-(FRONT AXLES)	0213-0602	0213-0602
SPORTSMAN 500 (REAR AXLES) 99-02 4X4	0213-0045	0213-0043
SPORTSMAN 500 (REAR AXLES) 03-05 4X4	0213-0178	0213-0043
SPORTSMAN 500 (REAR AXLES) 06-07 4X4	0213-0313	0213-0314
SPORTSMAN 500 (REAR AXLES) 08-10 4X4	0213-0426	0213-0429
SPORTSMAN X2 500 (FRONT AXLES) 07 4X4-AFTER 7/25/06	0213-0316	0213-0317
SPORTSMAN X2 500 (FRONT AXLES) 07 4X4-BEFORE 7/25/06	0213-0040	0213-0318
SPORTSMAN X2 500 (REAR AXLES) 07 4X4	0213-0313	0213-0314
SPORTSMAN X2 500 (REAR AXLES) 08-10 4X4	0213-0426	0213-0429
SPORTSMAN XP 550 (REAR AXLES) 09 4X4	0213-0426	0213-0429
SPORTSMAN XP 550 (REAR AXLES) 10 4X4-EXC. EPS	0213-0426	0213-0429
SPORTSMAN X2 550 (REAR AXLES) 10 4X4	0213-0464	-
SPORTSMAN XP 550 (REAR AXLES) 10 4X4-EPS W/ ELECTRONIC POWER STEERING	0213-0464	-
SPORTSMAN 550 11-14 4X4-(FRONT AXLES)	0213-0602	0213-0463
SPORTSMAN 570 14 4X4-(FRONT AXLES)	0213-0602	0213-0602
SPORTSMAN 600 (FRONT AXLES) 03-04 4X4	0213-0100	-
SPORTSMAN 600 (FRONT AXLES) 05 4X4	0213-0100	0213-0312
SPORTSMAN 600 (REAR AXLES) 03-05 4X4	0213-0178	0213-0043
SPORTSMAN 700 (FRONT AXLES) 02-04 4X4	0213-0100	-
SPORTSMAN 700 (FRONT AXLES) 05 4X4	0213-0100	0213-0312
SPORTSMAN 700 (FRONT AXLES) 06-07 4X4-AFTER 7/25/06	0213-0316	0213-0317
SPORTSMAN 700 (FRONT AXLES) 06-07 4X4-BEFORE 7/25/06	0213-0040	0213-0318
SPORTSMAN 700 (REAR AXLES) 02-05 4X4	0213-0178	0213-0043
SPORTSMAN 700 (REAR AXLES) 06-07 4X4	0213-0313	0213-0314
SPORTSMAN 800 (FRONT AXLES) 05 4X4	0213-0100	0213-0312
SPORTSMAN 800 (FRONT AXLES) 06 4X4-OB HOUSING STAMPED *GKN*	0213-0040	0213-0318
SPORTSMAN 800 (FRONT AXLES) 06 4X4-OB HOUSING STAMPED *NEAPCO*	0213-0100	0213-0312
SPORTSMAN 800 (FRONT AXLES) 07 4X4-AFTER 7/25/06	0213-0316	0213-0317
SPORTSMAN 800 (FRONT AXLES) 07 4X4-BEFORE 7/25/06	0213-0040	0213-0318
SPORTSMAN 800 13-14 4X4-(FRONT AXLES)	0213-0602	0213-0602
SPORTSMAN 800 13-14 6X6-(FRONT AXLES)	0213-0602	0213-0602
SPORTSMAN 800 (REAR AXLES) 05 4X4	0213-0178	0213-0314
SPORTSMAN 800 (REAR AXLES) 06-07 4X4	0213-0313	0213-0314
SPORTSMAN 800 (REAR AXLES) 08-10 4X4	0213-0426	0213-0429
SPORTSMAN X2 800 (REAR AXLES) 08-10 4X4	0213-0426	0213-0429
SPORTSMAN X2 800 (FRONT AXLES) 07 4X4-AFTER 7/25/06	0213-0316	0213-0317
SPORTSMAN X2 800 (FRONT AXLES) 07 4X4-BEFORE 7/25/06	0213-0040	0213-0318
SPORTSMAN X2 800 (REAR AXLES) 07 4X4	0213-0313	0213-0314
SPORTSMAN XP 850 (REAR AXLES) 09-10 4X4	0213-0426	0213-0429
SPORTSMAN 850 (REAR AXLES) 10 4X4	0213-0464	-
SPORTSMAN 850 11-14 4X4-(FRONT AXLES)	0213-0602	0213-0463
SCRAMBLER 850 13-14 4X4-(FRONT AXLES)	0213-0602	0213-0463
SCRAMBLER 1000 14 4X4-(FRONT AXLES)	0213-0602	0213-0463
RANGER 400 (FRONT AXLES) 10 4X4	0213-0406	-
RANGER 500 (FRONT AXLES) 05 4X4	0213-0040	0213-0318
RANGER 500 (FRONT AXLES) 04-05 6X6	0213-0100	-
RANGER 500 (FRONT AXLES) 06-07 4X4	0213-0100	0213-0312
RANGER 500 (FRONT AXLES) 08 4X4	0213-0406	-
RANGER 500 (REAR AXLES) 05-07 2X4	0213-0313	0213-0314
RANGER 500 (REAR AXLES) 05-07 4X4	0213-0313	0213-0314
RANGER 500 (REAR AXLES) 08-10 2X4	0213-0426	0213-0429
RANGER 500 (REAR AXLES) 08-10 4X4	0213-0426	0213-0429
RANGER 700 (FRONT AXLES) 06-07 6X6	0213-0100	0213-0312
RANGER 700 (MIDDLE AXLES) 06 6X6	0213-0313	0213-0314
RANGER XP 700 (FRONT AXLES) 05 4X4	0213-0040	0213-0318
RANGER XP 700 (FRONT AXLES) 06-07 4X4	0213-0100	0213-0312
RANGER XP 700 (REAR AXLES) 05-07 4X4	0213-0313	0213-0314
RANGER 700 (FRONT AXLES) 08-09 4X4	0213-0406	-

FITS MODEL	OUTBOARD PART #	INBOARD PART #
CV BOOT KITS (CON'T)		
POLARIS (CON'T)		
RANGER 700 (FRONT AXLES) 08-09 6X6	0213-0406	-
RANGER 700 (MIDDLE AXLES) 08-09 6X6	0213-0426	0213-0429
RANGER 700 (REAR AXLES) 08-09 4X4	0213-0426	0213-0429
RANGER XP 700 (FRONT AXLES) 08 4X4	0213-0406	-
RANGER XP 700 (REAR AXLES) 08-09 4X4	0213-0426	0213-0429
RANGER 800 (REAR AXLES) 10 4X4	0213-0426	0213-0429
RANGER 800 (MIDDLE AXLES) 10 6X6	0213-0426	0213-0429
RANGER 800 (REAR AXLES) 10 6X6	0213-0426	0213-0429
RANGER 800 (MIDDLE AXLES) 11-13 6X6	0213-0558	-
RANGER 800 (REAR AXLES) 11-13 6X6	0213-0558	-
RANGER 800 (REAR AXLES) 11-13 4X4	0213-0558	-
RANGER 99-01 4X4-SERIES 99	0213-0100	-
RANGER 02 4X4-SERIES 10	0213-0100	-
RANGER 03-04 4X4-SERIES 11	0213-0100	-
RZR 800 (FRONT AXLES) 08 4X4	-	0213-0312
RZR 800 (REAR AXLES) 08 4X4	0213-0316	0213-0463
RZR 800 (REAR AXLES) 11-13 4X4	0213-0558	-
RZR (FRONT AXLES) 08-10 4X4	0213-0406	-
RZR S "SPORT" (FRONT AXLES) 09-10 4X4	0213-0406	-
RZR S "SPORT" (REAR AXLES) 09-10 4X4	0213-0426	0213-0429
RZR (REAR AXLES) 08-10 4X4	-	0213-0463
RZR 900 (FRONT AXLES) 11-13 4X4	0213-0558	-
RZR 900 (REAR AXLES) 11-13 4X4	0213-0558	-
RZR 900 (REAR AXLES) 15-16 4X4	0213-0558	0213-0659
RZR 1000 (REAR AXLES) 14-15 4X4-XP-(REAR AXLES)	0213-0313	0213-0314
RZR 1000 (FRONT AXLES) 15 4X4-XP-(FRONT AXLES)	0213-0406	0213-0312
RZR 1000 (REAR AXLES) 16 4X4-S SERIES	0213-0558	0213-0659
RZR 1000 (REAR AXLES) 16 4X4-XP NON-TURBO (2 SEATER)	0213-0313	0213-0660
RZR 1000 (REAR AXLES) 16 4X4-XP NON-TURBO (4 SEATER)	0213-0313	0213-0314
RZR 1000 (REAR AXLES) 16 4X4-XP TURBO	0213-0313	0213-0660
RZR 1000 (FRONT AXLES) 16 4X4-XP TURBO	0213-0313	0213-0660
RZR 1000 (FRONT AXLES) 16 4X4-S SERIES	0213-0406	0213-0312
RZR 1000 (FRONT AXLES) 16 4X4-XP NON-TURBO (2 SEATER)	0213-0406	0213-0312
RZR 1000 (FRONT AXLES) 16 4X4-XP NON-TURBO (4 SEATER)	0213-0406	0213-0312
10/19/15 AND BEFORE	0213-0406	0213-0312
RZR 1000 (FRONT AXLES) 16 4X4-XP NON-TURBO (4 SEATER)	0213-0406	0213-0312
10/20/15 AND AFTER	0213-0313	0213-0312
GENERAL 1000 (REAR AXLES) 16 4X4	0213-0558	0213-0659
SUZUKI		
QUAD RUNNER 250 87 4X4	0213-0041	-
QUAD RUNNER 250 88-96 4X4	0213-0039	0213-0251
QUAD RUNNER 250 97-98 4X4-W/ 68LAC IB	0213-0039	0213-0041
QUAD RUNNER 250 97-98 4X4-W/ 71LAC IB	0213-0039	0213-0251
QUAD RUNNER 250 99-02 4X4	0213-0039	0213-0041
KING QUAD 300 91-93 4X4	0213-0039	0213-0251
KING QUAD 300 96-98 4X4-W/ 68LAC IB	0213-0039	0213-0041
KING QUAD 300 96-98 4X4-W/ 71LAC IB	0213-0039	0213-0251
KING QUAD 300 99-02 4X4	0213-0039	0213-0041
QUAD RUNNER 300 94-95 4X4	0213-0039	0213-0251
EIGER 400 02 4X4	0213-0039	0213-0041
EIGER 400 03-04 4X4-W/ 68LAC OB	0213-0039	0213-0041
EIGER 400 03-04 4X4-W/ WJ68 OB	0213-0310	0213-0250
EIGER 400 05-07 4X4	0213-0039	0213-0160
QUAD MASTER 500 00-01 4X4	0213-0039	0213-0041
QUAD RUNNER 500 98-01 4X4	0213-0039	0213-0041
VINSON 500 02 4X4-AT	0213-0039	0213-0041
VINSON 500 03-05 4X4	0213-0310	0213-0250
VINSON 500 06 4X4-AT	0213-0039	0213-0160
KING QUAD 500 (REAR AXLES) 09-10 4X4	0213-0556	0213-0557
KING QUAD 500 (FRONT AXLES) 11-12 4X4-W/ POWER STEERING	-	0213-0557
KING QUAD 500 (REAR AXLES) 11-12 4X4-W/ POWER STEERING	0213-0556	0213-0557
Q.U.V. 620 05 4X4	0213-0039	0213-0042
KING QUAD 700 (FRONT AXLES) 05 4X4	0213-0158	0213-0251
KING QUAD 700 (REAR AXLES) 05 4X4	0213-0158	0213-0251
TWIN PEAKS 700 04-05 4X4	0213-0039	0213-0160
KING QUAD 750 (REAR AXLES) 09-12 4X4-W/ POWER STEERING	0213-0556	0213-0557
KING QUAD 750 (FRONT AXLES) 09-12 4X4-W/ POWER STEERING	-	0213-0557
YAMAHA		
TIMBERWOLF 250 94-00 4X4	0213-0039	0213-0042
BIG BEAR 350 87-96 4X4	0213-0039	0213-0042
BIG BEAR 350 97 4X4-W/ 68 AC IB	0213-0039	0213-0042
BIG BEAR 350 97 4X4-W/ 68 LAC IB	0213-0039	0213-0041
BIG BEAR 350 98-99 4X4	0213-0039	0213-0041
BRUIN 350 04-06 4X4	0213-0039	0213-0042
GRIZZLY 350 (FRONT AXLE) 07-08 4X4-EXC. IRS	0213-0039	0213-0042

FITS MODEL	OUTBOARD PART #	INBOARD PART #
CV BOOT KITS (CON'T)		
YAMAHA (CON'T)		
RIZZLY 350 (FRONT AXLE) 07-08 4X4-W/ IRS	0213-0039	0213-0160
GRIZZLY 350 (REAR AXLE) 07-08 4X4-W/ IRS	0213-0039	0213-0041
WOLVERINE 350 95-05 4X4	0213-0039	0213-0041
BIG BEAR 400 (FRONT AXLES) 00-01 4X4-EXC. IRS	0213-0039	0213-0041
BIG BEAR 400 (FRONT AXLES) 02-06 4X4-EXC. IRS	0213-0039	0213-0042
BIG BEAR 400 (FRONT AXLES) 07-08 4X4-W/ IRS	0213-0039	0213-0160
BIG BEAR 400 (REAR AXLE) 07-08 4X4-W/ IRS	0213-0039	0213-0041
GRIZZLY 400 (FRONT AXLE) 07 4X4	0213-0039	0213-0042
GRIZZLY 400 (REAR AXLE) 07 4X4	0213-0039	0213-0041
KODIAK 400 (FRONT AXLE) 93-06 4X4	0213-0039	0213-0042
KODIAK 400 (REAR AXLE) 05-06 4X4	0213-0039	0213-0041
GRIZZLY 450 (FRONT AXLE) 07 4X4	0213-0039	0213-0041
GRIZZLY 450 (FRONT AXLE) 08 4X4	0213-0039	0213-0160
GRIZZLY 450 (REAR AXLE) 07-08 4X4	0213-0039	0213-0041
KODIAK 450 (FRONT AXLE) 03-06 4X4	0213-0039	0213-0041
KODIAK 450 (REAR AXLE) 05-06 4X4	0213-0039	0213-0041
RHINO 450 (FRONT AXLE) 06 4X4	0213-0252	0213-0160
RHINO 450 (REAR AXLE) 06 4X4	0213-0252	0213-0041
WOLVERINE 450 SPORT 06-08 4X4	0213-0039	0213-0042
GRIZZLY 600 98-01 4X4	0213-0039	0213-0041
GRIZZLY 660 (FRONT AXLE) 02 4X4	0213-0039	0213-0041
GRIZZLY 660 (FRONT AXLE) 03 4X4-W/ 68 LAC OB	0213-0039	0213-0250
GRIZZLY 660 (FRONT AXLE) 03 4X4-W/ WJ 68 OB	0213-0310	0213-0250
GRIZZLY 660 (FRONT AXLE) 04-08 4X4	0213-0039	0213-0250
GRIZZLY 660 (REAR AXLE) 02 4X4	0213-0039	0213-0041
GRIZZLY 660 (REAR AXLE) 03 4X4	0213-0310	0213-0041
GRIZZLY 660 (REAR AXLE) 04-08 4X4	0213-0039	0213-0041
RHINO 660 (FRONT AXLE) 04 4X4	0213-0039	0213-0041
RHINO 660 (FRONT AXLE) 05-07 4X4	0213-0252	0213-0160
RHINO 660 (REAR AXLE) 04 4X4	0213-0039	0213-0041
RHINO 660 (REAR AXLE) 05-07 4X4	0213-0252	0213-0041
GRIZZLY 700 (FRONT AXLE) 07-08 4X4	0213-0320	0213-0042
GRIZZLY 700 (REAR AXLE) 07-08 4X4	0213-0320	0213-0042
RHINO 700 SE (FRONT AXLE) 08 4X4	0213-0252	0213-0041
RHINO 700 SE (REAR AXLE) 08 4X4	-	0213-0252
RHINO 700 08-13 4X4-(FRONT AXLES)	0213-0603	0213-0041
RHINO 700 08-13 4X4-(REAR AXLES)	0213-0603	0213-0041



PLOWS
WINCHES
UTV
RACKS
IMPLEMENT & TOWING
LUGGAGE
BODY
CONTROLS
ELECTRICAL
WHEELS & TIRES
SUSPENSION & DRIVE
BRAKING
ENGINE
RIDER
GARAGE
PROMO

SUSPENSION & DRIVE

FRONT WHEEL CYLINDER REPAIR KITS

Rebuild kits for the wheel cylinders of front hydraulic drum brakes. Each kit includes all necessary parts for one side brake system.



FITS MODEL	PART #
FRONT WHEEL CYLINDER REPAIR KITS	
HONDA	
TRX200 84	1702-0003
TRX200 FOURTRAX 90-96	1702-0002
TRX250 FOURTRAX 85-87	1702-0003
TRX250 97-01	1702-0002
TRX250TE/TM 02-09	1702-0002
TRX300 FOURTRAX 88-98	1702-0002
TRX300FW FOURTRAX 88-00	1702-0004
TRX350/D FOURTRAX 86-89	1702-0005
TRX350 00-03	1702-0004
TRX350 04-06	1702-0087
TRX400FW FOREMAN 95-98	1702-0004
TRX400FA/FGA 04-07	1702-0087
TRX400FW 99-03	1702-0087
TRX450ES/S 98-04	1702-0087
TRX500FA/FGA 01-04	1702-0087
TRX650FA 03-05	1702-0087
KAWASAKI	
KLF300 BAYOU 86-87	1702-0006
SUZUKI	
LTF4WD QUADRUNNER 97-98	1702-0007
LTF250 QUADRUNNER 88-01	1702-0007
LT4WD QUADRUNNER 87-96	1702-0007
LTF4WDX KING QUAD 91-98	1702-0007
YAMAHA	
YFM350U BIG BEAR 96-98	1702-0008
YFM350F/FW BIG BEAR 87-98	1702-0008
YFM400F/FW KODIAK 93-98	1702-0008



CENTER DRIVE SHAFT BEARING ASSEMBLIES

More aggressive than the OEM seal. Keeps dirt and water out of the bearing better than OEM. Sold as a complete assembly.

FITS MODEL	PART #
CENTER DRIVE SHAFT BEARING ASSEMBLIES	
ARCTIC CAT	
WILDCAT SPORT 700 15-17	1205-0247
WILDCAT TRAIL 700 17	1205-0247
WILDCAT TRAIL / XT 700 14-17	1205-0247
WILDCAT 1000 14-15	1205-0247
WILDCAT 1000 LATE BUILD 13	1205-0247
WILDCAT 4 1000 13-14	1205-0247
WILDCAT 4 LTD 1000 14	1205-0247
WILDCAT 4X 1000 14-15	1205-0247
WILDCAT GT 1000 13	1205-0247
WILDCAT LTD 1000 13-14	1205-0247
WILDCAT X 1000 13	1205-0247
WILDCAT X / LTD 1000 14-16	1205-0247
CAN-AM	
COMMANDER MAX 800 DPS 16-19	1205-0248
DEFENDER MAX 800 DPS 17-19	1205-0327
DEFENDER MAX 800 XT 17-19	1205-0327
MAVERICK TRAIL 800R 18-19	1205-0327
MAVERICK TRAIL 800R DPS 18-19	1205-0327
MAVERICK X3 900 17	1205-0327
MAVERICK X3 900 HO 18	1205-0327
MAVERICK X3 MAX TURBO 900 18-19	1205-0327
MAVERICK X3 MAX TURBO R 900 18-19	1205-0327
MAVERICK X3 MAX TURBO R XDS 900 18-19	1205-0327
MAVERICK X3 MAX TURBO R XRS 900 18-19	1205-0327
MAVERICK X3 TURBO 900 18-19	1205-0327

FITS MODEL	PART #
CENTER DRIVE SHAFT BEARING ASSEMBLIES (CON'T)	
CAN-AM (CON'T)	
MAVERICK X3 TURBO R 900 18-19	1205-0327
MAVERICK X3 TURBO R XDS 900 18-19	1205-0327
MAVERICK X3 TURBO R XMR 900 18-19	1205-0327
MAVERICK X3 TURBO R XRC 900 18-19	1205-0327
MAVERICK X3 TURBO R XRS 900 18-19	1205-0327
MAVERICK X3 TURBO XMR 900 18-19	1205-0327
MAVERICK X3 TURBO XRC 900 18-19	1205-0327
MAVERICK X3 XDS 900 17	1205-0327
MAVERICK X3 XRS 900 17	1205-0327
COMMANDER MAX 1000 DPS 18-19	1205-0248
COMMANDER MAX 1000 LTD 15-19	1205-0248
COMMANDER MAX 1000 STD 15-19	1205-0248
COMMANDER MAX 1000 XT 18-19	1205-0248
COMMANDER MAX 1000 XT/DPS 15-17	1205-0248
COMMANDER MAX 1000 XT/DPS/LTD 14	1205-0248
COMMANDER MAX 1000 XTP 15	1205-0248
DEFENDER MAX 1000 18-19	1205-0327
DEFENDER MAX 1000 DPS 17-19	1205-0327
DEFENDER MAX 1000 LONE STAR 18-19	1205-0327
DEFENDER MAX 1000 XT 17-19	1205-0327
MAVERICK 1000 TURBO XDS 15-16	1205-0248
MAVERICK 1000 XDS 15-16	1205-0248
MAVERICK MAX 1000 STD 14-18	1205-0248
MAVERICK MAX 1000 TURBO 16-17	1205-0248
MAVERICK MAX 1000 TURBO XDS 15-17	1205-0248
MAVERICK MAX 1000 TURBO XRS 16-17	1205-0248
MAVERICK MAX 1000 XC/XXC 16	1205-0248
MAVERICK MAX 1000 XDS 14-16	1205-0248
MAVERICK MAX 1000 XMR 17-18	1205-0248
MAVERICK MAX 1000 XRS 14-15	1205-0248
MAVERICK SPORT 1000 19	1205-0327
MAVERICK SPORT 1000 DPS 19	1205-0327
MAVERICK SPORT 1000R XMR 19	1205-0327
MAVERICK SPORT 1000R XRC 19	1205-0327
MAVERICK TRAIL 1000 18-19	1205-0327
MAVERICK TRAIL 1000 DPS 18-19	1205-0327
POLARIS	
RANGER 4X4 500 CREW 11-13	1205-0247
RANGER 570 CREW 14-19	1205-0248
RANGER 570 CREW EPS 14-19	1205-0248
RANGER 570 FULL SIZE CREW 15-16	1205-0248
RANGER 570 XP 16	1205-0248
RANGER 570-6 FULL SIZE CREW 16-19	1205-0248
RANGER 4X4 800 EFI CREW 11-14	1205-0247
RZR 4 800 11-14	1205-0232
RANGER 4X4 900 DIESEL 11-14	1205-0232
RANGER 4X4 900 DIESEL CREW 12-14	1205-0232
RANGER 900 CREW 14-19	1205-0248
RANGER 900 CREW EPS 14-19	1205-0248
RANGER 900D HIPPO MPS 14	1205-0232
RANGER DIESEL INTL 14	1205-0232
RZR 4 900 15-18	1205-0248
RZR 4 XP 900 12-14	1205-0248
RZR 4 XP JAGGED X 13	1205-0248
RZR 900 50 55 INCH 15-17	1205-0248
RZR 900 50 INCH 18-19	1205-0248
RZR 900 50 INCH EPS 18-19	1205-0248
RZR 900 50 INCH MD 17	1205-0248
RZR 900 60 INCH 16-19	1205-0248
RZR 900 60 INCH BUILT AFTER 3/2/15 15	1205-0248
RZR 900 60 INCH BUILT BEFORE 3/1/15 15	1205-0248
RZR XP 900 11	1205-0232
RZR XP 900 12-14	1205-0248
GENERAL 1000 EPS 16-19	1205-0248
GENERAL 4 1000 EPS 17-19	1205-0248
RANGER 1000 DIESEL CREW 15-18	1205-0248
RANGER 1000 EPS BASE 18	1205-0248
RANGER 1000 EPS HD MD 19	1205-0248
RANGER XP 1000 EPS CREW 19	1205-0248
RANGER XP 1000 EPS CREW MUD 19	1205-0248
RANGER XP 1000 EPS CREW NSTR 19	1205-0248
RZR 1000 60 INCH 16-19	1205-0248
RZR RS1 18-19	1205-0248
RZR S4 1000 19	1205-0248
RZR XP 1000 14-19	1205-0248
RZR XP 1000 BUILT AFTER 10/20/15 16	1205-0248

FITS MODEL	PART #
CENTER DRIVE SHAFT BEARING ASSEMBLIES (CON'T)	
POLARIS (CON'T)	
RZR XP 1000 BUILT BEFORE 10/19/15 16	1205-0248
RZR XP 1000 INTL 15	1205-0248
RZR XP 4 1000 14-19	1205-0248
RZR XP 4 1000 BUILT AFTER 10/20/15 16	1205-0248
RZR XP 4 1000 BUILT BEFORE 10/19/15 16	1205-0248
RZR XP 4 TURBO 16-19	1205-0248
RZR XP 4 TURBO BUILT AFTER 6/5/17 18	1205-0248
RZR XP 4 TURBO BUILT BEFORE 6/6/17 18	1205-0248
RZR XP TURBO 16-19	1205-0248
RZR XP TURBO BUILT AFTER 6/5/17 18	1205-0248
RZR XP TURBO BUILT BEFORE 6/6/17 18	1205-0248
RZR XP TURBO MD 16	1205-0248
RZR XP TURBO TRACTOR 17	1205-0248
RZR XP TURBO TRACTOR BUILT AFTER 6/5/17 18	1205-0248
RZR XP TURBO TRACTOR BUILT BEFORE 6/6/17 18	1205-0248
TEXTRON	
WILDCAT SPORT 18	1205-0247
WILDCAT TRAIL / XT 18	1205-0247
WILDCAT 4X LTD 18	1205-0247
WILDCAT X EPS 18	1205-0247
WILDCAT X LTD EPS 18	1205-0247
WILDCAT XX EPS 18	1205-0247



LIMIT STRAPS

Protect your axles and shocks from common overextension issues. Works on all Polaris RZR XP 1000. Reduces stress on axles, prevents axle binding and steering binding. Works well with stock and aftermarket shocks.

FITS MODEL	58.5 CM (23") FRONT PART #	84 CM (33") REAR PART #
POLARIS		
RZR 1000 XP (ALL)	0450-0514	0450-0515



BILLET PROP SHAFT BEARING CARRIER

Housing is made from 6061 billet aluminum. Incorporates a greasable high speed bearing. Reduces driveline misalignment. Offers additional support and strength for the prop shafts. Will outlast and outperform the cheap OEM bearing carrier. Mounting hardware and instructions included.

FITS MODEL	PART #
POLARIS	
GENERAL 1000 (ALL MODELS) 16-19	1205-0328
RZR 900 (ALL MODELS) 15-19	1205-0328
RZR 1000 XP (ALL MODELS) 14-19	1205-0328
RZR TURBO 16-17	1205-0328



STARTER DRIVES

Replaces OEM starter drive.

FITS MODEL	PART #
STARTER DRIVES	
CAN-AM	
OUTLANDER 330 XT 4X4 05	2110-0443
OUTLANDER 330 STD 2X4 04-05	2110-0443
OUTLANDER 330 STD 4X4 04-05	2110-0443
OUTLANDER 400 2X4 03-05	2110-0443
OUTLANDER 400 4X4 04	2110-0443
OUTLANDER 400 XT 4X4 04-08	2110-0443
OUTLANDER 400 STD 4X4 05-08	2110-0443
OUTLANDER 400 MAX 04-05	2110-0443
OUTLANDER 400 MAX STD 4X4 06-08	2110-0443
OUTLANDER 400 MAX XT 4X4 06-08	2110-0443
OUTLANDER 400 EFI STD 08-12	2110-0443
OUTLANDER 400 EFI XT 08-12	2110-0443
OUTLANDER 400 EFI MAX STD 08-12	2110-0443
OUTLANDER 400 EFI MAX XT 08-12	2110-0443
POLARIS	
250 2X4 93	2110-0407
250 4X4 93	2110-0407
250 6X6 93	2110-0407
BIG BOSS 250 89	2110-0407
BIG BOSS 250 4X6 89-92	2110-0407
BIG BOSS 250 6X6 91-92	2110-0407
CYCLONE 250 87	2110-0407
SCRAMBLER 250 85-86	2110-0407
TRAIL BLAZER 250 90-06	2110-0407
TRAIL BOSS 250 85-99	2110-0407
TRAIL BOSS 250 2X4 88-92	2110-0407
TRAIL BOSS 250 4X4 87-93	2110-0407
TRAIL BOSS 250R/ES 88	2110-0407
XPLORER 250 01	2110-0407
300 2X4 & 4X4 94-95	2110-0407
TRAIL BOSS 300 2X4 & 4X4 95	2110-0407
XPLORER 300 97-00	2110-0407
XPLORER 300 4X4 95-00	2110-0407
XPRESS 300 96-99	2110-0407
MAGNUM 325 2X4 00-02	2110-0407
MAGNUM 325 4X4 00-02	2110-0407
TRAIL BOSS 325 00-01	2110-0407
XPEDITION 325 00-02	2110-0407
ATP330 4X4 04-05	2110-0407
MAGNUM 330 2X4 03-05	2110-0407
MAGNUM 330 4X4 03-06	2110-0407
MAGNUM 330 HDS 03	2110-0407
TRAIL BLAZER 330 09-10	2110-0407
TRAIL BOSS 330 04-06	2110-0407
SPORTSMAN 335 99-00	2110-0407
WORKER 335 99	2110-0407

FITS MODEL	PART #
STARTER DRIVES (CON'T)	
POLARIS (CON'T)	
350L 2X4 & 4X4 93	2110-0407
TRAIL BOSS 350L 2X4 91-92	2110-0407
TRAIL BOSS 350L 4X4 91-92	2110-0407
SCRAMBLER 380 2X4 00	2110-0407
BIG BOSS 400L 6X6 95-97	2110-0407
RANGER 400 4X4 10	2110-0407
SCRAMBLER 400 95-00	2110-0407
SCRAMBLER 400 2X4 & 4X4 01-02	2110-0407
SCRAMBLER 400L 97	2110-0407
SPORT 400 98-05	2110-0407
SPORT 400L 94-97	2110-0407
SPORTSMAN 400 94-05	2110-0407
XPLORER 400 98-02	2110-0407
XPLORER 400 4X4 95	2110-0407
XPLORER 400L 96-97	2110-0407
XPRESS 400L 96-97	2110-0407
MAGNUM 425 2X4 95-98	2110-0407
MAGNUM 425 4X4 96-97	2110-0407
RANGER 425 2X4 04	2110-0407
XPEDITION 425 00-02	2110-0407
SPORTSMAN 450 06-07	2110-0407
ATP 500 4X4 04	2110-0407
BIG BOSS 500 6X6 98-99	2110-0407
MAGNUM 500 99-01	2110-0407
MAGNUM 500 4X4 97-03	2110-0407
SCRAMBLER 500 2X4 97-08	2110-0407
SCRAMBLER 500 4X4 97-08	2110-0407
SPORTSMAN 500 4X4 96-03	2110-0407
SPORTSMAN 500 6X6 99-04	2110-0407
SPORTSMAN 500 EFI TRACTOR 10	2110-0407
SPORTSMAN 500 HO EFI 4X4 06-09	2110-0407
SPORTSMAN 500 NON-EFI 4X4 04	2110-0407
SPORTSMAN 500 NON-EFI HO 05-06	2110-0407
SPORTSMAN 500X2 2-UP 06-08	2110-0407
SPORTSMAN 600 4X4 03-05	2110-0486
SPORTSMAN 700 4X4 02-08	2110-0486
SPORTSMAN 800 EFI 4X4 05-13	2110-0486
SPORTSMAN 800 EFI 6X6 09-13	2110-0486
SPORTSMAN 800 EFI X2 07	2110-0486
SPORTSMAN TOURING 800 EFI 4X4 08-09	2110-0486
WORKER 500 98-02	2110-0407
XPLORER 500 97-01	2110-0407
RANGER 500 99	2110-0407
RANGER 500 2X4 03	2110-0407
RANGER 500 2X4 07-08	2110-0407
RANGER 500 4X4 03-04	2110-0407
RANGER 500 4X4 06-07	2110-0407
RANGER 500 4X4 EFI 06-09	2110-0407
RANGER 500 6X6 03-05	2110-0407
RANGER 700 XP 4X4 06-09	2110-0486
RANGER 700 EFI 6X6 06-09	2110-0486
RANGER 800 EFI 4X4 10-12	2110-0486
RANGER 800 EFI 6X6 10-13	2110-0486
RZR 800 EFI 08-10	2110-0486
RZR 800 EFI 12	2110-0486
RZR 800 EFI S 09-10	2110-0486
RZR 800 EFI S 12	2110-0486



ONE WAY CLUTCH BEARING

Top-quality Japanese one way clutch bearing. Just one bearing fits many models just by flipping it over for installation.

FITS MODEL	PART #
HONDA	
ATC250ES/SX 85-87	0924-0424
TRX300/FW 88-00	0924-0424
TRX350FE/FM/TE/TM 00-06	0924-0424
TRX400FW 95-03	0924-0424
TRX420FE/FM/TE/TM 07-17	0924-0424
TRX420FPE/FPM 09-13	0924-0424
TRX450ES/S 98-01	0924-0424
TRX450FE/FM 02-04	0924-0424
TRX500FE/FM/TM 05-14	0924-0424
TRX500FPE/FPM 09-13	0924-0424
SUZUKI	
LT-A400 03-09	0924-0425
LT-A400F 03-15	0924-0425
LT-F400 02-08	0924-0425
LT-F400F 02-15	0924-0425
LT-A450X 07-10	0924-0425
LT-A500F 00-07	0924-0425
LT-A500X 09-15	0924-0425
LT-F500F 98-07	0924-0425
LT-A700X 05-07	0924-0425
LT-A750X 08-15	0924-0425
YAMAHA	
YFM350FW BIG BEAR 97-99	0924-0425
YFM350FX WOLVERINE 97-05	0924-0425
YFM350U BIG BEAR 99	0924-0425
YFM350 BRUIN 04-06	0924-0426
YFM350 BRUIN 04-06	0924-0426
YFM350FG GRIZZLY 07-13	0924-0426
YFM350G GRIZZLY 07-11	0924-0426
YFM350X WOLVERINE 06-09	0924-0426
YFM400 BIG BEAR 00-04	0924-0425
YFM400F BIG BEAR 00-12	0924-0425
YFM400FW KODIAK 96-99	0924-0425
YFM400 KODIAK 00-04	0924-0426
YFM400F KODIAK 00-06	0924-0426
YFM400FG GRIZZLY 07-08	0924-0426
YFM450 KODIAK 03-06	0924-0426
YFM450FX WOLVERINE 06-10	0924-0426
YFM450FG GRIZZLY 07-14	0924-0426
YXR450F RHINO 06-09	0924-0426
YFM550F GRIZZLY 09-12	0924-0425
YFM600 GRIZZLY 98-01	2110-0956
YFM600F GRIZZLY 98-01	0924-0425
YFM660F GRIZZLY 02-08	0924-0425
YXR660F RHINO 04-07	0924-0425
YFM700 GRIZZLY 07-15	0924-0425
YXE700 WOLVERINE 16	0924-0425
YXM700 VIKING 14-16	0924-0425



SHOCK COVERS

Protects your shocks from mud, dust and debris. Made of durable 400 denier nylon cloth. Strong, durable 51 mm (2") hook and loop closure strip. High-strength elastic at both ends and four vented holes for better ventilation. Made in the USA.

BLACK	RED	BLUE	WIDTH	LENGTH
MUD-P09	MUD-P18	MUD-P27	25,5 CM (10")	33 CM (13")
MUD-P19	-	-	25 CM (9 3/4")	26,5 CM (10 1/2")
MUD-P29	-	-	26,5 CM (10 1/2")	31 CM (12 1/4")
MUD-S09	MUD-S18	MUD-S27	28 CM (11")	30,5 CM (12")
MUD-S29	MUD-S38	MUD-S47	32 CM (12 1/2")	37,5 CM (14 3/4")
MUD-S19	-	-	29 CM (11 1/2")	34,5 CM (13 1/2")



FAST-BOOT X

Made from premium quality rubber in the USA to minimize abrasion wear and provide a long service life. Can be installed like a traditional boot or "over-the-joint" using a Quick-Shot or installation cone. Provides extended coverage for ATV/UTV heavy duty and extended suspension axle applications. Features a patented continuous convoluted design to more evenly distribute wear and minimize flex fatigue. Each kit includes a Fast-Boot X, stainless steel clamps, CV grease, and detailed instructions. Made in the USA.

DESCRIPTION	PART #
EACH	0213-0656
6-PACK	0213-0657
COMBO 6-PACK (4 LARGE, 2 REGULAR)	0213-0658



FAST BOOT II

ATV CV boot that fits virtually all ATVs. Made from the finest neoprene rubber available. One fast boot provides the coverage for front or rear axles and inner or outer joints. Made in the USA.

DESCRIPTION	PART #
FAST BOOT KIT	0213-0427
6-PACK BOOTS	0213-0428
24-PACK W/ GREASE AND CLAMPS	0213-0830



BOOT CLAMPS

Boot kits use the free-end style clamps that offer the advantage of allowing the installer to apply the desired amount of torque. Made in the USA.

DESCRIPTION	PART #
5MM X 254MM (EACH)	M92-06802
5MM X 254MM (25 PIECES)	M92-06803
6MM X 482MM (EACH)	M92-06804
6MM X 482MM (25 PIECES)	M92-06805
REPLACEMENT CLAMPS (SET OF 4)	M92-06806



QUICK-SHOT CV BOOT INSTALLATION KIT

The Fast Boot/Quick Shot combination provides the fastest, cleanest and most effortless method possible to replace CV boot on any major brand ATV or UTV. The tool utilizes air pressure to expand the CV boot for "over the joint" installations. Use only Fast Boots with your Quick Shot. OEM and other aftermarket boots may cause the steel legs of the tool to bend or CV boot may be torn. Made in the USA.

FAST BOOT PREMIUM TOOL

High strength construction and a convenient ratchet provides the tension needed for properly securing the fast boot clamps. Made in the USA.

FAST BOOT STANDARD TOOL

Standard banding tool: Features a tensioning nut and lever action to provide a simple, yet effective method for installing fast boot clamps. Works with 12,7 mm (1/2") socket. Made in the USA.

DESCRIPTION	PART #
QUICK SHOT CV BOOT INSTALLATION KIT	3811-0038
FAST BOOT TOOL (PREMIUM)	M92-06811
FAST BOOT TOOL (STANDARD)	M92-06812



SPANNER TOOL

Eases the job of suspension adjustment. Made in the USA.

DESCRIPTION	PART #
SPANNER TOOL	3805-0180



CV BOOT CLAMPS

Ear clamp style. Easier and faster to install - no threading clamp tail into banding tool nose and mandrel. Does not require banding tool to tighten - clamps can be tightened with a pincher style pliers, large side cutters or an ear-clamp pliers.

DESCRIPTION	PART #
6MM X 40MM (EA.)	0213-0728
6MM X 40MM (25 COUNT)	0213-0729
8MM X 90MM (EA.)	0213-0730
8MM X 90MM (25 COUNT)	0213-0731
BOOT CLAMP KIT UNIVERSAL	0213-0732

LIFT KITS

Increases clearance by 25.4 mm - 38.1 mm (1"-1 1/2").
Made of stainless steel.
Easy installation, no special tools required.



FITS MODEL	PART #
LIFT KITS	
CAN-AM	
OUTLANDER 500 13-14	1304-0914
OUTLANDER 500 DPS 13-15	1304-0914
OUTLANDER 500 XT 13-15	1304-0914
RENEGADE 500 13-15	1304-0914
OUTLANDER 570 DPS 16	1304-0914
OUTLANDER 570 XT 16	1304-0914
OUTLANDER 650 13-16	1304-0914
OUTLANDER 650 DPS 13-16	1304-0914
OUTLANDER 650 XT 13-16	1304-0914
OUTLANDER 800 XT 13	1304-0914
OUTLANDER 800R 13-15	1304-0914
OUTLANDER 800R DPS 13-15	1304-0914
OUTLANDER 800R XT 14-15	1304-0914
RENEGADE 800R 13-15	1304-0914
RENEGADE 800R XXC 14	1304-0914
RENEGADE 800R XXC-DPS 15	1304-0914
OUTLANDER 850 DPS 16	1304-0914
OUTLANDER 850 XT 16	1304-0914
RENEGADE 850 16	1304-0914
RENEGADE 850 XXC 16	1304-0914
OUTLANDER 1000 12-13	1304-0914
OUTLANDER 1000 DPS 13-16	1304-0914
OUTLANDER 1000 LTD 13	1304-0914
OUTLANDER 1000 XT 13-16	1304-0914
RENEGADE 1000 12-16	1304-0914
RENEGADE 1000 XXC 14-16	1304-0914
DEFENDER HD10 16-19	1304-0915
DEFENDER HD10 XT 17	1304-0915
DEFENDER HD10 CAB 16-17	1304-0915
DEFENDER HD10 DPS 16-17	1304-0915
DEFENDER HD10 DPS 18-19	1304-0915
DEFENDER HD10 XT 16-19	1304-0915
DEFENDER HD8 16-19	1304-0915
DEFENDER HD8 BASE 17	1304-0915
DEFENDER HD8 DPS 16-19	1304-0915
DEFENDER HD8 XT 16-19	1304-0915
HONDA	
RANCHER 420 2X4 14-19	1304-0917
RANCHER 420 4X4 14-19	1304-0917
RANCHER 420 4X4 PS 14	1304-0917
RANCHER 420 AUTO DCT 4X4 14-16	1304-0917
RANCHER 420 AUTO DCT EPS 4X4 15-19	1304-0917
RANCHER 420 AUTO DCT PS 4X4 14	1304-0917
RANCHER 420 EPS 4X4 15-16	1304-0917
RANCHER 420 ES 2X4 14-16	1304-0917
RANCHER 420 ES 4X4 14-19	1304-0917
RANCHER 420 IRS AUTO DCT 15-19	1304-0918
RANCHER 420 IRS AUTO DCT EPS 15-19	1304-0918
FOREMAN 500 4X4 14-19	1304-0917
FOREMAN 500 4X4 PS 14	1304-0917
FOREMAN 500 EPS 4X4 15-16	1304-0917
FOREMAN 500 ES 4X4 14-16	1304-0917
FOREMAN 500 ES 4X4 PS 14	1304-0917
FOREMAN 500 ES EPS 4X4 15-19	1304-0917
RUBICON 500 4X4 15-16	1304-0918
RUBICON 500 DCT 15-19	1304-0918
RUBICON 500 DCT EPS 15-19	1304-0918
RUBICON 500 DCT EPS DELUXE 15-19	1304-0918
RUBICON 500 EPS 15-19	1304-0918
RUBICON 500 EPS DELUXE 15-19	1304-0918
PIONEER 1000 16-19	1304-0916
PIONEER 1000 EPS 17-19	1304-0916
PIONEER 1000 LE 17-19	1304-0916
PIONEER 1000-5 16-19	1304-0916
PIONEER 1000-5 DELUXE 17-19	1304-0916
PIONEER 1000-5 LE9 17-19	1304-0916
KAWASAKI	
TERYX 750 4 EPS 12	1304-0920
TERYX 800 14-19	1304-0920
TERYX 800 4 14-19	1304-0920

FITS MODEL	PART #
LIFT KITS (CON'T)	
KAWASAKI (CON'T)	
TERYX 750 4 12-13	1304-0920
TERYX 800 4 LE 15-19	1304-0920
TERYX 800 LE 14-19	1304-0920
TERYX 800 LE 4 14-19	1304-0920
MULE PRO-DX 16-18	1304-0921
MULE PRO-DX EPS 17-18	1304-0921
MULE PRO-DX EPS LE 16-18	1304-0921
MULE PRO-DXT 16-18	1304-0921
MULE PRO-DXT EPS 16-18	1304-0921
MULE PRO-DXT EPS LE 16-18	1304-0921
MULE PRO-FX 16-19	1304-0921
MULE PRO-FX EPS 16-19	1304-0921
MULE PRO-FX EPS LE 16-19	1304-0921
MULE PRO-FX RANCH 18-19	1304-0921
MULE PRO-FXR 18-19	1304-0921
MULE PRO-FXT 15-19	1304-0921
MULE PRO-FXT EPS 15-19	1304-0921
MULE PRO-FXT EPS LE 15-19	1304-0921
MULE PRO-FXT RANCH 17-19	1304-0921
POLARIS	
RANGER EV 18	1304-0923
RANGER ETX 15-16	1304-0923
SPORTSMAN ETX 15	1304-0925
SPORTSMAN 400 HO 4X4 12-14	1304-0925
SPORTSMAN 450 06-07	1304-0925
SPORTSMAN 450 HO 16-19	1304-0925
RANGER 500 MIDSIZE 17-19	1304-0923
SPORTSMAN 500 EFI 07,09	1304-0925
SPORTSMAN 500 HO 06-13	1304-0925
SPORTSMAN 500 HO EFI 06,08	1304-0925
SPORTSMAN 500 TOURING 12	1304-0925
SPORTSMAN 550 11-13	1304-0922
SPORTSMAN 550 EPS 10-14	1304-0922
SPORTSMAN 550 TOURING 14	1304-0922
SPORTSMAN 550 TOURING EPS 13	1304-0922
SPORTSMAN 550 X2 EFI 10-12	1304-0922
SPORTSMAN 550 XP 09-11	1304-0922
RANGER 570 CREW FULL SIZE 18-19	1304-0923
RANGER 570 CREW MIDSIZE 15-19	1304-0923
RANGER 570 CREW MIDSIZE EPS 15-19	1304-0923
RANGER 570 FULL SIZE 18-19	1304-0923
RANGER 570 FULL SIZE STRUT 16-19	1304-0923
RANGER 570 MIDSIZE 14-18	1304-0923
RANGER 570 MIDSIZE EPS 16-19	1304-0923
RANGER 570-4 CREW MIDSIZE 18-19	1304-0923
RANGER 570-4 FULL SIZE CREW 16-19	1304-0923
RANGER 570-4 FULL SIZE CREW EPS 17-19	1304-0923
RANGER 570-6 CREW MIDSIZE 18-19	1304-0923
RANGER 570-6 FULL SIZE CREW 16-19	1304-0923
RZR 570 12-19	1304-0924
RZR 570 EPS 15-19	1304-0924
SPORTSMAN 570 14-19	1304-0925
SPORTSMAN 570 TOURING 16-19	1304-0925
RANGER 570 CREW FULL SIZE 15	1304-0926
RANGER 570 FULL SIZE 15	1304-0926
RANGER 570 FULL SIZE XP 16	1304-0926
SPORTSMAN 600 05	1304-0925
SPORTSMAN 700 05-07	1304-0925
SPORTSMAN 800 EFI 05-14	1304-0925
SCRAMBLER 850 13-18	1304-0922
SPORTSMAN 850 09-17	1304-0922
SPORTSMAN 850 EPS 10-13	1304-0922
SPORTSMAN 850 SP 15-17	1304-0922
SPORTSMAN 850 SP EPS 17	1304-0922
SPORTSMAN 850 TOURING EPS 13-14	1304-0922
SPORTSMAN 850 TOURING SP 15-18	1304-0922
SPORTSMAN 850 X2 EFI 11	1304-0922
RANGER 900 17	1304-0926
RANGER 900 CREW 14-18	1304-0926
RANGER 900-5 CREW EPS 16-19	1304-0926
RANGER 900-6 CREW EPS 16-19	1304-0926
SCRAMBLER 1000 XP 14-18	1304-0922
SPORTSMAN 1000 XP 15-16	1304-0922
RANGER 900 EPS 14-19	1304-0926
SPORTSMAN 1000 XP TOURING 15-18	1304-0922
RANGER 1000 17	1304-0926

FITS MODEL	PART #
LIFT KITS (CON'T)	
POLARIS (CON'T)	
RANGER 1000 CREW 17-18	1304-0926
RANGER 1000 CREW EPS 17	1304-0926
RANGER 1000 CREW HIGH LIFTER EDITION 17	1304-0926
RANGER 1000 DSL 15-16	1304-0926
RANGER 1000 EPS 17	1304-0926
RANGER 1000 HIGH LIFTER EDITION 17-18	1304-0926
RANGER 1000 SE 17	1304-0926
YAMAHA	
VIKING 700 14-19	1304-0927
VIKING 700 VI 15-19	1304-0927

STARTER ONE WAY CLUTCH BEARINGS

OEM replacement. Hard tempered layer to withstand pressure. Precision rails make the rotation flawless.



FITS MODEL	PART #
KAWASAKI	
KVF360 PRAIRIE 03-09	0924-0580
KVF360 4X4 PRAIRIE 03-12	0924-0580
KLF400 4X4 BAYOU 93-99	0924-0580
KVF400 PRAIRIE 99-02	0924-0580
KVF400 4X4 PRAIRIE 97-02	0924-0580
KVF650 4X4 PRAIRIE 02-03	0924-0580
KVF650 4X4 BRUTE FORCE 05-13	0924-0580
KSV700 KFX700 04-09	0924-0580
KVF700 4X4 PRAIRIE 04-06	0924-0580
KRF750 4X4 TERYX 08-13	0924-0580
KVF750 4X4 BRUTE FORCE 05-18	0924-0580
KRF800 TERYX 14-18	0924-0580
SUZUKI	
LT-4WD QUADRUNNER 87-96	0924-0581
LT-F250 QUADRUNNER 88-01	0924-0581
LT-F250F QUADRUNNER 99-02	0924-0581
LT-F4WD QUADRUNNER 97-98	0924-0581
LT-F300F KING QUAD 99-02	0924-0581
LT-F4WDX KING QUAD 91-98	0924-0581
YAMAHA	
YFM200/DX 85-89	0924-0582
YTM200E/ER 83-85	0924-0582
YFM225 86-88	0924-0582
YTM225DR MOTO-4 85-86	0924-0582
YTM225DX MOTO-4 83-85	0924-0582
YFB250/U TIMBERWOLF 92-98	0924-0582
YFB250FW TIMBERWOLF 94-00	0924-0582
YFM250 MOTO-4 89-91	0924-0582
YFM250X BEAR TRACKER 99-04	0924-0582
YFM350ER MOTO-4 87-95	0924-0583
YFM350FW BIG BEAR 87-99	0924-0583
YFM350FX WOLVERINE 00-05	0924-0583
YFM350R/S RAPTOR 04-13	0924-0583
YFM350U BIG BEAR 96-99	0924-0583
YFM350/FA BRUIN 04-06	0924-0584
YFM350FG GRIZZLY 07-14	0924-0584
YFM350X WOLVERINE 06-09	0924-0584
YFM350X WARRIOR 87-04	0924-0583
YFM400 BIG BEAR 00-04	0924-0583
YFM400A/FA KODIAK 01-06	0924-0583
YFM400F/FW BIG BEAR 01-12	0924-0583
YFM400FG GRIZZLY 07-08	0924-0583
YFM400FW KODIAK 93-99	0924-0583
YFM450FA KODIAK 03-06	0924-0583
YFM450FG GRIZZLY 07-14	0924-0583
YFM450K KODIAK 18	0924-0583
YFM450FX WOLVERINE 06-10	0924-0583
YXR450FA RHINO 06-09	0924-0583
YFM550FG GRIZZLY 09-14	0924-0584
YFM660F GRIZZLY 03-08	0924-0584
YXR660F RHINO 04-07	0924-0584
YFM700FG GRIZZLY 07-13	0924-0584
YXC/YXM700V VIKING 16-18	0924-0584
YXR700F RHINO 08-13	0924-0584

SUSPENSION & DRIVE



HIGH PERFORMANCE PLUS DRIVE BELTS

Provides fast, more consistent throttle response at high speeds and quicker throttle response at mid-speed acceleration. Greater secondary acceleration at high RPM's. Reduction in slippage during the highest levels of torque. Increased horsepower capacity. Better performance during deceleration. Tested and proven reliable at well over 12,000 RPM's. Cooler running than the leading competitors. Made in the USA.

FITS MODEL	PART #
HIGH PERFORMANCE PLUS DRIVE BELTS	
ARCTIC CAT	
350 11	1142-0294
366 09	1142-0294
366 4X4 AUTO 08	1142-0294
366 SE 10-11	1142-0294
ALTERRA 400 17	1142-0294
400 14	1142-0294
400 CORE 13	1142-0294
TRV 400 09-10, 14	1142-0294
TRV 400 CORE 13	1142-0294
425 11	1142-0294
TRV 450 11	1142-0294
TRV 450I 12	1142-0294
TRV 450I GT 12	1142-0294
450 14	1142-0294
450 CORE 13	1142-0294
450 HI EFI 10-11	1142-0294
450 LTD 11	1142-0294
450I 12	1142-0294
XC 450 13-14	1142-0294
XC 450I 11	1142-0294
ALTERRA 500 17	1142-0294
500 14	1142-0294
500 CORE 13	1142-0294
500 XT 13-14	1142-0294
TRV 500 14	1142-0294
TRV 500 CORE 13	1142-0294
550 11-12, 14	1142-0485
550 CORE 13	1142-0485
550 GT 12	1142-0485
550 HI EFI 09-10	1142-0485
550 HI EFI LE 09-10	1142-0485
550 LTD 11, 13-14	1142-0485
550 S 10-11	1142-0485
550 S LTD 10	1142-0485
550 XT 13-14	1142-0485
TRV 550 11	1142-0485
TRV 550 CRUISER 11	1142-0485
TRV 550 GT 11	1142-0485
TRV 550 HI EFI 09-10	1142-0485
TRV 550 HI EFI LE 09	1142-0485
TRV 550 LIMITED 13-14	1142-0485
TRV 550 S GT 10	1142-0485
TRV 550 XT 13-14	1142-0485
TRV 550 XT EPS 15	1142-0485
TRV 550I CRUISER 12	1142-0485
TRV 550I GT 12	1142-0485
650 4X4 AUTO 04	1142-0249
650 4X4 AUTO LE 04, 06	1142-0249
650 V2 4X4 AUTO/LE 05-06	1142-0249
650 HI 10-11	1142-0485
650 HI 4X4 AUTO 05-08	1142-0485
650 HI 4X4 AUTO LE 07	1142-0485
650 HI 4X4 AUTO TRV 07-08	1142-0485
650 HI 4X4 TBX 07	1142-0485
650 HI 4X4 TRV LE PLUS 07	1142-0485
MUD PRO 650 HI 10-11	1142-0485
TBX 650 09	1142-0485

FITS MODEL	PART #
HIGH PERFORMANCE PLUS DRIVE BELTS (CON'T)	
ARCTIC CAT (CON'T)	
TRV 650 HI 09	1142-0485
ALTERRA 700 17	1142-0485
ALTERRA 700 XT 17	1142-0485
700 EFI 4X4 AUTO 06-08	1142-0271
700 EFI CRUISER 08	1142-0271
700 12, 14	1142-0485
700 CORE 13	1142-0485
700 GT 12	1142-0485
700 HI EFI 09-11	1142-0485
700 HI EFI 4X4 AUTO SE 08	1142-0485
700 HI EFI LE 09-10	1142-0485
700 HI EFI MUD PRO 09	1142-0485
700 HI EFI SE 09	1142-0485
700 LTD 11-14	1142-0485
700 MUD PRO LTD 12	1142-0485
700 S 10-11	1142-0485
700 XT 13-14	1142-0485
MUD PRO 700 HI EFI 10-12	1142-0485
MUDPRO 700 LIMITED 13-14	1142-0485
MUDPRO 700I 12	1142-0485
TBX 700 14	1142-0485
TBX 700 EPS 15	1142-0485
TBX 700 HI EFI 10	1142-0485
TBX 700 LTD 11	1142-0485
TBX 700 XT 13	1142-0485
TBX 700I GT 12	1142-0485
TRV 700 11	1142-0485
TRV 700 HI EFI 10	1142-0485
TRV 700 HI EFI CRUISER 09-10	1142-0485
TRV 700 LIMITED 13-14	1142-0485
TRV 700 LIMITED EPS 15	1142-0485
TRV 700 S GT 10	1142-0485
TRV 700 XT 14-15	1142-0485
TRV 700I GT 12	1142-0485
TVR 700I CRUISER 12	1142-0485
700 DIESEL 07-08	1142-0725
700 SUPER DUTY DIESEL 11-12	1142-0725
SUPER DUTY DIESEL 10	1142-0725
SUPER DUTY DIESEL 13-15	1142-0725
ALTERRA TRV 1000 XT 17	1142-0294
1000 LTD 11	1142-0271
1000 XT 13-14	1142-0271
1000I GT 12	1142-0271
MUD PRO 1000 H2 EFI 10-11	1142-0271
MUDPRO 1000 LIMITED 13-14	1142-0271
THUNDERCAT 1000 H2 08-10	1142-0271
THUNDERCAT 1000 H2 LE 10	1142-0271
TRV 1000 CRUISER 11	1142-0271
TRV 1000 H2 EFI 10	1142-0271
TRV 1000 H2 EFI CRUISER 09-10	1142-0271
TRV 1000 LIMITED 13-14	1142-0271
TRV 1000I CRUISER 12	1142-0271
TRV 1000I GT 12	1142-0271
650 HI 4X4 PROWLER 07	1142-0485
650 HI 4X4 PROWLER XT 07	1142-0485
PROWLER HDX 500 14	1142-0294
PROWLER HDX 500 LIMITED 14	1142-0294
PROWLER HDX 500 XT 14	1142-0294
PROWLER 1000 XT EPS 15	1142-0485
PROWLER 550 HI EFI 09	1142-0485
PROWLER 650 4X4 AUTO 08	1142-0485
PROWLER 650 4X4 AUTO M4 08	1142-0485
PROWLER 700 HDX 13	1142-0485
PROWLER 700 HDX XT EPS 15	1142-0485
PROWLER 700 XT EPS 15	1142-0485
PROWLER 700 XTX 13-14	1142-0485
PROWLER HDX 700 11-12	1142-0485
PROWLER HDX 700 LIMITED 14	1142-0485
PROWLER XT 550 10-14	1142-0485
PROWLER XT 650 HI 09	1142-0485
PROWLER XT 700 HI EFI 09	1142-0485
PROWLER XTX 700 10-12	1142-0485
PROWLER XTX 700 HI EFI LE 08-09	1142-0485
PROWLER XTX 700 HI LE 08-09	1142-0485
PROWLER XTX 1000 10-14	1142-0271
PROWLER XTX 1000 H2 EFI 09	1142-0271

FITS MODEL	PART #
HIGH PERFORMANCE PLUS DRIVE BELTS (CON'T)	
ARCTIC CAT (CON'T)	
WILDCAT TRAIL, TRAIL XT 14	1142-0509
WILDCAT 12	1142-0271
WILDCAT 1000 13	1142-0271
WILDCAT 1000 LTD 13	1142-0271
WILDCAT 4 1000 13	1142-0271
WILDCAT 1000 LTD 14	1142-0487
WILDCAT 1000 14	1142-0487
WILDCAT 4 13-14	1142-0487
WILDCAT 4 AND 4X LIMITED 14	1142-0487
WILDCAT 4X 14	1142-0487
WILDCAT X 13-14	1142-0487
WILDCAT X LIMITED 14	1142-0487
WILDCAT TRAIL 14	1142-0509
WILDCAT TRAIL XT 14	1142-0509
WILDCAT 4X EPS 15-16	1142-0552
WILDCAT 4X LIMITED EPS 15	1142-0552
WILDCAT EPS 15	1142-0552
WILDCAT X EPS 15-16	1142-0552
WILDCAT X LIMITED EPS 15-16	1142-0552
WILDCAT X SPECIAL EDITION 16	1142-0552
CAN-AM	
OUTLANDER 450 L 15	1142-0248
OUTLANDER 500 07-08	1142-0248
OUTLANDER 500 EFI 09-14	1142-0248
OUTLANDER 500 EFI DPS 13-15	1142-0248
OUTLANDER 500 EFI XT 09, 13-15	1142-0248
OUTLANDER 500 XT 07-08	1142-0248
OUTLANDER MAX 500 EFI 09-14	1142-0248
OUTLANDER MAX 500 EFI DPS 13-14	1142-0248
OUTLANDER MAX 500 EFI LTD 09	1142-0248
OUTLANDER MAX 500 EFI XT 09, 13-15	1142-0248
RENEGADE 500 EFI 08-15	1142-0248
OUTLANDER L X MR 570 16	1142-0248
OUTLANDER 650 HO EFI 06	1142-0248
OUTLANDER 650 MAX HO EFI 06	1142-0248
TRAXTER 650 AUTO CVT 05	1142-0510
OUTLANDER 650 07-08	1142-0248
OUTLANDER 650 EFI 09-11, 13-15	1142-0248
OUTLANDER 650 EFI DPS 13-15	1142-0248
OUTLANDER 650 EFI XT 09, 13-15	1142-0248
OUTLANDER 650 HO EFI 08	1142-0248
OUTLANDER 650 X MR 13-15	1142-0248
OUTLANDER 650 XT 07-08	1142-0248
OUTLANDER MAX 650 EFI 09-11, 13-15	1142-0248
OUTLANDER MAX 650 EFI DPS 13-15	1142-0248
OUTLANDER MAX 650 EFI XT 09, 13-15	1142-0248
OUTLANDER 800 HO EFI 4X4 06	1142-0248
OUTLANDER MAX 800 HO EFI 06	1142-0248
OUTLANDER 800 HO EFI 08	1142-0248
OUTLANDER 800R EFI 09-12, 14-15	1142-0248
OUTLANDER 800R EFI DPS 13-15	1142-0248
OUTLANDER 800R EFI XT 09, 13-15	1142-0248
OUTLANDER 800R EFI XT-P 13-15	1142-0248
OUTLANDER 800R X MR 15	1142-0248
OUTLANDER MAX 800, LTD, XT 07-08	1142-0248
OUTLANDER MAX 800R EFI 09-14	1142-0248
OUTLANDER MAX 800R EFI DPS 13-15	1142-0248
OUTLANDER MAX 800R EFI XT 09, 13-15	1142-0248
OUTLANDER MAX 800R EFI XT-P 14-15	1142-0248
OUTLANDER MAX 800R LTD 09-11	1142-0248
RENEGADE 800 07-08	1142-0248
RENEGADE 800 HO EFI 08	1142-0248
RENEGADE 800 X 08	1142-0248
RENEGADE 800R EFI 09-15	1142-0248
RENEGADE 800R EFI X 09	1142-0248
RENEGADE 800R X XC 13-15	1142-0248
OUTLANDER 1000 EFI DPS 13-15	1142-0248
OUTLANDER 1000 EFI XT 13-15	1142-0248
OUTLANDER 1000 EFI XT-P 13-15	1142-0248
OUTLANDER 1000 X MR 13-15	1142-0248
OUTLANDER MAX 1000 EFI DPS 13-15	1142-0248
OUTLANDER MAX 1000 EFI LTD 13-15	1142-0248
OUTLANDER MAX 1000 EFI XT-P 13-15	1142-0248
RENEGADE 1000 EFI 12-15	1142-0248
RENEGADE 1000 X XC 13-15	1142-0248
OUTLANDER MAX 1000 EFI XT 13-15	1142-0248

FITS MODEL	PART #
HIGH PERFORMANCE PLUS DRIVE BELTS (CON'T)	
CAN-AM (CON'T)	
DEFENDER DPS 16-17	1142-0722
DEFENDER MAX DPS 17	1142-0722
DEFENDER MAX XT 17	1142-0722
DEFENDER XT 16-17	1142-0722
COMMANDER 800R 11-15	1142-0248
COMMANDER 800R DPS 13-15	1142-0248
COMMANDER 800R XT 11, 13-15	1142-0248
COMMANDER 1000 11-12, 14-17	1142-0248
COMMANDER 1000 DPS 14-17	1142-0248
COMMANDER 1000 LTD 14-17	1142-0248
COMMANDER 1000 X 11-12	1142-0248
COMMANDER 1000 XT 11-12, 14-17	1142-0248
COMMANDER 1000 XT-P 14-17	1142-0248
COMMANDER MAX 1000 DPS 14-17	1142-0248
COMMANDER MAX 1000 XT 14-17	1142-0248
MAVERICK 1000R 13-17	1142-0248
MAVERICK X3 TURBO R 17	1142-0722
CF MOTO	
CFORCE 500 13-14	1142-0517
CFORCE 600 13-14	1142-0517
UFORCE 600 13-14	1142-0517
ZFORCE 600 13-14	1142-0517
ZFORCE 600EX 13-14	1142-0517
CFORCE 800 14	1142-0520
UFORCE 800 14	1142-0520
ZFORCE 800EX 14	1142-0520
CFORCE 800 13	1142-0520
UFORCE 800 13	1142-0520
ZFORCE 800EX 13	1142-0520
JOHN DEERE	
BUCK 650 AUTO 06	1142-0510
TRAIL BUCK 650 04-05	1142-0510
KAWASAKI	
BRUTE FORCE 650 05-13	1142-0249
PRAIRIE 650 4X4 02-03	1142-0249
PRAIRIE 700 04-06	1142-0249
BRUTE FORCE 750 05-11	1142-0249
BRUTE FORCE 750 4X4 12-17	1142-0250
TERYX 750 08-14	1142-0250
MULE 3010 DIESEL 4X4 04-08	1142-0444
MULE 3010 TRANS 4X4 DIESEL 07-08	1142-0444
MULE 4010 4X4 DIESEL 09-13	1142-0444
MULE 4010 TRANS 4X4 DIESEL 09-13	1142-0444
TERYX 800 14	1142-0504
TERYX 800 4 14	1142-0504
TERYX 4 800 LE 14	1142-0504
TERYX 16-17	1142-0555
TERYX LE 16-17	1142-0555
TERYX4 16-17	1142-0555
TERYX4 LE 16-17	1142-0555
KYMCO	
MXU 450I CAMO 17	1142-0294
MXU 500 06-09	1142-0553
MXU 500 4X4 IRS 10-15	1142-0553
MXU 500I 15	1142-0553
MXU 500I 4X4 IRS 12-16	1142-0553
MXU 700I 15-16	1142-0553
MXU 700I 4X4 IRS 13, 15	1142-0553
MXU 700I 4X4 IRS LE 13-15	1142-0553
MXU500I 4X4 IRS LE 12-15	1142-0553
UXV 500 09-15	1142-0553
UXV 500 4X4 LE 10-11	1142-0553
UXV 500 4X4 SE 11	1142-0553
UXV 500I 15-16	1142-0553
UXV 500I 4X4 12-15	1142-0553
UXV 500I G 15	1142-0553
UXV 500I LE 12-15	1142-0553
UXV 500I SE 12-13	1142-0553
UXV 500I SP 13-14	1142-0553
UXV 500I HE 14,16	1142-0553
UXV 500I TURF 14-15	1142-0553
UXV 700I 14-16	1142-0553
UXV 700I LE 14-16	1142-0553
UXV 700I TURF 14-16	1142-0553

FITS MODEL	PART #
HIGH PERFORMANCE PLUS DRIVE BELTS (CON'T)	
POLARIS	
SPORTSMAN 450 HO 16-17	1142-0300
SPORTSMAN 500 EFI 08	1142-0300
SPORTSMAN 500 EFI X2 07-08	1142-0300
SPORTSMAN 500 HO 13	1142-0300
SPORTSMAN TOURING 500 EFI 08-13	1142-0300
SPORTSMAN X2 500 08	1142-0300
SPORTSMAN X2 500 EFI 08	1142-0300
SPORTSMAN 500 10-12	1142-0295
SPORTSMAN 550 13	1142-0521
SPORTSMAN 550 EPS 13-14	1142-0521
SPORTSMAN 550 TOURING EPS 10-12	1142-0295
SPORTSMAN 550 TOURING EPS 14	1142-0521
SPORTSMAN 550 X2 10-12	1142-0295
SPORTSMAN 550 X2 13-14	1142-0521
ACE 570 15	1142-0505
ACE 570 17	1142-0505
ACE 570 SP 16-17	1142-0420
SPORTSMAN 570 14-17	1142-0300
SPORTSMAN 570 TOURING 14-17	1142-0300
SPORTSMAN X2 570 EPS 15-17	1142-0300
SPORTSMAN 700 EFI 07-08	1142-0300
SPORTSMAN 800 10	1142-0300
SPORTSMAN 800 6X6 10	1142-0300
SPORTSMAN 800 6X6 BIG BOSS 14	1142-0300
SPORTSMAN 800 EFI 05-06	1142-0298
SPORTSMAN 800 EFI 07-08, 10-14	1142-0300
SPORTSMAN 800 EFI 6X6 09	1142-0300
SPORTSMAN 800 EFI TOURING 08	1142-0300
SPORTSMAN 800 EFI X2 07-08	1142-0300
SPORTSMAN 800 HO EFI 08-09	1142-0300
SPORTSMAN TOURING 800 EFI 09	1142-0300
SPORTSMAN BIG BOSS 6X6 800 11	1142-0300
SPORTSMAN 850 15-17	1142-0506
SPORTSMAN 850 HO TOURING EPS 14	1142-0506
SPORTSMAN 850 HO XP EPS 14	1142-0506
SPORTSMAN 850 SP 15	1142-0506
SPORTSMAN 850 SP 15-17	1142-0506
SPORTSMAN 850 TOURING EPS 10-11	1142-0295
SPORTSMAN 850 XP EPS 10-11	1142-0295
SPORTSMAN 850 XP EPS 13	1142-0300
SCRAMBLER 850 15-17	1142-0506
SPORTSMAN TOURING 850 H.O. EPS 12-13	1142-0295
SPORTSMAN TOURING 850 HO EPS 13	1142-0297
SPORTSMAN TOURING 850 SP 15-16	1142-0506
SPORTSMAN WV850 HO 14	1142-0506
SPORTSMAN XP 850 09	1142-0295
SPORTSMAN XP 850 HO 12-13	1142-0295
SPORTSMAN XP 850 HO 13	1142-0297
SPORTSMAN TOURING XP 1000 15-17	1142-0506
SPORTSMAN XP 1000 15-17	1142-0506
RANGER 4X4 07-09	1142-0298
RANGER ETX 15-16	1142-0505
ACE 500 17	1142-0505
RANGER 500 17	1142-0505
RANGER 500 EFI 11-13	1142-0300
RANGER CREW 500 11-13	1142-0300
RANGER DIESEL 11-14	1142-0484
RANGER DIESEL 15-17	1142-0507
RANGER DIESEL, CREW DIESEL 15-17	1142-0726
RANGER 570 (ALL) 14-15	1142-0505
RANGER 570 15-17	1142-0505
RANGER 570 EPS 15-16	1142-0505
RANGER CREW XP 570-6 16	1142-0505
RANGER XP 570 16	1142-0505
RANGER CREW 570-4 16-17	1142-0505
RANGER CREW 570-6 16-17	1142-0505
RZR 570 12-15	1142-0445
RANGER 6X6 07-08	1142-0298
RANGER 700 XP 09	1142-0298
RANGER 800 6X6 10-15	1142-0301
RANGER 800 EFI MID-SIZE 13-14	1142-0301
RANGER CREW 800 10-14	1142-0301
RANGER HD 800 11-12	1142-0301
RZR 4 800 13-14	1142-0301
RANGER XP 800 10-14	1142-0301
RZR 800 08-09,11	1142-0300

FITS MODEL	PART #
HIGH PERFORMANCE PLUS DRIVE BELTS (CON'T)	
POLARIS (CON'T)	
RZR 800 12-13	1142-0301
RZR 800 EPS 14	1142-0301
RZR 800 S 09	1142-0297
RANGER 900 CREW 14-15	1142-0420
RANGER 900 XP 13-16	1142-0420
RANGER 900 XP EPS 13-16	1142-0420
RANGER CREW 900-5 16	1142-0420
RANGER CREW 900-5 EPS 16	1142-0420
RANGER CREW 900-6, EPS 16	1142-0420
RANGER XP 900 17	1142-0420
RANGER CREW XP 900-5 16	1142-0420
RANGER CREW XP 900-6 16-17	1142-0420
RZR 4 900 EPS 14	1142-0420
RZR 4 900 EPS 15-17	1142-0518
RZR 900 & S 15	1142-0518
RZR 900 15-17	1142-0518
RZR 900 EPS 16	1142-0518
RZR 900 EPS TRAIL 15-16	1142-0518
RZR 900 EPS XC EDITION 17	1142-0518
RZR 900 XC EDITION 15-17	1142-0518
RANGER CREW XP 1000 17	1142-0554
RANGER XP 1000 17	1142-0554
RZR S 1000 EPS 16-17	1142-0511
RZR S 800 10-14	1142-0301
ACE 900 SP 16	1142-0420
ACE 14-15	1142-0420
ACE 900 XC 17	1142-0518
RZR S 900 EPS 15-17	1142-0518
RZR XP 1000 EPS 14-15	1142-0420
RZR XP 1000 EPS 15-17	1142-0511
RZR XP 4 1000 EPS 14	1142-0420
RZR XP 4 1000 EPS 15-17	1142-0511
RZR 1000 17	1142-0730
RZR XP 4 TURBO EPS 16-17	1142-0551
RZR XP 900 11	1142-0412
RZR XP 900 12-14	1142-0420
RZR XP TURBO EPS 16-17	1142-0551
GENERAL 1000 EPS 16-17	1142-0554
GENERAL 4 1000 EPS 17	1142-0554
SUZUKI	
KINGQUAD 400 14-16	1142-0250
KING QUAD 450 07-10	1142-0296
KINGQUAD 500 09,14	1142-0296
KING QUAD 700 05-07	1142-0271
KINGQUAD 750 08-14	1142-0271
TWIN PEAKS 700 04-06	1142-0249
YAMAHA	
BRUIN 350 4X4 AUTO 04	1142-0523
BRUIN 350 4X4 AUTO 05-06	1142-0250
GRIZZLY 350 AUTO 08-14	1142-0250
GRIZZLY 400 AUTO 4X4 07	1142-0523
KODIAK 400 4X4 AUTO 00-06	1142-0523
GRIZZLY 450 AUTO 4X4 07-14	1142-0523
KODIAK 450 4X4 AUTO 01-06	1142-0523
RHINO 450 AUTO 4X4 08-09	1142-0523
GRIZZLY 550 FI AUTO 4X4 EPS 09-14	1142-0519
GRIZZLY 600 4X4 AUTO 98-01	1142-0508
GRIZZLY 660 4X4 AUTO 02-08	1142-0299
RHINO 660 2004-2007	1142-0299
KODIAK 700 16-17	1142-0247
GRIZZLY 700 FI AUTO 4X4 11-12	1142-0519
GRIZZLY 700 FI AUTO 4X4 07-10, 13-17	1142-0247
RHINO 700 FI AUTO 4X4 08-12	1142-0247
WOLVERINE 16-17	1142-0488
WOLVERINE R-SPEC 16-17	1142-0488

SUSPENSION & DRIVE



HIGH PERFORMANCE DRIVE BELTS

Delivers unparalleled response. Constructed with extra strong p-aramid cord reinforcement and engineered fiber loaded neoprene compound. Delivers the "muscle" and durability demanded by today's high performance engines. Tested under severe field conditions, this belt has been proven to run cooler and provides longer belt life than competitive belts. Made in the USA.

FITS MODEL	PART #
HIGH PERFORMANCE DRIVE BELTS	
ARCTIC CAT	
550 11-12,14	1142-0414
550 CORE 13	1142-0414
550 GT 12	1142-0414
550 HI EFI 09-10	1142-0414
550 HI EFI LE 09-10	1142-0414
550 LTD 11, 13-14	1142-0414
550 S 10-11	1142-0414
550 S LTD 10	1142-0414
550 XT 13	1142-0414
TRV 550 11	1142-0414
TRV 550 CRUISER 11	1142-0414
TRV 550 GT 11	1142-0414
TRV 550 HI EFI 09-10	1142-0414
TRV 550 HI EFI LE 09	1142-0414
TRV 550 LIMITED 13-14	1142-0414
TRV 550 S GT 10	1142-0414
TRV 550 XT 13-14	1142-0414
TRV 550 XT EPS 15	1142-0414
TRV 550I CRUISER 12	1142-0414
TRV 550I GT 12	1142-0414
ALTERRA TRV 550 XT 17	1142-0414
650 HI 10-11	1142-0414
650 HI 4X4 AUTO 05-08	1142-0414
650 HI 4X4 AUTO LE 07	1142-0414
650 HI 4X4 AUTO TRV 07-08	1142-0414
650 HI 4X4 PROWLER 07	1142-0414
650 HI 4X4 PROWLER XT 07	1142-0414
650 HI 4X4 TBX 07	1142-0414
650 HI 4X4 TRV LE PLUS 07	1142-0414
TBX 650 09	1142-0414
TRV 650 HI 09	1142-0414
650 4X4 AUTO 04	1142-0245
650 4X4 AUTO LE 04,06	1142-0245
650 V2 4X4 AUTO 05-06	1142-0245
650 V2 4X4 AUTO LE 05-06	1142-0245
MUD PRO 650 HI 10-11	1142-0414
700 12, 14	1142-0414
700 CORE 13	1142-0414
700 GT 12	1142-0414
700 HI EFI 09-11	1142-0414
700 HI EFI 4X4 TBX SE 08	1142-0414
700 HI EFI LE 09-10	1142-0414
700 HI EFI MUD PRO 09	1142-0414
700 HI EFI SE 09	1142-0414
700 LTD 11-14	1142-0414
700 MUD PRO LTD 12	1142-0414
700 S 10-11	1142-0414
700 XT 13-14	1142-0414
MUD PRO 700 HI EFI 10-12	1142-0414
MUDPRO 700 LIMITED 13-14	1142-0414
MUDPRO 700I 12	1142-0414
ALTERRA 700 17	1142-0414
ALTERRA TRV 700 XT 17	1142-0414
HDX 700 XT 17	1142-0414
PROWLER 700 XT EPS 17	1142-0414
TBX 700 HI EFI 10	1142-0414
TBX 700 LTD 11	1142-0414
TBX 700 XT 13	1142-0414

FITS MODEL	PART #
HIGH PERFORMANCE DRIVE BELTS (CON'T)	
ARCTIC CAT (CON'T)	
TBX 700I GT 12	1142-0414
TRV 700 11	1142-0414
TRV 700 CRUISER 11	1142-0414
TRV 700 GT 11	1142-0414
TRV 700 HI EFI 10	1142-0414
TRV 700 HI EFI CRUISER 09-10	1142-0414
TRV 700 LIMITED 13-14	1142-0414
TRV 700 LIMITED EPS 15	1142-0414
TRV 700 S GT 10	1142-0414
TRV 700 XT 14-15	1142-0414
TRV 700I GT 12	1142-0414
TVR 700I CRUISER 12	1142-0414
700 EFI 4X4 AUTO 06-08	1142-0246
700 EFI 4X4 AUTO LE 07-08	1142-0246
700 EFI 4X4 AUTO TRV LE 08	1142-0246
700 EFI CRUISER 08	1142-0246
PROWLER 550 HI EFI 09	1142-0414
PROWLER 650 4X4 AUTO 08	1142-0414
PROWLER 650 4X4 AUTO M4 08	1142-0414
PROWLER 700 HDX 13	1142-0414
PROWLER 700 XT 13-14	1142-0414
PROWLER HDX 700 11-12	1142-0414
PROWLER HDX 700 LIMITED 14	1142-0414
PROWLER XT 550 10-14	1142-0414
PROWLER XT 650 HI 09	1142-0414
PROWLER XT 700 HI EFI 09	1142-0414
PROWLER XT 700 10-12	1142-0414
PROWLER XT 700 HI EFI LE 08-09	1142-0414
PROWLER XT 700 HI LE 08-09	1142-0414
CAN-AM	
OUTLANDER 450 L 15	1142-0244
OUTLANDER 450 L DPS 15	1142-0244
OUTLANDER 450 L MAX 15	1142-0244
OUTLANDER 500 07-08	1142-0244
OUTLANDER 500 EFI 09-14	1142-0244
OUTLANDER 500 EFI DPS 13-15	1142-0244
OUTLANDER 500 EFI XT 09, 13-15	1142-0244
OUTLANDER 500 XT 07-08	1142-0244
OUTLANDER MAX 500 EFI 09-14	1142-0244
OUTLANDER MAX 500 EFI DPS 13-15	1142-0244
OUTLANDER MAX 500 EFI LTD 09	1142-0244
OUTLANDER MAX 500 EFI XT 09, 13-15	1142-0244
RENEGADE 500 08	1142-0244
RENEGADE 500 EFI 09-15	1142-0244
OUTLANDER 570 17	1142-0244
OUTLANDER 650 HO EFI 06	1142-0244
OUTLANDER 650 HO EXI XT 06	1142-0244
OUTLANDER 650 MAX HO EFI 06	1142-0244
OUTLANDER 650 MAX HO EXI XT 06	1142-0244
OUTLANDER 650 07-08	1142-0244
OUTLANDER 650 EFI 09-11, 13-15	1142-0244
OUTLANDER 650 EFI DPS 13-15	1142-0244
OUTLANDER 650 EFI XT 09, 13-15	1142-0244
OUTLANDER 650 HO EFI 08	1142-0244
OUTLANDER 650 X MR 13-15	1142-0244
OUTLANDER 650 XT 07-08	1142-0244
OUTLANDER MAX 650 EFI 09-11, 13-15	1142-0244
OUTLANDER MAX 650 EFI DPS 13-15	1142-0244
OUTLANDER MAX 650 EFI XT 09, 13-15	1142-0244
OUTLANDER 800 HO EFI 4X4 06	1142-0244
OUTLANDER MAX 800 HO EFI 06	1142-0244
OUTLANDER 800 HO EFI 08	1142-0244
OUTLANDER 800R EFI 09-12, 14-15	1142-0244
OUTLANDER 800R EFI DPS 13-15	1142-0244
OUTLANDER 800R EFI XT 09, 13-15	1142-0244
OUTLANDER 800R EFI XT-P 13-15	1142-0244
OUTLANDER MAX 800 07-08	1142-0244
OUTLANDER MAX 800 LTD 07-08	1142-0244
OUTLANDER MAX 800 XT 07-08	1142-0244
OUTLANDER MAX 800R EFI 09-14	1142-0244
OUTLANDER MAX 800R EFI DPS 13-15	1142-0244
OUTLANDER MAX 800R EFI XT 09, 13-15	1142-0244
OUTLANDER MAX 800R EFI XT-P 14-15	1142-0244
OUTLANDER MAX 800R LTD 09-11	1142-0244
COMMANDER MAX 1000 DPS 14-15	1142-0244
COMMANDER MAX 1000 XT 14-15	1142-0244

FITS MODEL	PART #
HIGH PERFORMANCE DRIVE BELTS (CON'T)	
CAN-AM (CON'T)	
OUTLANDER 1000X MR 12	1142-0244
COMMANDER 1000 14-15	1142-0244
COMMANDER 1000 DPS 14-15	1142-0244
COMMANDER 1000 LTD 14-15	1142-0244
COMMANDER 1000 XT 14-15	1142-0244
COMMANDER 1000 XT-P 14-15	1142-0244
COMMANDER 800R 11-15	1142-0244
COMMANDER 800R DPS 13-15	1142-0244
COMMANDER 800R XT 11, 13-15	1142-0244
KAWASAKI	
PRAIRIE 360 04-09	1142-0245
PRAIRIE 360 4X4 04-13	1142-0245
BRUTE 650 05	1142-0245
BRUTE FORCE 650 06-08	1142-0245
BRUTE FORCE 650 4X4 05-13	1142-0245
BRUTE FORCE 650 4X4I 06-13	1142-0245
PRAIRIE 700 04-05	1142-0245
PRAIRIE 700 4X4 04-06	1142-0245
BRUTE FORCE 750 05-09	1142-0245
BRUTE FORCE 750 4X4I 05-11	1142-0245
POLARIS	
TRAIL BOSS 250 94-99	1142-0239
TRAIL BLAZER 250 94-05	1142-0239
TRAIL BOSS 300 2X4 95	1142-0239
TRAIL BOSS 300 4X4 95	1142-0239
XPRESS 300 96-99	1142-0239
TRAIL BOSS 325 99-02	1142-0239
TRAIL BOSS 330 03-13	1142-0239
XPLORER 300 96-99	1142-0239
XPLORER 400 95-02	1142-0239
XPLORER 4X4 01-02	1142-0239
300 2X4 94-95	1142-0239
300 4X4 94-95	1142-0239
BIG BOSS 300 6X6 94	1142-0239
MAGNUM 325 2X4 00-02	1142-0239
MAGNUM 325 4X4 00-02	1142-0239
ATP 330 04-05	1142-0239
MAGNUM 330 2X4 03-05	1142-0239
MAGNUM 330 4X4 03-06	1142-0239
TRAIL BLAZER 330 08-13	1142-0239
SPORTSMAN 335 98	1142-0242
XPRESS 400L 96-97	1142-0239
SPORTSMAN 335 99-00	1142-0239
400L 2X4 94-95	1142-0239
400L 4X4 94	1142-0239
TRAIL BLAZER 400 03	1142-0239
BIG BOSS 400L 6X6 94-97	1142-0239
SPORTSMAN 400 95-96, 02-05, 12	1142-0239
SPORTSMAN 400 HO 11, 13-14	1142-0239
SPORTSMAN 400 HO 4X4 11-12	1142-0239
SPORTSMAN 400L 97	1142-0239
MAGNUM 425 2X4 95-98	1142-0239
MAGNUM 425 4X4 95-97	1142-0239
MAGNUM 425 6X6 96-97	1142-0239
MAGNUM 425 4X4 98	1142-0242
SPORTSMAN 450 06-07	1142-0239
SPORTSMAN 450 HO 16-17	1142-0241
BIG BOSS 500 6X6 99	1142-0239
MAGNUM 500 00	1142-0239
SPORTSMAN 500 96-97	1142-0239
SPORTSMAN 500 EFI 07	1142-0239
SPORTSMAN 500 HO 01-02, 06, 08-12	1142-0239
SPORTSMAN 500 6X6 00-08	1142-0239
SPORTSMAN ETX 15	1142-0239
TRAIL BLAZER 06	1142-0239
XPRESS 500 4X4 97	1142-0239
SPORTSMAN 500 EFI 08	1142-0241
SPORTSMAN 500 EFI TOURING 08	1142-0241
SPORTSMAN 500 EFI X2 07-08	1142-0241
SPORTSMAN 500 HO 13	1142-0241
SPORTSMAN 500 HO EFI 08	1142-0241
SPORTSMAN 500 HO TOURING 10-13	1142-0241
SPORTSMAN 500 98-99	1142-0242
SPORTSMAN 500 EFI 06	1142-0242
SPORTSMAN 500 HO 03-05	1142-0242
SPORTSMAN 500 HO W/EBS 01-02	1142-0242

FITS MODEL	PART #
HIGH PERFORMANCE DRIVE BELTS (CON'T)	
POLARIS (CON'T)	
SPORTSMAN 500 W/EBS 00-02	1142-0242
SPORTSMAN TOURING 500 EFI 09	1142-0241
SPORTSMAN TOURING 500 H.O. 11	1142-0241
X2 500 EFI 07-08	1142-0241
BIG BOSS 500 6X6 98	1142-0242
DIESEL 500 99	1142-0242
MAGNUM 500 4X4 99	1142-0242
MAGNUM 500 W/EBS 00-02	1142-0242
SPORTSMAN 570 14-17	1142-0241
SPORTSMAN 570 EPS 14-17	1142-0241
SPORTSMAN 570 SP 15-17	1142-0241
SPORTSMAN 570 TOURING 14-17	1142-0241
SPORTSMAN 570 17	1142-0241
SPORTSMAN X2 570 EPS 15-17	1142-0241
SPORTSMAN TOURING 570 SP 15-17	1142-0241
SPORTSMAN 700 EFI X2 08	1142-0241
SPORTSMAN 700 02-06	1142-0242
SPORTSMAN 700 EFI 04-06	1142-0242
SPORTSMAN 800 EFI 05-06	1142-0240
SPORTSMAN 800 10	1142-0241
SPORTSMAN 800 6X6 10	1142-0241
SPORTSMAN 800 6X6 BIG BOSS 14	1142-0241
SPORTSMAN 800 EFI 08, 10-14	1142-0241
SPORTSMAN 800 EFI 6X6 09	1142-0241
SPORTSMAN 800 EFI TOURING 08	1142-0241
SPORTSMAN 800 EFI X2 07-08	1142-0241
SPORTSMAN 800 HD EFI 08-09	1142-0241
SPORTSMAN 850 XP EPS 13	1142-0241
SPORTSMAN BIG BOSS 6X6 800 11	1142-0241
SPORTSMAN TOURING 800 EFI 09	1142-0241
SPORTSMAN X2 08	1142-0241
X2 800 EFI 07	1142-0241
SPORTSMAN 600 03-05	1142-0242
SPORTSMAN X2 06	1142-0242
RANGER 2X4 04, 07	1142-0239
RANGER 400 11-14	1142-0239
RANGER 4X4 04-05, 07, 09	1142-0239
RANGER 6X6 04-05	1142-0239
RANGER 6X6 500 98-99	1142-0239
RANGER SERIES 10 425 2X4 03	1142-0239
RANGER SERIES 10 500 4X4 03	1142-0239
RANGER SERIES 10 500 6X6 03	1142-0239
RANGER 4X4 07-09	1142-0240
RANGER 6X6 07-08	1142-0240
RANGER HD 09	1142-0240
RANGER XP 09	1142-0240
RANGER 500 EFI 11-13	1142-0241
RANGER 500 EFI LE 12	1142-0241
RANGER CREW 500 12	1142-0241
RANGER CREW 500 EFI 11, 13	1142-0241
RANGER RZR 08-09	1142-0241
RANGER RZR 800 11	1142-0241
SUZUKI	
KING QUAD 700 05-07	1142-0246
KINGQUAD 750 AXI 08-10	1142-0246
KINGQUAD 750 AXI LIMITED EDITION 08-09	1142-0246
TWIN PEAKS 700 04-06	1142-0245
YAMAHA	
GRIZZLY 660 4X4 AUTO 02-08	1142-0243
RHINO 660 04-07	1142-0243

FRONT AND REAR SHOCK BUSHING KITS

OEM replacement parts designed to rebuild the shock to factory specification. Kit contains bearings, seals, spacers and pins.



FITS MODEL	FRONT PART #	REAR PART #
FRONT AND REAR SHOCK BUSHING KITS		
ARCTIC CAT		
250 2X4 99-05	1313-0027	1313-0027
250 2X4 06-09	-	1313-0027
250 4X4 01-05	1313-0027	1313-0027
300 2X4 98-04	1313-0027	1313-0027
300 4X4 98-05	1313-0027	1313-0027
375 2X4 W/AT 02	1313-0027	1313-0027
375 4X4 W/AT 02	1313-0027	1313-0027
400 2X4 98-01	1313-0027	1313-0027
400 2X4 FIS W/AT 03-04	1313-0027	1313-0027
400 2X4 FIS W/MT 03-04	1313-0027	1313-0027
400 4X4 98-00	1313-0027	1313-0027
400 4X4 W/AT 03-04	1313-0027	1313-0027
400 4X4 W/MT 01-04	1313-0027	1313-0027
400 FIS 4X4 W/AT 03-06	1313-0027	1313-0027
400 FIS 4X4 W/MT 02-06	1313-0027	1313-0027
400 TBX 4X4 04-06	1313-0027	1313-0027
400 VP 4X4 06	1313-0027	1313-0027
454 2X4 97-98	1313-0027	1313-0027
454 4X4 96-98	1313-0027	1313-0027
500 4X4 98-99	1313-0027	1313-0027
500 4X4 W/AT 00-02	1313-0027	1313-0027
500 4X4 W/MT 00-01	1313-0027	1313-0027
500 FIS 4X4 W/AT 02-06	1313-0027	1313-0027
500 FIS 4X4 W/MT 02	1313-0027	1313-0027
500 FIS 4X4 W/MT 04-06	1313-0027	1313-0027
500 FIS TBX 4X4 02-06	1313-0027	1313-0027
500 FIS TRV 4X4 03-06	1313-0027	1313-0027
650 4X4 H1 05-06	1313-0027	1313-0027
650 4X4 W/AT V2 04-06	1313-0027	1313-0027
HONDA		
TRX350FE 00-06	1313-0031	-
TRX350FM RANCHER 00-01	1313-0031	-

FITS MODEL	PART #	PART #
FRONT AND REAR SHOCK BUSHING KITS (CON'T)		
HONDA (CON'T)		
TRX350FM RANCHER 02-06	1313-0031	-
TRX350TE 00-01	1313-0031	-
TRX350TE 02-06	1313-0031	-
TRX350TM RANCHER 00-01	1313-0031	-
TRX350TM RANCHER 02-06	1313-0031	-
TRX400EX 99-04	1313-0029	-
TRX400FA 04-07	1313-0031	-
TRX400FGA RANCHER 4X4 04-07	1313-0031	-
TRX420 FA/FPA 09-14	1313-0121	-
TRX420 FE/FM 07-13	1313-0121	1313-0122
TRX420 FPE/FPM 11-13	1313-0121	1313-0122
TRX420 TE/TM 07-13	1313-0121	1313-0122
TRX450ES 98-01	1313-0030	-
TRX450FE/FM 02-04	1313-0030	-
TRX450S 98-01	1313-0030	-
TRX450ER 06-09	1313-0003	-
TRX450ER 12-14	1313-0003	-
TRX450R 04-09	1313-0003	-
TRX500FA 01-06	1313-0010	1313-0010
TRX500FA 07-14	1313-0031	1313-0031
TRX500FE 05-06	1313-0010	1313-0010
TRX500FE 07	1313-0031	1313-0010
TRX500FE 08-11	1313-0031	1313-0031
TRX500FE 12-13	1313-0031	-
TRX500FGA 04-06	1313-0010	1313-0010
TRX500FGA 07-09	1313-0031	1313-0031
TRX500FM 05-06	1313-0010	1313-0010
TRX500FM 07-11	1313-0031	1313-0031
TRX500FM 12-13	1313-0031	1313-0123
TRX500FPA 09-13	1313-0031	1313-0031
TRX500FPE 08-11	1313-0031	1313-0031
TRX500FPE 12-13	1313-0031	1313-0123
TRX500FPM 08-11	1313-0031	1313-0031
TRX500FPM 12-13	1313-0031	1313-0123
TRX500TM 05-06	1313-0010	1313-0010
TRX650 RINCON 03-05	1313-0010	-
TRX680 RINCON 06-17	1313-0010	-
KAWASAKI		
KVF650 I BRUTE FORCE 06-13	1313-0153	1313-0153
KVF750 BRUTE FORCE 05-17	1313-0153	1313-0153
KVF750 BRUTE FORCE EPS 12-17	1313-0153	1313-0153



SUSPENSION & DRIVE

WHEEL BEARING KITS

Includes all bearings and seals required to rebuild one wheel. EMQ premium-quality, high-speed bearings feature double-lip rubber seals. Specifically designed to keep out dirt and water while providing superior grease retention. Seals contain a garter-spring inner lip that guarantees an optimum seal.



FITS MODEL	FRONT KIT PART #	QTY	REAR KIT PART #	QTY
WHEEL BEARING KITS				
ARCTIC CAT				
50 2X4 08	0215-0151	2	0215-0224	1
50 Y-6 YOUTH 04-06	0215-0151	2	0215-0077	1
90 UTILITY 07-13	0215-0151	2	0215-0077	1
90 Y-12 YOUTH 02-06	0215-0151	2	0215-0077	1
250 2X4 99-05	0215-0076	2	0215-0076	2
250 2X4 06-09	A25-1035	2	-	-
250 4X4 01-04	0215-0076	2	0215-0076	2
250 4X4 05	0215-0153 ¹	2	0215-0153 ¹	2
300 2X4 98-04	0215-0076	2	0215-0076	2
300 2X4 10-15	A25-1035	2	0215-1007	-
300 4X4 98-04	0215-0076	2	0215-0076	2
300 4X4 05	0215-0153 ¹	2	0215-0153 ¹	2
366 FIS W/ AT 08-10	0215-0153 ¹	2	0215-0153 ¹	2
375 02	0215-0076	2	0215-0081	1
400 98-00	0215-0076	2	0215-0080	1
400 01-04	0215-0076	2	0215-0081	1
400 FIS 02-04	0215-0076	2	0215-0076	2
400 FIS 05-08	0215-0153 ¹	2	0215-0153 ¹	2
400 FIS 4X4 TRV 09-13	0215-0153 ¹	2	0215-0153 ¹	2
400 TBX 4X4 04	0215-0076	2	0215-0076	2
400 TBX 4X4 05-06	0215-0153 ¹	2	0215-0153 ¹	2
400 TRV 07	0215-0153 ¹	2	0215-0153 ¹	2
400 VP 4X4 06	0215-0153 ¹	2	0215-0153 ¹	2
425 4X4 11-12	0215-0153 ¹	2	0215-0153 ¹	2
450 H1 10-11	0215-0153 ¹	2	0215-0153 ¹	2
450 4X4 14-15	0215-0153 ¹	2	0215-0153 ¹	2
454 96-98	0215-0076	2	0215-0080	1
500 EFI	0215-0153 ¹	2	0215-0153 ¹	2
500 TRV	0215-0153 ¹	2	0215-0153 ¹	2
500 XT EFI	0215-0153 ¹	2	0215-0153 ¹	2
550 EFI 4X4	0215-0153 ¹	2	0215-0153 ¹	2
500 4X4 98-99	0215-0076	2	0215-0080	1
500 4X4 00 (W/ VIN 4UF00AT86YT311795 AND LOWER)	0215-0076	2	0215-0081	1
500 4X4 00 (W/ VIN 4UF00AT86YT311796 AND HIGHER)	0215-0076	2	0215-0081	1
500 4X4 01-02	0215-0076	2	0215-0081	1
500 FIS 4X4 02-04	0215-0076	2	0215-0076	2
500 FIS 4X4 05-09	0215-0153 ¹	2	0215-0153 ¹	2
500 FIS TBX 4X4 02	0215-0076	2	0215-0081	1
500 FIS TBX 4X4 03-04	0215-0076	2	0215-0076	2
500 FIS TBX 4X4 05-06	0215-0153 ¹	2	0215-0153 ¹	2
500 FIS TRV 4X4 03-04	0215-0076	2	0215-0076	2
500 FIS TRV 4X4 05-08	0215-0153 ¹	2	0215-0153 ¹	2
550 H1 EFI 11	0215-0153 ¹	2	0215-0153 ¹	2
550 H1 FIS 4X4 W/ MT 09-10	0215-0153 ¹	2	0215-0153 ¹	2
550 LTD EFI 11	0215-0153 ¹	2	0215-0153 ¹	2
550 TRV 11-13	0215-0153 ¹	2	0215-0153 ¹	2
550 TRV 4X4 W/ AT 09-10	0215-0153 ¹	2	0215-0153 ¹	2
550 PROWLER XT 09-13	0215-0153 ¹	2	0215-0153 ¹	2
650 4X4 H1 05-10	0215-0153 ¹	2	0215-0153 ¹	2
650 4X4 W/ AT V2 04	0215-0076	2	0215-0153 ¹	2
650 4X4 W/ AT V2 05-06	0215-0153 ¹	2	0215-0153 ¹	2
650 PROWLER XT 06-09	0215-0153 ¹	2	0215-0153 ¹	2
700 DIESEL 08-15	0215-0153 ¹	2	0215-0153 ¹	2
700 EFI 4X4 07-12	0215-0153 ¹	2	0215-0153 ¹	2
700 EFI H1 MUDPRO 09-10	0215-0153 ¹	2	0215-0153 ¹	2
700 EFI H1 W/ AT 08-10	0215-0153 ¹	2	0215-0153 ¹	2
700 H1 TRV 11	0215-0153 ¹	2	0215-0153 ¹	2
700 LTD 11	0215-0153 ¹	2	0215-0153 ¹	2
700 TRV 08	0215-0153 ¹	2	0215-0153 ¹	2
700 PROWLER XT 08-13	0215-0153 ¹	2	0215-0153 ¹	2
1000 CRUISER 12	0215-0153 ¹	2	0215-0153 ¹	2
1000 TRV GT 12	0215-0153 ¹	2	0215-0153 ¹	2
1000 TRV LTD 13	0215-0153 ¹	2	0215-0153 ¹	2

FITS MODEL	FRONT KIT PART #	QTY	REAR KIT PART #	QTY
WHEEL BEARING KITS (CON'T)				
ARCTIC CAT (CON'T)				
1000 XT 13	0215-0153 ¹	2	0215-0153 ¹	2
1000I GT 12	0215-0153 ¹	2	0215-0153 ¹	2
1000I LDT EFI MUDPRO 12-13	0215-0153 ¹	2	0215-0153 ¹	2
1000 H2 MUDPRO 10	0215-0153 ¹	2	0215-0153 ¹	2
1000 H2 THUNDERCAT 08-10	0215-0153 ¹	2	0215-0153 ¹	2
550 PROWLER 09-13	0215-0153 ¹	2	0215-0153 ¹	2
700 PROWLER HDX 12-16	0215-0153 ¹	2	0215-0153 ¹	2
700 PROWLER XTX 08-16	0215-0153 ¹	2	0215-0153 ¹	2
1000 PROWLER XTX 11-13	0215-0153 ¹	2	0215-0153 ¹	2
WILDCAT GT 12-15	0215-0153 ¹	2	0215-0153 ¹	2
WILDCAT LIMITED 13	0215-0153 ¹	2	0215-0153 ¹	2
CAN-AM				
RALLY 175 03-07	0215-0152	2	0215-0156	1
OUTLANDER 330 04-05	0215-0167	2	-	-
OUTLANDER 400 03-05	0215-0167	2	-	-
OUTLANDER 400 06-14	0215-0165	2	0215-0165	2
OUTLANDER L 450 EFI 15	0215-0165	2	0215-0165	2
OUTLANDER 500 07-14	0215-0165	2	0215-0165	2
OUTLANDER 500 POWER STEERING 10-12	0215-0165	2	0215-0165	2
QUEST 500 02-03	0215-0244	2	-	2
RENEGADE 500 08-13	0215-0165	2	0215-0165	2
TRAXTER 500 99-01	0215-0243	2	-	-
TRAXTER 500 02-05	0215-0244	2	-	-
OUTLANDER 650 07-14	0215-0165	2	0215-0165	2
OUTLANDER 650 POWER STEERING 10-12	0215-0165	2	0215-0165	2
QUEST 650 02-04	0215-0244	2	-	-
TRAXTER 650 04-05	0215-0244	2	-	-
OUTLANDER 800 06-14	0215-0165	2	0215-0165	2
OUTLANDER 800 POWER STEERING 10-12	0215-0165	2	0215-0165	2
RENEGADE 800 07-14	0215-0165	2	0215-0165	2
RENEGADE 800 POWER STEERING 10-12	0215-0165	2	0215-0165	2
OUTLANDER 1000 12-14	0215-0165	2	0215-0165	2
RENEGADE 1000 12-15	0215-0165	2	0215-0165	2
COMMANDER 800 11-15	0215-0165	2	0215-0165	2
COMMANDER 1000 11-15	0215-0165	2	0215-0165	2
MAVERICK 1000 13-16	0215-0165	2	0215-0165	2
MAVERICK X3 17	0215-1061	2	0215-1061	2
CF MOTO				
ATV 500 (ALL)	0215-0153 ¹	2	0215-0153 ¹	2
CF500 07-14	0215-0153 ¹	2	0215-0153 ¹	2
TERRACROSS (ALL)	0215-0153 ¹	2	-	2
X5 TERRALANDER 500 11-14	0215-0153 ¹	2	0215-0153 ¹	2
X-LANDER (ALL)	0215-0153 ¹	2	0215-0153 ¹	2
Z6 TERRACROSS 600 11-14	0215-0153 ¹	2	-	2
X6 TERRALANDER 625 EFI 11-13	0215-0153 ¹	2	0215-0153 ¹	2
X6 TERRALANDER 625 EFI 14	0215-0153 ¹	2	0215-0153 ¹	2
Z6-EX TERRACROSS 625 EX 12-14	0215-0153 ¹	2	-	2
TRACKER 800 CF800-3 UTV 13-14	0215-0153 ¹	2	-	2
X8 TERRALANDER 800 12-14	0215-0153 ¹	2	0215-0153 ¹	2
Z8-EX TERRACROSS 800 EX 14	0215-0153 ¹	2	-	2
RANCHER 500 CF500-5 UTV 11-13	-	2	0215-0153 ¹	2
UTV 500 (ALL)	-	2	0215-0153 ¹	2
RANCHER 600 CF600-5 UTV 11-13	-	2	0215-0153 ¹	2
E-TON				
IXL-40 RASCAL	0215-0151	2	-	-
RXL-40	0215-0151	2	-	-
AXL-50	0215-0151	2	-	-
NXL-50	0215-0151	2	-	-
RXL50	0215-0151	2	-	-
TXL 50	0215-0151	2	-	-
RX4-70	0215-0151	2	-	-
RXL 70	0215-0151	2	-	-
AXL 90	0215-0151	2	-	-
NXL-90	0215-0151	2	-	-
RX4-90R	0215-0151	2	-	-
RXL 90	0215-0151	2	-	-
TXL90	0215-0151	2	-	-
CXL-150	A25-1063	2	-	-
RXL150	A25-1063	2	-	-
YXL150	A25-1063	2	-	-
HONDA				
ATC70 73-77	A25-1187	1	-	-
ATC70 78-85	A25-1187	1	A25-1108	1
TRX70 86-87	A25-1050	2	A25-1108	1
TRX90 93-16	A25-1052	2	A25-1029	1

FITS MODEL	FRONT KIT PART #	QTY	REAR KIT PART #	QTY
WHEEL BEARING KITS (CON'T)				
HONDA (CON'T)				
ATC110 79-81	-	-	A25-1122	1
ATC110 82-85	A25-1317	1	A25-1122	1
ATC125M 84-85	A25-1317	1	A25-1122	1
ATC125M 86-87	A25-1317	1	A25-1032	1
TRX125 85-86	A25-1052	2	A25-1122	1
TRX125 87-88	A25-1052	2	A25-1032	1
ATC185 80-83	A25-1317	1	A25-1122	1
ATC200E 82-83	A25-1317	1	A25-1122	1
ATC200ES 84	A25-1317	1	-	-
ATC200M, S 84-86	A25-1317	1	A25-1122	1
ATC200X 83-85	A25-1317	1	A25-1122	1
ATC200X 86-87	A25-1317	1	-	-
TRX200 84	A25-1112	2	-	-
TRX200 90-97	0215-0163	2	A25-1124	1
TRX200D 90-97	0215-0163	2	A25-1124	1
ATC250ES 85	A25-1317	1	A25-1019	1
ATC250ES 86-87	A25-1317	1	A25-1036	1
ATC250SX 85	A25-1317	1	A25-1019	1
ATC250SX 86-87	A25-1317	1	A25-1036	1
FL250 77-84	A25-1070	2	-	-
TRX250 FOURTRAX 85-87	A25-1112	2	A25-1036	1
TRX250 RECON 97-16	0215-0163	2	A25-1034	1
TRX300 FOURTRAX 300 88-92	A25-1035	2	A25-1123	1
TRX300 FOURTRAX 300 93-00	A25-1112	2	A25-1123	1
TRX300FW FOURTRAX 4X4 88-00	A25-1003	2	A25-1123	1
ATC350X 85-86	A25-1317	2	A25-1320	1
FL350 85	A25-1112	2	-	-
TRX350 86	-	-	A25-1036	1
TRX350 87	A25-1004	2	A25-1036	1
TRX350D 87-89	A25-1004	2	A25-1036	1
TRX350FE/FM 00-06	0215-0164	2	A25-1037	1
TRX350TE/TM 00-06	0215-0163	2	A25-1037	1
TRX400FA/FGA 04-07	0215-0164	2	A25-1037	1
TRX400FW FOURTRAX FOREMAN 4X4 95-03	A25-1005	2	A25-1037	1
TRX420 FA/FPA 09-13	A25-1003	2	0215-0737	1
TRX420 FE/FM 07-13	A25-1003	2	0215-0250	1
TRX420 TE/TM 07-13	0215-0200	2	0215-0250	1
TRX420 FE/FM 14-17	0215-0959	2	0215-0960	1
TRX420 TE/TM 14-17	0215-0959	2	0215-0960	1
TRX420 FE/FM 14-17	0215-0959	2	0215-0960	1
TRX420 TE/TM 14-17	0215-0959	2	0215-0960	1
TRX450ES 98-01	A25-1005	2	A25-1037	1
TRX450FE/FM 02-04	A25-1005	2	A25-1037	1
TRX450S 98-01	A25-1005	2	A25-1037	1
TRX500FA 01-04	A25-1005	2	A25-1037	1
TRX500FGA 04	A25-1005	2	A25-1037	1
TRX500FA/FE/FGA 05-13	0215-0249	2	A25-1037	1
TRX500FM/FPA 05-13	0215-0249	2	A25-1037	1
TRX500FPE/FPM 08-13	0215-0249	2	A25-1037	1
TRX500FE/FM 14	0215-0959	2	0215-0960	2
TRX500FPE/FM 14	0215-0959	2	0215-0960	2
TRX500TM 05-06	0215-0200	2	A25-1037	1
TRX650 RINCON 03-05	A25-1005	2	0215-0155	2
TRX680 RINCON 06-14	0215-0249	2	0215-0155	2
BIG RED MUV 700 09-13	0215-1005	2	0215-1005	2
PIONEER 500 15	0215-1003	2	0215-1004	2
PIONEER 700 14-16	0215-1003	2	0215-1031	2
PIONEER 700-4 14-16	0215-1003	2	0215-1031	2
PIONEER 700 SXS700M2 15-16	0215-1003	2	0215-1031	2
PIONEER 700-4 SXS700M4 15-16	0215-1003	2	0215-1031	2
PIONEER 1000 SXS 16	0215-1031	2	0215-1031	2
JOHN DEERE				
4X2 GATOR DIESEL GATOR TRAIL GATOR WORKSITE GATOR (ALL)	0215-1023	-	-	-
4X2 HPX GATOR UTILITY VEHICLE DIESEL ABOVE 040001 (ALL)	0215-1025	-	-	-
4X2 HPX GATOR UTILITY VEHICLE DIESEL UP TO 040000 (ALL)	0215-1025	-	-	-
4X2 HPX GATOR UTILITY VEHICLE GAS (ALL)	0215-1025	-	-	-
4X4 HPX 4X4 TRAIL HPX GATOR UTILITY VEHICLE GAS (ALL)	0215-1025	-	-	-
4X4 HPX GATOR UTILITY VEHICLE DIESEL ABOVE 040001 (ALL)	0215-1025	-	-	-
4X4 HPX GATOR UTILITY VEHICLE DIESEL UP TO 040000 (ALL)	0215-1025	-	-	-

FITS MODEL	FRONT KIT PART #	QTY	REAR KIT PART #	QTY
WHEEL BEARING KITS (CON'T)				
JOHN DEERE (CON'T)				
6X4 GATOR DIESEL GATOR TRAIL GATOR WORKSITE GATOR (ALL)	0215-1023	-	-	-
6X4 GATOR GAS GATOR TRAIL GATOR WORKSITE GATOR (ALL)	0215-1023	-	-	-
A3 T MILITARY GATOR UTILITY VEHICLE (ALL)	0215-1026	-	0215-1026	-
CS AND CX GATOR UTILITY VEHICLE (ALL)	0215-1023	-	0215-1024	-
E-GATOR UTILITY VEHICLE ELECTRIC TURF (ALL)	0215-1023	-	-	-
GATOR TURF (4X2) (ALL)	0215-1023	-	-	-
MILITARY 4X4 GATOR A2 UTILITY VEHICLE M-GATOR (ALL)	0215-1023	-	-	-
MILITARY 4X4 GATOR A3 UTILITY VEHICLE M-GATOR (ALL)	0215-1026	-	0215-1026	-
MILITARY 6X4 GATOR (M-GATOR) UTILITY VEHICLE (ALL)	0215-1023	-	-	-
MILITARY 6X4 GATOR A1 UTILITY VEHICLE M-GATOR (ALL)	0215-1023	-	-	-
TE GATOR UTILITY VEHICLE (ALL)	0215-1023	-	-	-
TH 6X4 GATOR UTILITY VEHICLE DIESEL (ALL)	0215-1023	-	-	-
TH 6X4 GATOR UTILITY VEHICLE GAS (ALL)	0215-1023	-	-	-
TS 4X2 GATOR UTILITY VEHICLE (ALL)	0215-1023	-	-	-
TX OR TX 4X2 GATOR UTILITY VEHICLE (ALL)	0215-1025	-	-	-
TX TURF OR TX 4X2 TURF GATOR UTILITY VEHICLE (ALL)	0215-1025	-	-	-
BUCK 500 UTILITY (ALL)	0215-0244	-	-	-
TRAIL BUCK 500 UTILITY (ALL)	0215-0244	-	-	-
XUV 550 GATOR UTILITY VEHICLE (ALL)	0215-1025	-	0215-1025	-
XUV 550 S4 GATOR UTILITY VEHICLE (ALL)	0215-1025	-	0215-1025	-
XUV GATOR UTILITY VEHICLE 6101 GAS (ALL)	0215-1025	-	0215-1026	-
XUV GATOR UTILITY VEHICLE 6521 GAS (ALL)	0215-1026	-	0215-1026	-
TRAIL BUCK 650 (ALL)	0215-0244	-	-	-
TRAIL BUCK 650EX (ALL)	0215-0244	-	-	-
TRAIL BUCK 650EXT (ALL)	0215-0244	-	-	-
XUV GATOR UTILITY VEHICLE 8251 GAS (ALL)	0215-1026	-	0215-1026	-
RSX 8501 GATOR UTILITY VEHICLE (ALL)	0215-1025	-	0215-1025	-
RSX 8501 SPORT GATOR UTILITY VEHICLE (ALL)	0215-1025	-	0215-1025	-
RSX 8501 TRAIL GATOR UTILITY VEHICLE (ALL)	0215-1025	-	0215-1025	-
XUV GATOR UTILITY VEHICLE 850D DIESEL 080000-DOWN (ALL)	0215-1025	-	0215-1026	-
XUV GATOR UTILITY VEHICLE 850D DIESEL 080001-UP (ALL)	0215-1025	-	0215-1026	-
XUV GATOR UTILITY VEHICLE 855D DIESEL (ALL)	0215-1026	-	0215-1026	-
XUV GATOR UTILITY VEHICLE 855D S4 (ALL)	0215-1026	-	0215-1026	-
KAWASAKI				
KLF110 87-88	A25-1215	2	-	-
KLF185 BAYOU 85-88	A25-1215	2	-	-
KLT200A 81-83	-	-	0215-0245	1
KLF220 BAYOU 88-02	A25-1088	2	A25-1275	1
KLF250 BAYOU 03-11	A25-1088	2	A25-1275	1
KEF300 LAKOTA 95-03	A25-1023	2	A25-1132	1
KLF300A BAYOU 86-87	A25-1070	2	A25-1274	1
KLF300B BAYOU 88-04	A25-1023	2	A25-1274	1
KLF300C BAYOU 4X4 89-04	0215-0159	2	A25-1275	1
KVF300A PRAIRIE 4X4 99-02	0215-0159	2	A25-1146	1
KVF300B PRAIRIE 2X4 99-00	0215-0159	2	A25-1146	1
KVF300B PRAIRIE 2X4 01-02	0215-0157	2	A25-1146	1
KVF300 BRUTE FORCE 12-16	A25-1035	2	0215-1007	1
MULE 500 91-95	A25-1403	-	A25-1274	1
MULE 520 00-01	A25-1403	-	A25-1274	1
MULE 550 97-04	A25-1403	-	A25-1274	1
KVF360A, C PRAIRIE 4X4 03-13	0215-0157	2	-	-
KVF360B PRAIRIE 03-12	0215-0157	2	-	-
KLF400 BAYOU 93-99	0215-0159	2	A25-1275	1
KVF400A, B PRAIRIE 97-98	0215-0159	2	A25-1146	1
KVF400C, D PRAIRIE 99-00	0215-0159	2	A25-1146	1
KVF400D, E PRAIRIE 01-02	0215-0157	2	A25-1146	1
MULE 600 05-16	0215-0202	2	-	-
MULE 610 4X4 05-16	0215-0202	2	0215-0956	-
MULE 1000 88	A25-1403	2	A25-1405	1
MULE 2010 90	A25-1404	2	A25-1405	1
MULE 2020 90	A25-1404	2	A25-1405	1
MULE 2030 91	A25-1404	2	A25-1405	1
MULE 2500 94-00	A25-1404	2	A25-1405	1
MULE 2510 4X4 93-00	A25-1404	2	A25-1405	1
MULE 2520 93-00	A25-1404	2	A25-1405	1
MULE 3000 01-08	A25-1404	2	0215-0202	2

PLOWES
WINCHES
UTV
RACKS
IMPLEMENTS & TOWING
LUGGAGE
BODY
CONTROLS
ELECTRICAL
WHEELS & TIRES
SUSPENSION & DRIVE
BRAKING
ENGINE
RIDER
GARAGE
PROMO

SUSPENSION & DRIVE

FITS MODEL	FRONT KIT		REAR KIT	
	PART #	QTY	PART #	QTY
WHEEL BEARING KITS (CON'T)				
KAWASAKI (CON'T)				
MULE 3010 4X4 01-08	A25-1404	2	0215-0202	2
MULE 3020 01-03	A25-1404	2	0215-0202	2
MULE 4000 09-14	A25-1404	2	0215-0202	2
MULE 4010 4X4 09-16	A25-1404	2	0215-0202	2
KVF650 BRUTE FORCE 05-12	0215-0157	2	-	-
KVF650 I BRUTE FORCE 06-17	0215-0157	2	0215-0202	2
KVF650 PRAIRIE 02-03	0215-0157	2	-	-
KFX 700 V-FORCE 04-09	A25-1035	2	-	-
KVF700 PRAIRIE 04-06	0215-0157	2	-	-
KVF750 BRUTE FORCE 05-17	0215-0157	2	0215-0202	2
TERYX 750 4 4X4 12-13	0215-0153 ¹	2	0215-1006	-
TERYX 750 4X4 08-14	0215-0153 ¹	2	0215-0202	2
TERYX 800 4 4X4 14-16	0215-0153 ¹	2	0215-1006	2
TERYX 800 4X4 14-16	0215-0153 ¹	2	0215-1006	2
MULE 2510 DIESEL 00	A25-1404	2	A25-1405	1
MULE 2510 DIESEL 01-02	A25-1404	2	0215-0202	2
MULE 3010 DIESEL 03-06	A25-1404	2	0215-0202	2
MULE 4010 4X4 DIESEL 10-13	A25-1404	2	0215-0202	2
MULE PRO-FX 800 15-16	0215-1032	2	0215-1031	2
MULE PRO-FXT 800 15-16	0215-1032	2	0215-1031	2
MULE PRO-FX 800 15-16	0215-1032	2	0215-1031	2
MULE PRO-FXT 800 15-16	0215-1032	2	0215-1031	2
KYMCO				
MAXXER 50	0215-0151	2	0215-0077	1
MONGOOSE 50 03-05	0215-0151	2	0215-0077	1
MONGOOSE 50 08	0215-0151	2	0215-0077	1
MONGOOSE 50 4 STROKE 06	0215-0151	2	0215-0077	1
MONGOOSE 06-08	0215-0151	2	0215-0077	1
MONGOOSE 90 04-05	0215-0151	2	0215-0077	1
KVR250	A25-1035	2	0215-0245	1
MAXXER 250	A25-1035	2	0215-0245	1
MONGOOSE 250 04-08	A25-1035	2	0215-0245	1
MXU250 04-05	A25-1035	2	0215-0245	1
MAXXER 300	A25-1035	2	0215-0245	1
MONGOOSE 300 05-08	A25-1035	2	0215-0245	1
MXU 300 05-08	A25-1035	2	-	-
MXU 400	0215-0153 ¹	2	0215-0153	1
MXU 500 2WD	0215-0153 ¹	2	-	-
MXU 500 4WD	0215-0153 ¹	2	-	-
SUZUKI				
LT-50 84-87	A25-1045	2	0215-0117	1
LT-A50 02-05	A25-1194	2	0215-0119	1
LT-Z50 06-09	A25-1194	2	0215-0119	1
LT-80 87-06	A25-1194	2	A25-1158	1
ALT-125 83-86	A25-1215	1	A25-1122	1
LT-125 83-87	A25-1215	2	A25-1122	1
LT-160 03-04	A25-1215	2	A25-1122	1
LT-160E 89-92	A25-1215	2	A25-1122	1
LT-F160 91-01	A25-1215	2	A25-1122	1
ALT-185F 85	A25-1215	1	A25-1122	1
LT-185 84-87	A25-1215	2	A25-1122	1
LT-230E 87-93	A25-1042	2	A25-1331	1
LT-230GE 85-86	A25-1043	2	A25-1149	1
LT-230S 85-88	A25-1042	2	A25-1331	1
LT-F230 86-87	A25-1043	2	A25-1149	1
LT-250EF 85-86	A25-1043	2	A25-1145	1
LT-250S 89-90	A25-1042	2	A25-1331	1
LT-4WD 250 87	A25-1108	2	-	-
LT-4WD 250 88-98	A25-1108	2	A25-1299	2
LT-F250 88-01	A25-1108	2	A25-1299	2
LT-F250 OZARK 02-13	A25-1215	2	0215-0154	1
LT-F250F (EXCEPT OZARK) 99-02	A25-1108	2	A25-1299	2
LT-F4WD 250 97-98	A25-1108	2	A25-1299	2
LT-300E 87-89	A25-1043	2	A25-1331	1
LT-F300F KING QUAD 99-02	A25-1108	2	A25-1299	2
LT-F4WDX KING QUAD 300 91-98	A25-1108	2	A25-1299	2
LT-A, LT-F400 2WD KING QUAD 08-09	A25-1108	2	A25-1293	2
LT-A, LT-F400 EIGER 2WD 02-04	A25-1108	2	A25-1293	2
LT-A, LT-F400 EIGER 2WD 07	A25-1108	2	A25-1293	2
LT-A, LT-F400F 4WD KING QUAD 08-15	A25-1108	2	A25-1293	2
LT-A, LT-F400F EIGER 4WD 02-07	A25-1108	2	A25-1293	2
LTA-450 X KING QUAD 07-10	0215-0247	2	0215-0246	2
LT-A500F QUAD MASTER AUTO 00-01	A25-1108	2	A25-1293	2
LT-A500F VINSON 02-07	A25-1108	2	A25-1293	2
LT-A500X 09-15	0215-0247	2	0215-0246	2
LT-F500F QUAD MASTER 00-01	A25-1108	2	A25-1293	2

FITS MODEL	FRONT KIT		REAR KIT	
	PART #	QTY	PART #	QTY
WHEEL BEARING KITS (CON'T)				
SUZUKI (CON'T)				
LT-F500F QUAD RUNNER 98-99	A25-1108	2	A25-1293	2
LT-F500F VINSON 02-07	A25-1108	2	A25-1293	2
LTA-700 X KING QUAD 05-07	0215-0247	2	0215-0246	2
LTV-700F TWIN PEAKS 04-06	0215-0157	2	-	-
LTA-750 X KING QUAD 08-15	0215-0247	2	0215-0246	2
YAMAHA				
YT60 84-85	A25-1009	1	A25-1404	1
YFM80 85-86	A25-1104	2	0215-0119	1
YFM80 87-88	A25-1052	2	0215-0119	1
YFM80 BADGER 92-01	A25-1052	2	-	-
YFM80 GRIZZLY 05-08	A25-1052	2	-	-
YFM100 87-88	A25-1052	2	0215-0119	1
YFM100 89-91	A25-1052	2	-	-
YFA1 91-04	A25-1052	2	A25-1314	1
YFM125 GRIZZLY 04-12	A25-1052	2	A25-1314	1
YFM125 GRIZZLY 13	A25-1052	2	-	-
YTI-125 83-85	-	-	A25-1314	1
YTI-175 82-83	A25-1104	1	A25-1314	1
YFM200 MOTO-4 85-89	A25-1064	2	A25-1011	1
YTM200 EK, EL, ERN 83-85	-	-	A25-1011	1
YTM200L, N 84-85	A25-1104	1	-	-
YFM225 MOTO-4 86-88	A25-1064	2	A25-1011	1
YTM225 TRI-MOTO, DXK, DXL 83-86	A25-1104	1	A25-1011	1
YFB250 TIMBERWOLF 92-94	A25-1048	2	A25-1134	1
YFB250F TIMBERWOLF 95-98	A25-1044	2	A25-1134	1
YFB250FW TIMBERWOLF 94-00	A25-1108	2	A25-1134	1
YFM250 BEARTRACKER 99	A25-1226	2	0215-0120	1
YFM250 BEARTRACKER 00	A25-1226	2	A25-1139	1
YFM250 BEARTRACKER 01-04	A25-1044	2	A25-1139	1
YFM250 BIG BEAR 07-09	A25-1044	2	A25-1139	1
YFM250 MOTO-4 89-91	A25-1044	2	A25-1010	1
YFM250B BRUIN 05-06	A25-1044	2	A25-1139	1
YT2250 TRI MOTO 85-86	-	-	A25-1315	1
YFM300 GRIZZLY 12-13	-	-	A25-1124	1
YFM350 GRIZZLY IRS 07-13	A25-1108	2	0215-0153 ¹	2
YFM350A, BA BRUIN 2WD 04-06	A25-1108	2	A25-1139	1
YFM350ER MOTO-4 87-89	A25-1064	2	A25-1010	1
YFM350ER MOTO-4 90-95	A25-1044	2	A25-1010	1
YFM350FA BRUIN 4WD 04-06	A25-1108	2	A25-1139	1
YFM350FGW GRIZZLY 4WD 07-14	A25-1108	2	A25-1139	1
YFM350FW BIG BEAR 87-95	A25-1108	2	A25-1010	1
YFM350FW BIG BEAR 96-99	A25-1108	2	0215-0120	1
YFM350GW GRIZZLY 2WD 07-11	A25-1108	2	A25-1139	1
YFM350U BIG BEAR 96-99	A25-1108	2	0215-0120	1
YFM350FX WOLVERINE 95-99	A25-1108	2	A25-1017	1
YFM350FX WOLVERINE 00-05	A25-1108	2	A25-1018	1
YFM350X WOLVERINE 06-09	A25-1108	2	A25-1139	1
YFM400 BIG BEAR 2WD 00-04	A25-1108	2	A25-1139	1
YFM400 BIG BEAR 4WD 00-06	A25-1108	2	A25-1139	1
YFM400 BIG BEAR IRS 07-12	A25-1108	2	0215-0153 ¹	2
YFM400 GRIZZLY IRS 07-08	A25-1108	2	0215-0153 ¹	2
YFM400 KODIAK 2WD 00-01	A25-1108	2	A25-1012	1
YFM400 KODIAK 2WD 03-04	A25-1108	2	A25-1139	1
YFM400 KODIAK 4WD 93-99	A25-1108	2	A25-1015	1
YFM400 KODIAK 4WD 00-02	A25-1108	2	A25-1012	1
YFM400 KODIAK 4WD 03-04	A25-1108	2	A25-1139	1
YFM400 KODIAK 4WD 05-06	A25-1108	2	0215-0153 ¹	2
YFM450 GRIZZLY IRS 07-14	A25-1108	2	0215-0153 ¹	2
YFM450 KODIAK 03-04	A25-1108	2	A25-1012	1
YFM450 KODIAK 05-06	A25-1108	2	0215-0153 ¹	2
YFM45FX WOLVERINE 450 4X4 06-10	A25-1108	2	0215-0248	1
YFM550 GRIZZLY/EPS 09-14	0215-0153 ¹	2	0215-0153 ¹	2
YFM600 GRIZZLY 98	A25-1108	2	0215-0120	1
YFM600 GRIZZLY 99-01	A25-1108	2	A25-1139	1
YFM660 GRIZZLY 02	0215-0015	2	0215-0016	1
YFM660 GRIZZLY 03-08	0215-0153 ¹	2	0215-0153 ¹	2
YFM700 GRIZZLY EPS 08-17	0215-0153 ¹	2	0215-0153 ¹	2
YFM700 KODIAK 16-17	0215-0153 ¹	2	0215-0153 ¹	2
RHINO 450 06-09	A25-1108	2	0215-0221	2
RHINO 660 04-07	A25-1108	2	0215-0221	2
RHINO 700 FI 08-13	A25-1108	2	0215-0221	2
VIKING 700 14-17	0215-0988	2	0215-0988	2
WOLVERINE R-SPEC 16-17	0215-0988	2	0215-0988	-
YXZ1000R 16	0215-0221	2	0215-1033	2
YXZ1000R EPS 17	0215-0153 ¹	2	0215-1033	2
YXZ1000R EPS SS 17	0215-0153 ¹	2	0215-1033	2

¹ NO SEALS INCLUDED

FITS MODEL	FRONT KIT PART #	QTY	FRONT STRUT KIT PART #	REAR KIT PART #	QTY
POLARIS WHEEL BEARING KITS					
POLARIS					
SPORTSMAN 90 01-03	0215-0151	2	-	0215-0077	1
SPORTSMAN 90 04-14	0215-0151	2	-	0215-0224	1
OUTLAW 110 2016	0215-0151	2	-	0215-0224	1
PHOENIX 200 06-13	0215-0160	2	-	-	-
CYCLONE 250 87	-	-	-	A25-1321	1
TRAIL BLAZER 250 90-98	A25-1129	2	-	A25-1321	1
TRAIL BLAZER 250 99-04	A25-1129	2	-	A25-1151	1
TRAIL BLAZER 250 05-06	0215-0160	2	-	A25-1151	1
TRAIL BOSS 250 85-87	-	-	-	A25-1321	1
TRAIL BOSS 250 88-99	A25-1129	2	-	A25-1321	1
TRAIL BOSS 250 4X4 87-88	A25-1008	2	-	A25-1321	1
TRAIL BOSS 250 4X4 89-90	A25-1008	2	-	A25-1321	1
TRAIL BOSS 250 4X4 91-93	A25-1008	2	A25-1007	A25-1321	1
XPLORER 250 4X4 00-02	A25-1008	2	A25-1006	A25-1151	1
BIG BOSS 250 4X6 89-92	A25-1129	2	-	A25-1321	1
BIG BOSS 250 6X6 91-93	A25-1008	2	A25-1007	A25-1321	1
300 2X4 94-95	A25-1129	2	-	A25-1321	1
300 4X4 94	A25-1008	2	A25-1006	A25-1321	1
HAWKEYE 06-11	0215-0078	2	-	0215-0078	2
SPORTSMAN 300 4X4 08-11	0215-0078	2	-	0215-0078	2
TRAIL BOSS 300 4X4 95	A25-1008	2	A25-1006	A25-1321	1
XPLORER 300 4X4 96-98	A25-1008	2	A25-1006	A25-1321	1
XPLORER 300 4X4 99	A25-1008	2	A25-1006	-	-
XPRESS 300 96-99	A25-1129	2	-	A25-1321	1
BIG BOSS 300 6X6 94	A25-1008	2	A25-1007	A25-1321	1
MAGNUM 325 2X4 00-01	A25-1129	2	-	A25-1322	1
MAGNUM 325 2X4 02	A25-1129	2	-	0215-0078	1
MAGNUM 325 4X4 00-01	A25-1008	2	A25-1006	A25-1322	1
MAGNUM 325 4X4 02	A25-1008	2	A25-1006	0215-0078	1
MAGNUM 325 4X4 HDS 01-02	0215-0078	2	-	0215-0078	1
TRAIL BOSS 325 00-02	A25-1129	2	-	A25-1151	1
XPEDITION 325 00-01	0215-1008	2	A25-1006	A25-1322	1
XPEDITION 325 02	A25-1008	2	A25-1006	0215-0078	1
ATP 330 4X4 04-05	0215-0078	2	-	0215-0078	1
MAGNUM 330 2X4 03-05	A25-1129	2	-	0215-0078	1
MAGNUM 330 4X4 03-05	0215-0078	2	-	0215-0078	1
TRAIL BLAZER 330 08-09	0215-0160	2	-	A25-1151	1
TRAIL BLAZER 330 10-13	0215-0078	2	-	A25-1151	1
TRAIL BOSS 330 03-04	A25-1129	2	-	A25-1151	1
TRAIL BOSS 330 05-09	0215-0160	2	-	A25-1151	1
TRAIL BOSS 330 10-13	0215-0078	2	-	A25-1151	1
SPORTSMAN 335 99-00	A25-1008	2	A25-1006	A25-1150	1
WORKER 335 99	A25-1008	2	A25-1006	A25-1150	1
350L 2X4 93	A25-1129	2	-	A25-1321	1
350L 4X4 93	A25-1008	2	A25-1007	A25-1321	1
SPORTSMAN 350 4X4 93	A25-1008	2	A25-1007	A25-1321	1
TRAIL BOSS 350L 2X4 90-92	A25-1129	2	-	A25-1321	1
TRAIL BOSS 350L 4X4 90-92	A25-1008	2	A25-1007	A25-1321	1
BIG BOSS 350L 6X6 93	A25-1008	2	A25-1007	A25-1321	1
SCRAMBLER 380 2X4 00	A25-1129	2	-	A25-1151	1
400L 2X4 94-95	A25-1129	2	-	A25-1321	1
400L 4X4 94	A25-1129	2	A25-1007	A25-1321	1
SCRAMBLER 400 2X4 01-02	A25-1129	2	-	A25-1151	1
SCRAMBLER 400 4X4 95-97	A25-1008	2	A25-1006	A25-1321	1
SCRAMBLER 400 4X4 98-02	A25-1008	2	A25-1006	A25-1151	1
SPORT 400 94-98	A25-1129	2	-	A25-1321	1
SPORT 400 99	A25-1129	2	-	A25-1151	1
SPORTSMAN 400 4X4 94	A25-1008	2	A25-1007	A25-1321	1
SPORTSMAN 400 4X4 95-97	A25-1008	2	A25-1006	A25-1321	1
SPORTSMAN 400 4X4 01-03	A25-1008	2	A25-1006	A25-1150	1
SPORTSMAN 400 4X4 AA AE AG 04	0215-0078	2	A25-1006	A25-1150	1
SPORTSMAN 400 4X4 AQ AV 04	0215-0078	2	-	A25-1150	1
SPORTSMAN 400 4X4 05	0215-0078	2	-	A25-1150	1
SPORTSMAN 400 HO 4X4 08-10	0215-0078	2	-	0215-0078	2
SPORTSMAN 400 HO 4X4 11-14	0215-0078	2	-	A25-1150	1
TRAIL BLAZER 400 03	A25-1129	2	-	A25-1151	1
XPLORER 400L 4X4 95-98	A25-1008	2	A25-1006	A25-1321	1
BIG BOSS 400L 6X6 96-97	A25-1008	2	A25-1006	A25-1321	1
MAGNUM 400L 6X6 96-97	A25-1008	2	A25-1006	A25-1321	1
HAWKEYE 400 2X4 12-14	0215-0078	2	-	A25-1150	1
MAGNUM 425 2X4 95-98	A25-1129	2	-	A25-1321	1
MAGNUM 425 4X4 96	A25-1008	2	A25-1006	-	-
MAGNUM 425 4X4 98	A25-1008	2	A25-1006	A25-1321	1
XPEDITION 425 00-01	A25-1008	2	A25-1006	A25-1322	1
XPEDITION 425 02	A25-1008	2	A25-1006	0215-0078	1

FITS MODEL	FRONT KIT PART #	QTY	FRONT STRUT KIT PART #	REAR KIT PART #	QTY
POLARIS WHEEL BEARING KITS (CON'T)					
POLARIS (CON'T)					
XPLORER 400L 4X4 99-02	A25-1008	2	A25-1006	A25-1151	1
XPRESS 400L 2X4 96-97	A25-1129	2	-	A25-1321	1
BIG BOSS 400L 6X6 94	A25-1008	2	A25-1007	A25-1321	1
BIG BOSS 400L 6X6 95	A25-1008	2	-	A25-1321	1
SPORTSMAN 450 06-07	0215-0078	2	-	A25-1150	1
DIESEL 455 4X4 99-01	A25-1008	2	A25-1006	A25-1150	1
ATP 500 4X4 04-05	0215-0078	2	-	0215-0078	1
MAGNUM 500 2X4 HDS 02	A25-1129	2	-	0215-0078	1
MAGNUM 500 4X4 99-01	A25-1008	2	A25-1006	A25-1322	1
MAGNUM 500 4X4 02	0215-0078	2	-	0215-0078	1
MAGNUM 500 4X4 HDS 01-03	0215-0078	2	-	0215-0078	1
SPORTSMAN 500 4X4 96-00	A25-1008	2	A25-1006	A25-1150	1
SPORTSMAN 500 4X4 HO 01-03	A25-1008	2	A25-1006	A25-1150	1
SPORTSMAN 500 4X4 HO AA- AC- AE- AG 04	A25-1008	2	A25-1006	A25-1150	1
SPORTSMAN 500 4X4 HO AD - AW 04	0215-0078	2	-	A25-1150	1
SPORTSMAN 500 4X4 HO 05-13	0215-0078	2	-	A25-1150	1
SPORTSMAN 500 4X4 RSE 99-02	A25-1008	2	A25-1006	A25-1150	1
SPORTSMAN 500 EFI 09-10	0215-0078	2	-	A25-1150	1
SPORTSMAN 500 HO 08-13	0215-0078	2	-	A25-1150	1
SPORTSMAN 500 X2 06-09	0215-0078	2	-	A25-1150	1
SPORTSMAN TOURING 500 EFI 08-13	0215-0078	2	-	A25-1150	1
XPLORER 500 97	A25-1008	2	A25-1006	A25-1150	1
BIG BOSS 500 6X6 98-99	A25-1008	2	A25-1006	A25-1321	1
BIG BOSS 500 6X6 00-03	A25-1008	2	A25-1006	A25-1151	1
SPORTSMAN 500 6X6 00-08	A25-1008	2	A25-1006	A25-1151	1
SPORTSMAN 550 EPS 10-14	0215-0738	2	-	0215-0738	2
SPORTSMAN 550 11-12	0215-0738	2	-	0215-0738	2
SPORTSMAN 550 X2 10-12	0215-0738	2	-	0215-0738	2
SPORTSMAN TOURING EPS 550 11-14	0215-0738	2	-	0215-0738	2
XP 550 BUILT AFTER 12/1/08 09	0215-0738	2	-	0215-0738	2
SPORTSMAN 600 4X4 03-05	0215-0078	2	-	A25-1150	1
SPORTSMAN 700 4X4 02-04	0215-0078	2	-	A25-1150	1
SPORTSMAN 700 TWIN 05-07	0215-0078	2	-	A25-1150	1
SPORTSMAN X2 700 TWIN EFI 08	0215-0078	2	-	A25-1150	1
SPORTSMAN 800 EFI 05-13	0215-0078	2	-	A25-1150	1
SPORTSMAN TOURING 800 EFI 08-09	0215-0078	2	-	A25-1150	1
SPORTSMAN X2 800 EFI 07-09	0215-0078	2	-	A25-1150	1
SPORTSMAN 800 EFI 6X6 09-13	0215-0078	2	-	A25-1150	1
SPORTSMAN TOURING EPS 850 10-12	0215-0738	2	-	0215-0738	1
SPORTSMAN X2 850 11-12	0215-0738	2	-	0215-0738	1
SPORTSMAN XP 850 09-13	0215-0738	2	-	0215-0738	1
SPORTSMAN XP 850 EPS 10-14	0215-0738	2	-	0215-0738	1
RANGER 4X4 400 10-14	0215-0078	2	-	A25-1150	1
RANGER 2X4 500 08-09	0215-0078	2	-	A25-1150	1
RANGER 4X4 500 04-08	0215-0078	2	-	A25-1150	1
RANGER 4X4 500 09-10	0215-0738	2	-	A25-1150	1
RANGER 4X4 500 99	A25-1008	2	A25-1006	-	-
RANGER 4X4 500, RANGER 4X4 500 CREW 11-13	0215-0078	2	-	A25-1150	1
RANGER 4X4 700 05-08	0215-0078	2	-	A25-1150	1
RANGER 4X4 700 09	0215-0738	2	-	A25-1150	1
RANGER 4X4 700 CREW 08-09	0215-0078	2	-	A25-1150	1
RANGER 4X4 800 EFI, EFI CREW 10-12	0215-0738	2	-	A25-1150	1
RANGER 4X4 900 D 11	0215-0738	2	-	A25-1150	1
RANGER 4X4 CREW DIESEL 900 D 11-12	0215-0738	2	-	A25-1150	1
RANGER 6X6 500 02	A25-1008	2	-	-	-
RANGER 6X6 500 04	0215-0078	2	-	A25-1150	1
RANGER 6X6 700 EFI 06-09	0215-0078	2	-	A25-1150	1
RANGER 6X6 800 10-14	0215-0738	2	-	A25-1150	1
RANGER 900 13-14	0215-0738	2	-	A25-1150	1
RANGER 900 CREW 14-16	0215-0738	2	-	A25-1150	1
RANGER 900 XP 13-16	0215-0738	2	-	A25-1150	1
RANGER SERIES 10 4X4/6X6 07	0215-0078	2	-	A25-1150	1
RANGER SERIES 11 4X4/6X6 07	0215-0078	2	-	A25-1150	1
RZR 170 09-14	0215-0957	2	-	0215-0958	1
RZR 4/EPS RGE 11	0215-0738	2	-	A25-1150	1
RZR 570 12-14	0215-0738	2	-	-	-
RZR S 800 09	0215-0418	2	-	A25-1150	1
RZR 800 11-13	0215-0738	2	-	A25-1150	1
RZR 4 900 15-16	0215-0738	2	-	0215-0738	1
RZR 900 50 55 INCH 15-16	0215-0738	2	-	0215-0738	2
RZR 900 60 INCH 15-16	0215-0738	2	-	0215-0738	2
RZR XP 900 11-14	0215-0738	2	-	0215-0738	2
RANGER 1000 DIESEL 15-16	0215-0738	2	-	A25-1150	1
RANGER 1000 DIESEL CREW 15-16	0215-0738	2	-	A25-1150	1
RZR 1000 60 INCH 16	0215-0738	2	-	0215-0738	2

PLOWS
WINCHES
UTV
RACKS
IMPLEMENT & TOWING
LUGGAGE
BODY
CONTROLS
ELECTRICAL
WHEELS & TIRES
SUSPENSION & DRIVE
BRAKING
ENGINE
RIDER
GARAGE
PROMO

SUSPENSION & DRIVE

FITS MODEL	FRONT KIT PART #	FRONT STRUT KIT PART #	REAR KIT PART #	QTY	QTY
POLARIS WHEEL BEARING KITS (CON'T)					
POLARIS (CON'T)					
RZR S 800 10-13	0215-0738	2	A25-1150	1	1
RZR 800 08-09	0215-0418	2	A25-1150	1	1
RZR 800 BUILT 12/31/09 AND BEFORE 10	0215-0418	2	A25-1150	1	1
RZR 800 BUILT 1/01/10 AND AFTER 10	0215-0738	2	A25-1150	1	1
RZR XP 1000 14-16	0215-0738	2	0215-0738	2	2
RZR XP 1000 TURBO 16	0215-0738	2	0215-0738	2	2
RZR XP 4 1000 14-16	0215-0738	2	0215-0738	2	2
BRUTUS HD PTO 13-15	0215-0738	2	A25-1150	2	2

DIFFERENTIAL BEARINGS AND SEAL KITS

Kits include high-speed bearings that are premium-quality and use EMQ standard seals. Garter-spring inner lips and optimal sealing from rubber-covered outside diameter seals.



FITS MODEL	BEARING & SEAL KIT FRONT #	BEARING & SEAL KIT REAR #	SEAL ONLY KIT FRONT #	SEAL ONLY KIT REAR #
DIFFERENTIAL BEARINGS AND SEAL KITS				
ARCTIC CAT				
250 4X4 01-02	A25-2022	-	0935-0416	-
250 4X4 03	-	-	0935-1034	-
250 4X4 04-05	-	-	0935-0471	-
300 4X4 98-01	A25-2022	-	0935-0416	-
300 4X4 02-03	-	-	0935-1034	-
300 4X4 04	1205-0181	-	0935-0471	-
300 4X4 05	-	-	0935-0471	-
366 FIS W/AT 08-11	1205-0181	1205-0181	0935-0471	0935-0471
375 4X4 W/AT 02	-	-	0935-1034	-
400 4X4 98-00	A25-2022	-	0935-0416	-
400 4X4 W/AT 03	-	-	0935-1034	-
400 4X4 W/AT 04	-	-	0935-0471	-
400 4X4 W/MT 01	A25-2022	-	0935-0416	-
400 4X4 W/MT 02-03	-	-	0935-1034	-
400 4X4 W/MT 04	-	-	0935-0471	-
400 FIS 2X4 W/AT 04	-	1205-0181	-	0935-0471
400 FIS 2X4 W/MT 03	-	-	-	0935-1034
400 FIS 2X4 W/MT 04	-	1205-0181	-	0935-0471
400 FIS 4X4 TRV 06-14	1205-0182	1205-0181	0935-0472	0935-0471
400 FIS 4X4 W/AT 03	-	-	0935-1034	-
400 FIS 4X4 W/AT 04	-	1205-0181	0935-0471	0935-0471
400 FIS 4X4 W/AT 05-08	1205-0182	1205-0181	0935-0472	0935-0471
400 FIS 4X4 W/MT 02-03	-	-	0935-1034	0935-1034
400 FIS 4X4 W/MT 04	-	1205-0181	0935-0471	0935-0471
400 FIS 4X4 W/MT 05-08	1205-0182	1205-0181	0935-0472	0935-0471
400 TBX 4X4 04	-	1205-0181	0935-0471	0935-0471
400 TBX 4X4 05-06	1205-0181	1205-0181	0935-0471	0935-0471
400 VP 4X4 W/AT & MT 05-06	1205-0181	-	0935-0471	-
450 HI 10-11	1205-0182	1205-0181	0935-0472	0935-0471
450 TRV 12	1205-0182	1205-0181	0935-0472	0935-0471
450I EFI 12	1205-0182	1205-0181	0935-0472	0935-0471
450I TRV GT EFI 12	1205-0182	1205-0181	0935-0472	0935-0471
454 4X4 96-98	A25-2022	-	0935-0416	-
500 4X4 98-99	A25-2022	-	0935-0416	-
500 4X4 W/AT 00-01	A25-2022	-	0935-0416	-
500 4X4 W/AT 02	-	-	0935-1034	-
500 4X4 W/MT 00-01	A25-2022	-	0935-0416	-
500 EFI 4X4 W/AT 13-14	-	1205-0181	-	0935-0471

FITS MODEL	BEARING & SEAL KIT FRONT #	BEARING & SEAL KIT REAR #	SEAL ONLY KIT FRONT #	SEAL ONLY KIT REAR #
DIFFERENTIAL BEARINGS AND SEAL KITS (CON'T)				
ARCTIC CAT (CON'T)				
500 FIS 4X4 W/AT 02-03	-	-	0935-1034	0935-1034
500 FIS 4X4 W/AT 04	-	1205-0181	0935-0471	0935-0471
500 FIS 4X4 W/AT 05-09	1205-0182	1205-0181	0935-0472	0935-0471
500 FIS 4X4 W/MT 02-03	-	-	0935-1034	0935-1034
500 FIS 4X4 W/MT 04	-	1205-0181	0935-0471	0935-0471
500 FIS 4X4 W/MT 05-09	1205-0182	1205-0181	0935-0472	0935-0471
500 FIS TBX 4X4 02-03	-	-	0935-1034	-
500 FIS TBX 4X4 04	-	1205-0181	0935-0471	0935-0471
500 FIS TBX 4X4 05-06	1205-0182	1205-0181	0935-0472	0935-0471
500 FIS TRV 4X4 03	-	-	0935-1034	0935-1034
500 FIS TRV 4X4 04	-	1205-0181	0935-0471	0935-0471
500 FIS TRV 4X4 05-08	1205-0182	1205-0181	0935-0472	0935-0471
500 TRV 13-14	1205-0182	1205-0181	0935-0472	0935-0471
500 XT EFI 13-14	1205-0182	1205-0181	0935-0472	0935-0471
550 EFI 4X4 12-13	1205-0182	1205-0181	0935-0472	0935-0471
550 GT EFI 4X4 12	1205-0182	1205-0181	0935-0472	0935-0471
550 HI FIS 4X4 09-11	1205-0182	1205-0181	0935-0472	0935-0471
550 TRV 4X4 W/AT 09-13	1205-0182	1205-0181	0935-0472	0935-0471
550 XT EFI 4X4 13	1205-0182	1205-0181	0935-0472	0935-0471
550 XT LTD EFI 12-14	1205-0182	1205-0181	0935-0472	0935-0471
PROWLER 550 09-13	1205-0182	1205-0181	0935-0471	0935-0471
650 4X4 HI 05-11	1205-0182	1205-0181	0935-0472	0935-0471
650 4X4 HI MUD PRO 10-11	1205-0182	1205-0181	0935-0472	0935-0471
650 4X4 W/AT V2 04-06	1205-0182	1205-0181	0935-0472	0935-0471
650 HI TBX 07-09	1205-0182	1205-0181	0935-0472	0935-0471
650 TRV 09	1205-0182	1205-0181	0935-0472	0935-0471
650I 4X4 12	1205-0182	1205-0181	0935-0472	0935-0471
PROWLER 650 07	-	1205-0181	0935-0471	0935-0471
PROWLER 650 XT 06-09	1205-0182	1205-0181	0935-0471	0935-0471
700 AT EFI 06	1205-0182	1205-0181	0935-0472	0935-0471
700 DIESEL 07-14	1205-0182	1205-0181	0935-0472	0935-0471
700 EFI 07-08	1205-0182	1205-0181	0935-0472	0935-0471
700 EFI / LTD 11-14	1205-0182	1205-0181	0935-0472	0935-0471
700 EFI HI 08-11	1205-0182	1205-0181	0935-0472	0935-0471
700 EFI HI MUDPRO 09-11	1205-0182	1205-0181	0935-0472	0935-0471
700 GT EFI 12	1205-0182	1205-0181	0935-0472	0935-0471
700 LTD EFI 13	1205-0182	1205-0181	0935-0472	0935-0471
700 TBX 10-14	1205-0182	1205-0181	0935-0472	0935-0471
700 TRV 08-14	1205-0182	1205-0181	0935-0472	0935-0471
700 XT 13-14	1205-0182	-	0935-0472	-
700I EFI MUDPRO / LTD 12-13	1205-0182	1205-0181	0935-0472	0935-0471
700I EFI MUDPRO / LTD 14	1205-0182	-	0935-0472	-
700I HI TRV GT EFI 11-12	1205-0182	1205-0181	0935-0472	0935-0471
PROWLER 700 HDX 12-14	1205-0182	1205-0181	0935-0471	0935-0471
PROWLER 700 XT 09	1205-0182	-	-	-
PROWLER 700 XTX 08-14	1205-0182	1205-0181	0935-0471	0935-0471
1000 TRV 13	1205-0182	-	0935-0472	-
1000 TRV / CRUISER 09-12	1205-0182	-	0935-0472	-
1000 TRV GT 12	1205-0182	-	0935-0472	-
1000 XT 13-14	1205-0182	-	0935-0472	-
1000I GT 12	1205-0182	-	0935-0472	-
1000I LTD EFI MUDPRO 12-14	1205-0182	-	0935-0472	-
H2 MUDPRO 10-11	1205-0182	-	0935-0472	-
H2 THUNDERCAT 08-11	1205-0182	-	0935-0472	-
PROWLER 1000 XTZ 11-14	1205-0182	-	0935-0471	-
PROWLER 1000 XTZ H2 09-11	1205-0182	-	0935-0471	-
WILDCAT 1000 14	-	1205-0259	-	-
WILDCAT 4 13-14	-	1205-0259	-	-
WILDCAT 4 LTD 14	-	1205-0259	-	-
WILDCAT 4X 14-15	-	1205-0259	-	-
WILDCAT GT 12-13	-	1205-0259	-	-
WILDCAT LTD 13-14	-	1205-0259	-	-
WILDCAT X 13	-	1205-0259	-	-
WILDCAT X / LTD 14-15	-	1205-0259	-	-
CAN-AM				
OUTLANDER 330 04-05	1205-0192	1205-0192	0935-0479	0935-0479
OUTLANDER 400 03-04	1205-0192	1205-0192	0935-0479	0935-0479
OUTLANDER 400 STD 4X4 05	1205-0192	1205-0192	0935-0479	0935-0479
OUTLANDER 400 STD 4X4 06-10	1205-0192	1205-0191	0935-0479	0935-0478
OUTLANDER 400 STD 4X4 11-15	1205-0192	1205-0237	0935-0479	0935-0611
OUTLANDER 400 XT 4X4 04-05	1205-0192	1205-0192	0935-0479	0935-0479
OUTLANDER 400 XT 4X4 06-08	1205-0192	1205-0191	0935-0479	0935-0478
OUTLANDER 400 XT 4X4 12-14	1205-0192	1205-0237	0935-0479	0935-0611
OUTLANDER MAX 400 EFI/STD/XT 15	1205-0192	1205-0237	0935-0479	0935-0611

FITS MODEL	BEARING & SEAL KIT FRONT #	BEARING & SEAL KIT REAR #	SEAL ONLY KIT FRONT #	SEAL ONLY KIT REAR #
DIFFERENTIAL BEARINGS AND SEAL KITS (CONT)				
CAN-AM (CONT)				
OUTLANDER MAX 400 STD 4X4 05	1205-0192	1205-0192	0935-0479	0935-0479
OUTLANDER MAX 400 STD 4X4 06-10	1205-0192	1205-0191	0935-0479	0935-0478
OUTLANDER MAX 400 STD 4X4 11-14	1205-0192	1205-0237	0935-0479	0935-0611
OUTLANDER MAX 400 XT 4X4 06-08	1205-0192	1205-0191	0935-0479	0935-0478
OUTLANDER MAX 400 XT 4X4 13-14	1205-0192	1205-0237	0935-0479	0935-0611
OUTLANDER DPS 450 EFI 16-18	1205-0192	1205-0266	0935-0479	0935-0971
OUTLANDER DPS 450 EFI 19	1205-0192	-	0935-0479	0935-0971
OUTLANDER L 450 EFI 15-16	1205-0192	1205-0266	0935-0479	0935-0971
OUTLANDER L MAX 450 EFI 15-16	1205-0192	1205-0266	0935-0479	0935-0971
OUTLANDER MAX 450 6X6 19	1205-0192	-	0935-0479	-
OUTLANDER MAX 450 EFI 17	1205-0192	1205-0266	0935-0479	0935-0971
OUTLANDER MAX DPS 450 EFI 16-18	1205-0192	1205-0266	0935-0479	0935-0971
OUTLANDER MAX DPS 450 EFI 19	1205-0192	-	0935-0479	0935-0971
OUTLANDER MAX STD 450 EFI 18	1205-0192	1205-0266	0935-0479	0935-0971
OUTLANDER MAX STD 450 EFI 19	1205-0192	-	0935-0479	0935-0971
OUTLANDER STD 450 EFI 17-18	1205-0192	1205-0266	0935-0479	0935-0971
OUTLANDER STD 450 EFI 19	1205-0192	-	0935-0479	0935-0971
DEFENDER 500 17-18	1205-0266	1205-0266	0935-0971	0935-0971
DEFENDER 500 19	-	1205-0266	-	0935-0971
DEFENDER 500 DPS 17-18	1205-0266	1205-0266	0935-0971	0935-0971
DEFENDER 500 DPS 19	-	1205-0266	-	0935-0971
OUTLANDER 500 LTD 4X4 10	1205-0192	1205-0191	0935-0479	0935-0478
OUTLANDER 500 STD 4X4 07-10	1205-0192	1205-0191	0935-0479	0935-0478
OUTLANDER 500 STD 4X4 11-14	1205-0192	1205-0237	0935-0479	0935-0611
OUTLANDER 500 STD 4X4 15	1205-0192	1205-0266	0935-0479	0935-0971
OUTLANDER 500 XT 4X4 07-10	1205-0192	1205-0191	0935-0479	0935-0478
OUTLANDER 500 XT 4X4 11-14	1205-0192	1205-0237	0935-0479	0935-0611
OUTLANDER L 500 EFI 15	1205-0192	1205-0266	0935-0479	0935-0971
OUTLANDER L MAX 500 EFI 15	1205-0192	1205-0266	0935-0479	0935-0971
OUTLANDER MAX 500 EFI 15	1205-0192	1205-0266	0935-0479	0935-0971
OUTLANDER MAX 500 STD 4X4 07-10	1205-0192	1205-0191	0935-0479	0935-0478
OUTLANDER MAX 500 STD 4X4 11-14	1205-0192	1205-0237	0935-0479	0935-0611
OUTLANDER MAX 500 XT 4X4 07-10	1205-0192	1205-0191	0935-0479	0935-0478
OUTLANDER MAX 500 XT 4X4 11-14	1205-0192	1205-0237	0935-0479	0935-0611
QUEST 500 02-04	-	-	0935-0479	-
RENEGADE 500 08-10	1205-0192	1205-0191	0935-0479	0935-0478
RENEGADE 500 11-14	1205-0192	1205-0237	0935-0479	0935-0611
RENEGADE 500 15	1205-0192	1205-0266	0935-0479	0935-0971
RENEGADE 500 XT 12	1205-0192	1205-0237	0935-0479	0935-0611
TRAXTER 500 99-04	-	-	0935-0479	-
TRAXTER 500 05	1205-0192	-	0935-0479	-
TRAXTER 500 AUTO CVT 05	1205-0192	-	0935-0479	-
OUTLANDER DPS 570 EFI 16-18	1205-0192	1205-0266	0935-0479	0935-0971
OUTLANDER DPS 570 EFI 19	1205-0192	-	0935-0479	0935-0971
OUTLANDER L 570 EFI 16	1205-0192	1205-0266	0935-0479	0935-0971
OUTLANDER LE 570 EFI 16	1205-0192	1205-0266	0935-0479	0935-0971
OUTLANDER MAX 570 EFI 16-17	1205-0192	1205-0266	0935-0479	0935-0971
OUTLANDER MAX DPS 570 EFI 16-18	1205-0192	1205-0266	0935-0479	0935-0971
OUTLANDER MAX DPS 570 EFI 19	1205-0192	-	0935-0479	0935-0971
OUTLANDER MAX STD 570 EFI 18	1205-0192	1205-0266	0935-0479	0935-0971
OUTLANDER MAX STD 570 EFI 19	1205-0192	-	0935-0479	0935-0971
OUTLANDER STD 570 EFI 17-18	1205-0192	1205-0266	0935-0479	0935-0971
OUTLANDER STD 570 EFI 19	1205-0192	-	0935-0479	0935-0971
OUTLANDER XMR 570 EFI 16-18	1205-0192	1205-0266	0935-0479	0935-0971
OUTLANDER XMR 570 EFI 19	1205-0192	-	0935-0479	0935-0971
RENEGADE 570 EFI 16-18	1205-0192	1205-0266	0935-0479	0935-0971
RENEGADE 570 EFI 19	1205-0192	-	0935-0479	-
RENEGADE XMR 570 EFI 17	1205-0192	1205-0266	0935-0479	0935-0971
RENEGADE XMR 570 EFI 18-19	1205-0192	-	0935-0479	-
OUTLANDER 650 6X6 15-18	1205-0192	-	0935-0479	-
OUTLANDER 650 STD 4X4 06-10	1205-0192	1205-0191	0935-0479	0935-0478
OUTLANDER 650 STD 4X4 11-14	1205-0192	1205-0237	0935-0479	0935-0611
OUTLANDER 650 STD 4X4 15	1205-0192	1205-0266	0935-0479	0935-0971
OUTLANDER 650 XMR 13-14	1205-0192	1205-0237	0935-0479	0935-0611
OUTLANDER 650 XMR 15	1205-0192	1205-0266	0935-0479	0935-0971
OUTLANDER 650 XT 4X4 06-10	1205-0192	1205-0191	0935-0479	0935-0478
OUTLANDER 650 XT 4X4 11-14	1205-0192	1205-0237	0935-0479	0935-0611
OUTLANDER DPS 650 EFI 17-18	1205-0192	1205-0266	0935-0479	0935-0971
OUTLANDER DPS 650 EFI 19	1205-0192	-	0935-0479	0935-0971
OUTLANDER MAX 650 6X6 19	1205-0192	-	0935-0479	-
OUTLANDER MAX 650 STD 4X4 06-09	1205-0192	1205-0191	0935-0479	0935-0478
OUTLANDER MAX 650 STD 4X4 11-14	1205-0192	1205-0237	0935-0479	0935-0611
OUTLANDER MAX 650 STD 4X4 15	1205-0192	1205-0266	0935-0479	0935-0971
OUTLANDER MAX 650 XT 4X4 06-09	1205-0192	1205-0191	0935-0479	0935-0478

FITS MODEL	BEARING & SEAL KIT FRONT #	BEARING & SEAL KIT REAR #	SEAL ONLY KIT FRONT #	SEAL ONLY KIT REAR #
DIFFERENTIAL BEARINGS AND SEAL KITS (CONT)				
CAN-AM (CONT)				
OUTLANDER MAX 650 XT 4X4 11-14	1205-0192	1205-0237	0935-0479	0935-0611
OUTLANDER STD 650 EFI 17-18	1205-0192	1205-0266	0935-0479	0935-0971
OUTLANDER STD 650 EFI 19	1205-0192	-	0935-0479	0935-0971
QUEST 650 STD / XT 02-04	1205-0192	-	0935-0479	-
RENEGADE 650 EFI 18-19	1205-0192	-	0935-0479	-
TRAXTER 650 04-05	1205-0192	-	0935-0479	-
COMMANDER 800 DPS 13	1205-0192	1205-0237	0935-0479	0935-0611
COMMANDER 800 DPS 14-19	1205-0192	1205-0267	0935-0479	0935-1003
COMMANDER 800 LTD 16	1205-0192	1205-0267	0935-0479	0935-1003
COMMANDER 800 STD 11-15	1205-0192	1205-0237	0935-0479	0935-0611
COMMANDER 800 STD 16-19	1205-0192	1205-0267	0935-0479	0935-1003
COMMANDER 800 XT 11-13	1205-0192	1205-0237	0935-0479	0935-0611
COMMANDER 800 XT 14-19	1205-0192	1205-0267	0935-0479	0935-1003
COMMANDER 800 XTP 16	1205-0192	1205-0267	0935-0479	0935-1003
COMMANDER MAX 800 DPS 16-19	1205-0192	1205-0267	0935-0479	0935-1003
OUTLANDER 800 STD 4X4 06-08	1205-0192	1205-0191	0935-0479	0935-0478
OUTLANDER 800 XMR 11-12	1205-0192	1205-0237	0935-0479	0935-0611
OUTLANDER 800 XT 4X4 06-08	1205-0192	1205-0191	0935-0479	0935-0478
OUTLANDER 800 XMC 11	1205-0192	1205-0191	0935-0479	0935-0478
OUTLANDER 800R STD 4X4 09-10	1205-0192	1205-0191	0935-0479	0935-0478
OUTLANDER 800R STD 4X4 11-14	1205-0192	1205-0237	0935-0479	0935-0611
OUTLANDER 800R STD 4X4 15	1205-0192	1205-0266	0935-0479	0935-0971
OUTLANDER 800R XMR 15	1205-0192	-	0935-0479	-
OUTLANDER 800R XT 4X4 09-10	1205-0192	1205-0191	0935-0479	0935-0478
OUTLANDER 800R XT 4X4 11-14	1205-0192	1205-0237	0935-0479	0935-0611
OUTLANDER MAX 800 LTD/STD 4X4 07-08	1205-0192	1205-0191	0935-0479	0935-0478
OUTLANDER MAX 800 XT 4X4 06-08	1205-0192	1205-0191	0935-0479	0935-0478
OUTLANDER MAX 800R EFI 15	1205-0192	1205-0266	0935-0479	0935-0971
OUTLANDER MAX 800R LTD 4X4 09-10	1205-0192	1205-0191	0935-0479	0935-0478
OUTLANDER MAX 800R LTD 4X4 11-12	1205-0192	1205-0237	0935-0479	0935-0611
OUTLANDER MAX 800R STD 4X4 09-10	1205-0192	1205-0191	0935-0479	0935-0478
OUTLANDER MAX 800R STD 4X4 11-14	1205-0192	1205-0237	0935-0479	0935-0611
OUTLANDER MAX 800R XT 4X4 09-10	1205-0192	1205-0191	0935-0479	0935-0478
OUTLANDER MAX 800R XT 4X4 11-14	1205-0192	1205-0237	0935-0479	0935-0611
OUTLANDER 850 DPS 16-18	1205-0192	1205-0266	0935-0479	0935-0971
OUTLANDER 850 DPS 19	1205-0192	-	0935-0479	-
OUTLANDER 850 XMR 16	1205-0192	-	0935-0479	-
OUTLANDER 850 XT 16	1205-0192	1205-0266	0935-0479	0935-0971
OUTLANDER 850 XTP 16	1205-0192	1205-0266	0935-0479	0935-0971
OUTLANDER MAX 850 DPS 17-18	1205-0192	1205-0266	0935-0479	0935-0971
OUTLANDER MAX 850 DPS 19	1205-0192	-	0935-0479	-
OUTLANDER MAX 850 XT 16	1205-0192	1205-0266	0935-0479	0935-0971
COMMANDER 1000 DPS 16-19	1205-0192	1205-0267	0935-0479	0935-1003
COMMANDER 1000 LTD 13	1205-0192	1205-0237	0935-0479	0935-0611
COMMANDER 1000 LTD 14-19	1205-0192	1205-0267	0935-0479	0935-1003
COMMANDER 1000 STD 11-13	1205-0192	1205-0237	0935-0479	0935-0611
COMMANDER 1000 STD 14-19	1205-0192	1205-0267	0935-0479	0935-1003
COMMANDER 1000 XT 16-19	1205-0192	1205-0267	0935-0479	0935-1003
COMMANDER 1000 XT/DPS 13	1205-0192	1205-0237	0935-0479	0935-0611
COMMANDER 1000 XT/DPS 14-15	1205-0192	1205-0267	0935-0479	0935-1003
COMMANDER 1000 XT/LTD/DPS 11-12	1205-0192	1205-0237	0935-0479	0935-0611
COMMANDER 1000 XT 14-17	1205-0192	1205-0267	0935-0479	0935-1003
COMMANDER MAX 1000 DPS 18-19	1205-0192	1205-0267	0935-0479	0935-1003
COMMANDER MAX 1000 LTD/STD 15-19	1205-0192	1205-0267	0935-0479	0935-1003
COMMANDER MAX 1000 XT 18-19	1205-0192	1205-0267	0935-0479	0935-1003
COMMANDER MAX 1000 XT/DPS 15-17	1205-0192	1205-0267	0935-0479	0935-1003
COMMANDER MAX 1000 XT/DPS/LTD 14	1205-0192	1205-0267	0935-0479	0935-1003
COMMANDER MAX 1000 XTP 15	1205-0192	1205-0267	0935-0479	0935-1003
MAVERICK 1000 STD/ALL 13-18	1205-0192	-	0935-0479	-
MAVERICK MAX 1000 STD/ALL 14-18	1205-0192	-	0935-0479	-
OUTLANDER 1000 DPS 12-14	1205-0192	1205-0237	0935-0479	0935-0611
OUTLANDER 1000 DPS 15-18	1205-0192	1205-0266	0935-0479	0935-0971
OUTLANDER 1000 DPS 19	1205-0192	-	0935-0479	-
OUTLANDER 1000 EFI 6X6 15-18	1205-0192	-	0935-0479	-
OUTLANDER 1000 XMR 13-19	1205-0192	-	0935-0479	-
OUTLANDER 1000 XT 12-14	1205-0192	1205-0237	0935-0479	0935-0611
OUTLANDER 1000 XT 15-18	1205-0192	1205-0266	0935-0479	0935-0971
OUTLANDER 1000 XT 19	1205-0192	-	0935-0479	-
OUTLANDER 1000 XTP 13-14	1205-0192	1205-0237	0935-0479	0935-0611
OUTLANDER 1000 XTP 15-18	1205-0192	1205-0266	0935-0479	0935-0971
OUTLANDER 1000 XTP 19	1205-0192	-	0935-0479	-
OUTLANDER MAX 1000 13-14	1205-0192	1205-0237	0935-0479	0935-0611
OUTLANDER MAX 1000 15-18	1205-0192	1205-0266	0935-0479	0935-0971
OUTLANDER MAX 1000 19	1205-0192	-	0935-0479	-

PLOWES
WINCHES
UTV
RACKS
IMPLEMENT & TOWING
LUGGAGE
BODY
CONTROLS
ELECTRICAL
WHEELS & TIRES
SUSPENSION & DRIVE
BRAKING
ENGINE
RIDER
GARAGE
PROMO

SUSPENSION & DRIVE

FITS MODEL	BEARING & SEAL KIT FRONT #	BEARING & SEAL KIT REAR #	SEAL ONLY KIT FRONT #	SEAL ONLY KIT REAR #
DIFFERENTIAL BEARINGS AND SEAL KITS (CON'T)				
CAN-AM (CON'T)				
OUTLANDER MAX 1000 EFI 6X6 19	1205-0192	-	0935-0479	-
OUTLANDER MAX 1000 LTD 15-16	1205-0192	1205-0266	0935-0479	0935-0971
OUTLANDER MAX 1000 XT 13-14	1205-0192	1205-0237	0935-0479	0935-0611
OUTLANDER MAX 1000 XT 15-18	1205-0192	1205-0266	0935-0479	0935-0971
OUTLANDER MAX 1000 XT 19	1205-0192	-	0935-0479	-
OUTLANDER MAX 1000 XTP 13-14	1205-0192	1205-0237	0935-0479	0935-0611
OUTLANDER MAX 1000 XTP 15-18	1205-0192	1205-0266	0935-0479	0935-0971
OUTLANDER MAX 1000 XTP 19	1205-0192	-	0935-0479	-
CF-MOTO				
U FORCE 500 HO 15-17	1205-0265	1205-0123	-	-
U FORCE 500 HO 18	1205-0265	-	-	-
U FORCE RANCHER 500 11-13	1205-0265	1205-0123	-	-
Z FORCE 500 18	1205-0265	-	-	-
Z FORCE 500 HO 16	1205-0265	1205-0123	-	-
Z FORCE 500 HO 17	1205-0265	-	-	-
Z FORCE 500 Z5 18	1205-0265	-	-	-
U FORCE RANCHER 600 11-14	1205-0265	1205-0123	-	-
Z FORCE 600 & Z6 11	1205-0265	1205-0123	-	-
Z FORCE Z6 13	1205-0265	1205-0123	-	-
Z6 SPORT 12&14	1205-0265	1205-0123	-	-
Z FORCE Z6 SPORT 15	1205-0265	1205-0123	-	-
Z6-EX SPORT 12-14	1205-0265	1205-0123	-	-
U FORCE 800 16	1205-0265	-	-	-
U FORCE 800 EX 15	1205-0265	-	-	-
U FORCE 800 EX 17	1205-0265	1205-0123	-	-
U FORCE 800 EX 18	1205-0265	-	-	-
U FORCE TRACKER 800 13-14	1205-0265	1205-0123	-	-
Z FORCE 800 17	1205-0265	1205-0123	-	-
Z FORCE 800 18	1205-0265	-	-	-
Z FORCE 800 EX 17	1205-0265	1205-0123	-	-
Z FORCE 800 EX 18	1205-0265	-	-	-
Z FORCE 800 TRAIL 18	1205-0265	-	-	-
Z FORCE 800 Z8 EX 18	1205-0265	-	-	-
Z FORCE 800 Z8 TRAIL 18	1205-0265	-	-	-
Z FORCE Z8 & EX 16	1205-0265	1205-0123	-	-
Z FORCE Z8 EX SPORT 15	1205-0265	1205-0123	-	-
Z8-EX SPORT 14	1205-0265	1205-0123	-	-
Z FORCE 1000 18	1205-0265	-	-	-
Z FORCE 1000 EX 18	1205-0265	-	-	-
HONDA				
ATC200ES 84	-	A25-2007	-	-
TRX200 84	-	A25-2007	-	-
ATC250ES 85-87	-	A25-2008	-	0935-0409
ATC250SX 85-87	-	A25-2008	-	0935-0409
TRX250 FOURTRAX 85-87	-	A25-2008	-	0935-0409
TRX250 RECON 97-01	-	A25-2009	-	0935-0410
TRX250TE RECON 02-19	-	A25-2009	-	0935-0410
TRX250TM RECON 02-19	-	A25-2009	-	0935-0410
TRX300 FOURTRAX 88-00	-	A25-2010	-	0935-0411
TRX300FW FOURTRAX 4X4 88-00	A25-2001	A25-2010	0935-0406	0935-0411
TRX350 86	-	-	-	0935-0409
TRX350 87	-	-	-	0935-0409
TRX350D 87-89	-	-	-	0935-0409
TRX350FE 00-06	A25-2003	A25-2012	0935-0407	0935-0412
TRX350FM FOURTRAX RANCHER 00-06	A25-2003	A25-2012	0935-0407	0935-0412
TRX350TE 00-06	-	A25-2012	-	0935-0412
TRX350TM FOURTRAX RANCHER 00-06	-	A25-2012	-	0935-0412
TRX400FA 04-07	-	A25-2012	0935-0474	0935-0412
TRX400FGA FOURTRAX RANCHER 4X4 04-07	-	A25-2012	0935-0474	0935-0412
TRX400FW FOURTRAX FOREMAN 4X4 95-01	A25-2004	A25-2013	0935-0408	0935-0413
TRX400FW FOURTRAX FOREMAN 4X4 02-03	-	A25-2014	0935-0467	0935-0414
TRX420 FA IRS 09-14	1205-0200	1205-0188	0935-0481	-
TRX420 FA IRS 15-19	1205-0254	1205-0286	0935-0969	0935-1004
TRX420 FA SOLID AXLE 14-19	1205-0254	1205-0216	0935-0969	0935-0480
TRX420 FE 07-13	1205-0200	1205-0199	0935-0481	0935-0480
TRX420 FE 14-19	1205-0254	1205-0216	0935-0969	0935-0480
TRX420 FM 07-13	1205-0200	1205-0199	0935-0481	0935-0480
TRX420 FM 14-19	1205-0254	1205-0216	0935-0969	0935-0480
TRX420 FPA IRS 09-14	1205-0200	1205-0188	0935-0481	-
TRX420 FPA SOLID AXLE 14	1205-0254	1205-0216	0935-0969	0935-0480
TRX420 FPE 09-13	1205-0200	1205-0199	0935-0481	0935-0480
TRX420 TE 07-13	-	1205-0199	-	0935-0480
TRX420 TE 14-16	-	1205-0216	-	0935-0480
TRX420 TM 07-13	-	1205-0199	-	0935-0480

FITS MODEL	BEARING & SEAL KIT FRONT #	BEARING & SEAL KIT REAR #	SEAL ONLY KIT FRONT #	SEAL ONLY KIT REAR #
DIFFERENTIAL BEARINGS AND SEAL KITS (CON'T)				
HONDA (CON'T)				
TRX420 TM 14-16	-	1205-0216	-	0935-0480
TRX420 TM 17-19	-	1205-0216	-	0935-0967
TRX450ES 98-01	A25-2004	A25-2013	0935-0408	0935-0413
TRX450FE/FM 02-04	-	A25-2014	0935-0467	0935-0414
TRX450S 98-01	A25-2004	A25-2013	0935-0408	0935-0413
TRX500FA 01-04	-	A25-2014	0935-0467	0935-0414
TRX500FA 05-14	1205-0127	1205-0128	0935-0474	0935-0475
TRX500FA 15-19	1205-0285	1205-0286	0935-1008	0935-1004
TRX500FE 05-11	1205-0127	1205-0128	0935-0474	0935-0475
TRX500FE 12-13	-	1205-0216	0935-0969	0935-0967
TRX500FE 14-19	1205-0285	1205-0216	0935-1008	0935-0967
TRX500FGA 04	-	A25-2014	0935-0474	0935-0414
TRX500FGA 05-11	1205-0127	1205-0128	0935-0474	0935-0475
TRX500FM 12-13	-	1205-0216	0935-0969	0935-0967
TRX500FM IRS 15-19	1205-0285	1205-0286	0935-1008	0935-1004
TRX500FM SOLID AXLE 14-19	1205-0285	1205-0216	0935-1008	0935-0967
TRX500FPA 09-14	1205-0127	1205-0128	0935-0474	0935-0475
TRX500FPE 07-11	1205-0127	1205-0128	0935-0474	0935-0475
TRX500FPE 12-13	-	1205-0216	0935-0969	0935-0967
TRX500FPM 08-11	1205-0127	1205-0128	0935-0474	0935-0475
TRX500FPM 12-13	-	1205-0216	0935-0969	0935-0967
TRX500TM 05-06	-	1205-0128	-	0935-0475
TRX650 RINCON 03-05	1205-0127	1205-0125	0935-0474	0935-0420
TRX680 RINCON 06-19	1205-0127	1205-0125	0935-0474	0935-0420
JOHN DEERE				
TRAIL BUCK 650 ALL	1205-0192	-	-	-
KAWASAKI				
KLF220 BAYOU 88-02	-	A25-2018	-	-
KLF250 BAYOU 03-11	-	A25-2018	-	-
KLF300B BAYOU 88-05	-	A25-2038	-	-
KLF300C BAYOU 4X4 89-05	A25-2015	A25-2020	-	-
KVF300 BRUTE FORCE 12-18	-	1205-0260	-	-
KVF300A PRAIRIE 4X4 99-02	A25-2016	A25-2021	-	0935-0415
KVF300B PRAIRIE 2X4 99-02	-	A25-2021	-	0935-0415
KVF360A PRAIRIE 4X4 03-13	1205-0187	1205-0152	0935-0422	0935-0476
KLF400 BAYOU 93-99	A25-2015	A25-2020	-	-
KVF400A PRAIRIE 4X4 97-98	A25-2016	A25-2021	-	0935-0415
KVF400B PRAIRIE 98	-	A25-2021	-	0935-0415
KVF400C PRAIRIE 4X4 99-02	A25-2016	A25-2021	-	0935-0415
KVF400D PRAIRIE 99-02	-	A25-2021	-	0935-0415
MULE 610 4X4 05-16	A25-2016	-	-	-
MULE SX 19	A25-2016	-	-	-
MULE 2510 4X4 93-00	1205-0243	-	-	-
MULE 3010 4X4 01-08	1205-0243	-	-	-
MULE 4010 4X4 09-19	1205-0243	-	-	-
KVF650 BRUTE FORCE 05-13	1205-0187	1205-0152	0935-0422	0935-0476
KVF650 I BRUTE FORCE 06-13	1205-0187	-	0935-0422	0935-0612
KVF650 PRAIRIE 02-03	1205-0187	1205-0152	0935-0422	0935-0476
KFX 700 V-FORCE 04-09	-	1205-0152	-	0935-0476
KVF700 PRAIRIE 04-06	1205-0187	1205-0152	0935-0422	0935-0476
KVF750 BRUTE FORCE 05-14	1205-0187	-	0935-0422	0935-0612
KVF750 BRUTE FORCE 15	-	-	0935-0422	0935-0612
KVF750 BRUTE FORCE 16-19	-	-	-	0935-0612
KVF750 BRUTE FORCE EPS 12-14	1205-0187	-	0935-0422	0935-0612
KVF750 BRUTE FORCE EPS 15-19	-	-	-	0935-0612
TERYX 750 4X4 08-13	1205-0244	-	-	-
MULE 2510 DIESEL 00-02	1205-0243	-	-	-
MULE 3010 DIESEL 01-08	1205-0243	-	-	-
MULE 4010 4X4 DIESEL 09-13	1205-0243	-	-	-
KYMCO				
MAXXER 450I ALL	1205-0182	1205-0181	0935-0472	0935-0471
MXU 450I ALL	1205-0182	1205-0181	0935-0472	0935-0471
POLARIS				
LSV ELECTRIC 4X4 11-12	1205-0167	-	0935-0421	-
RANGER EV 4X4 10-19	1205-0167	-	0935-0421	-
RANGER EV LIION 16-18	1205-0167	-	0935-0421	-
RANGER EV MIDSIZE INTL 14	1205-0167	-	0935-0421	-
HAWKEYE 4X4 06-07	1205-0168	-	0935-1035	-
SPORTSMAN 300 4X4 08-10	1205-0168	-	0935-1035	-
ACE 325 14-16	1205-0212	-	0935-0966	-
MAGNUM 325 2X4/4X4 00-02	-	1205-0164	-	0935-0473
RANGER 325 ETX 15	-	-	0935-1036	-
RANGER 325 ETX 16	1205-0212	-	0935-0966	-
SPORTSMAN 325 ETX EFI 15	1205-0269	-	0935-0970	-

FITS MODEL	BEARING & SEAL KIT FRONT #	BEARING & SEAL KIT REAR #	SEAL ONLY KIT FRONT #	SEAL ONLY KIT REAR #
DIFFERENTIAL BEARINGS AND SEAL KITS (CON'T)				
POLARIS (CON'T)				
XPEdition 325 00-02	-	1205-0164	-	0935-0473
ATP 330 4X4 04-05	1205-0167	-	0935-0421	-
MAGNUM 330 4X4 FB 03-05	1205-0167	1205-0165	0935-0421	-
RANGER 4X4 400 10-14	1205-0168	-	0935-1035	-
SPORTSMAN 400 4X4 05	1205-0167	-	0935-0421	-
SPORTSMAN 400 4X4 AQ-AV 04	1205-0167	-	0935-0421	-
SPORTSMAN 400 HD 4X4 09-12	1205-0168	-	0935-1035	-
SPORTSMAN 400 HD 4X4 13-14	1205-0269	-	0935-0970	-
XPEdition 425 00-02	-	1205-0164	-	0935-0473
SPORTSMAN 450 06	1205-0167	-	0935-0421	-
SPORTSMAN 450 07	1205-0168	-	0935-1035	-
SPORTSMAN 450 HD 16-19	1205-0269	-	0935-0970	-
ACE 500 17-19	1205-0212	-	0935-0966	-
ATP 500 4X4 04-05	1205-0167	-	0935-0421	-
ATV 500 PRO 02	-	1205-0164	-	0935-0473
MAGNUM 500 4X4 00-01	-	1205-0164	-	0935-0473
MAGNUM 500 4X4 AA 02	1205-0167	1205-0164	0935-0421	0935-0473
MAGNUM 500 4X4 99	-	1205-0164	-	0935-0473
MAGNUM 500 4X4 HDS 03	-	1205-0165	-	-
MAGNUM 500 4X4 HDS AA 01-02	-	1205-0164	-	0935-0473
MAGNUM 500 4X4 HDS FB 01	-	1205-0164	-	0935-0473
RANGER 2X4 500 05-06	-	1205-0326	-	-
RANGER 2X4 500 08-09	-	1205-0234	-	-
RANGER 4X4 500 04	1205-0167	-	0935-0421	-
RANGER 4X4 500 05-06	1205-0167	1205-0326	0935-0421	-
RANGER 4X4 500 CREW 11-13	1205-0168	-	0935-1035	-
RANGER 4X4 500 EFI 06	1205-0167	1205-0326	0935-0421	-
RANGER 4X4 500 EFI 08	1205-0167	1205-0234	0935-0421	-
RANGER 4X4 500 EFI 09	1205-0168	1205-0234	0935-1035	-
RANGER 4X4 500 EFI 10-13	1205-0168	-	0935-1035	-
RANGER 500 4X4 19	1205-0212	-	0935-0966	-
RANGER 500 ETX 17	1205-0212	-	0935-0966	-
RANGER 6X6 500 02-04	1205-0167	-	0935-0421	-
RANGER 6X6 500 05	1205-0167	1205-0326	0935-0421	-
RANGER SERIES 10 4X4 & 6X6 07	1205-0167	-	0935-0421	-
RANGER SERIES 11 4X4 & 6X6 07	1205-0167	-	0935-0421	-
SPORTSMAN 500 4X4 HO 04-06	1205-0167	-	0935-0421	-
SPORTSMAN 500 4X4 HO 07-12	1205-0168	-	0935-1035	-
SPORTSMAN 500 X2 06-09	1205-0168	-	0935-1035	-
SPORTSMAN 500 4X4 HO 13	1205-0269	-	0935-0970	-
SPORTSMAN TOURING 500 08-13	1205-0168	-	0935-1035	-
SPORTSMAN 550 11-13	-	1205-0233	0935-1036	0935-0968
SPORTSMAN 550 EPS 10-14	-	1205-0233	0935-1036	0935-0968
SPORTSMAN 550 X2 10-14	-	1205-0233	0935-1036	0935-0968
SPORTSMAN 550 X2 EPS LE 14	-	1205-0233	0935-1036	0935-0968
SPORTSMAN 550 X2 INTL 14	-	1205-0233	0935-1036	0935-0968
SPORTSMAN 550 XP 10-14	-	1205-0233	0935-1036	0935-0968
SPORTSMAN TOURING 550 EPS 10-14	-	1205-0233	0935-1036	0935-0968
ACE 570 15-19	1205-0212	-	0935-0966	-
ACE 570 EU 15-16	1205-0212	-	0935-0966	-
ACE 570 EU 17-18	1205-0212	-	0935-0966	-
ACE 570 HD 15-19	1205-0212	-	0935-0966	-
ACE 570 MD 16	1205-0212	-	0935-0966	-
RANGER 570 14-15	-	-	0935-1036	-
RANGER 570 16-19	1205-0212	-	0935-0966	-
RANGER 570 CREW 14-15	-	-	0935-1036	-
RANGER 570 CREW 16-19	1205-0212	-	0935-0966	-
RANGER 570 CREW EPS 14-15	-	-	0935-1036	-
RANGER 570 CREW EPS 16-19	1205-0212	-	0935-0966	-
RANGER 570 EPS 14-15	-	-	0935-1036	-
RANGER 570 EPS 16-18	1205-0212	-	0935-0966	-
RANGER 570 EPS 19	1205-0212	-	0935-0966	-
RANGER 570 EU 15	-	-	0935-1036	-
RANGER 570 EU 16	1205-0212	-	0935-1036	-
RANGER 570 FULL SIZE 15-19	1205-0212	-	0935-0966	-
RANGER 570 FULL SIZE CREW 15-16	1205-0212	-	0935-0966	-
RANGER 570 FULL SIZE WITH STRUT 16	1205-0212	-	0935-0966	-
RANGER 570 HD 19	1205-0212	-	0935-0966	-
RANGER 570 INTL 14	-	-	0935-1036	-
RANGER 570 XP 16	1205-0212	-	0935-0966	-
RANGER 570-6 FULL SIZE CREW 16-19	1205-0212	-	0935-0966	-
RZR 570 EFI 12-19	1205-0212	-	0935-0966	-
SPORTSMAN 570 6X6 14-19	1205-0269	-	0935-0970	-
SPORTSMAN 570 EFI X2 EPS 15-19	1205-0269	-	0935-0970	-

FITS MODEL	BEARING & SEAL KIT FRONT #	BEARING & SEAL KIT REAR #	SEAL ONLY KIT FRONT #	SEAL ONLY KIT REAR #
DIFFERENTIAL BEARINGS AND SEAL KITS (CON'T)				
POLARIS (CON'T)				
SPORTSMAN 570 EPS EU 17-18	1205-0269	-	0935-0970	-
SPORTSMAN 570 EPS QUAD 16	1205-0269	-	0935-0970	-
SPORTSMAN 570 EPS UTE QUAD 16	1205-0269	-	0935-0970	-
SPORTSMAN 570 EPS ZUG 16-18	1205-0269	-	0935-0970	-
SPORTSMAN 570 HD 15	1205-0269	-	0935-0970	-
SPORTSMAN 570 HD EFI 14	1205-0269	-	0935-0970	-
SPORTSMAN 570 SP 15-19	1205-0269	-	0935-0970	-
SPORTSMAN 570 SP EPS QUAD 15-16	1205-0269	-	0935-0970	-
SPORTSMAN 570 SP MD 15-16	1205-0269	-	0935-0970	-
SPORTSMAN 570 X2 EPS MD 17	1205-0269	-	0935-0970	-
SPORTSMAN TOURING 570 EFI 14-19	1205-0269	-	0935-0970	-
SPORTSMAN 600 4X4 03	1205-0167	1205-0164	0935-0421	0935-0473
SPORTSMAN 600 4X4 05	1205-0167	1205-0165	0935-0421	-
RANGER 4X4 700 05-06	1205-0167	1205-0326	0935-0421	-
RANGER 4X4 700 08	1205-0167	1205-0234	0935-0421	-
RANGER 4X4 700 09	1205-0168	1205-0234	0935-1035	-
RANGER 4X4 700 CREW 08-09	1205-0167	1205-0234	0935-0421	-
RANGER 6X6 700 EFI 06-09	1205-0167	-	0935-0421	-
SPORTSMAN 700 4X4 02-03	1205-0167	1205-0164	0935-0421	0935-0473
SPORTSMAN 700 4X4 05-06	1205-0167	1205-0165	0935-0421	-
SPORTSMAN 700 4X4 07	1205-0168	1205-0165	0935-1035	-
SPORTSMAN 700 EFI 05-06	1205-0167	1205-0165	0935-0421	-
SPORTSMAN 700 EFI 07	1205-0168	1205-0165	0935-1035	-
SPORTSMAN MV7 05	1205-0167	1205-0165	0935-0421	-
SPORTSMAN X2 700 EFI 08	1205-0168	-	0935-1035	-
RANGER 4X4 800 EFI 10-14	1205-0168	-	0935-1035	-
RANGER 4X4 800 EFI CREW 10-14	1205-0168	-	0935-1035	-
RANGER 4X4 800 EFI MIDSIZE 13-14	1205-0168	-	0935-1035	-
RANGER 6X6 800 10-14	1205-0168	1205-0234	0935-1035	-
RANGER 6X6 800 15-16	1205-0269	-	0935-0970	-
RANGER XP 800 12	1205-0168	-	0935-1035	-
RZR 4 800 10	1205-0214	1205-0239	-	-
RZR 4 800 11-14	1205-0212	1205-0239	0935-0966	-
RZR 800 08-09	1205-0214	1205-0239	-	-
RZR 800 11-14	1205-0212	1205-0239	0935-0966	-
RZR S 800 09	1205-0214	1205-0239	-	-
RZR S 800 11-14	1205-0212	1205-0239	0935-0966	-
SPORTSMAN 800 EFI 05	1205-0167	1205-0165	0935-0421	-
SPORTSMAN 800 EFI 07	1205-0168	1205-0165	0935-1035	-
SPORTSMAN 800 EFI 09-14	1205-0168	-	0935-1035	-
SPORTSMAN 800 EFI 6X6 09-14	1205-0168	-	0935-1035	-
SPORTSMAN 800 HO EFI 09	1205-0168	-	0935-1035	-
SPORTSMAN TOURING 800 EFI 08-09	1205-0168	-	0935-1035	-
SPORTSMAN X2 800 EFI 07-09	1205-0168	-	0935-1035	-
SPORTSMAN 850 SP 15-18	-	1205-0233	0935-1036	0935-0968
SPORTSMAN 850 WV 14	-	1205-0233	0935-1036	0935-0968
SPORTSMAN 850 XP HO EPS MD 15	-	1205-0233	0935-1036	0935-0968
SPORTSMAN TOURING 850 10-19	-	1205-0233	0935-1036	0935-0968
SPORTSMAN X2 850 11	-	1205-0233	0935-1036	0935-0968
SPORTSMAN XP 850 09	-	-	0935-1036	0935-0968
SPORTSMAN XP 850 EPS 10-14	-	1205-0233	0935-1036	0935-0968
ACE 900 EFI EPS 16	1205-0212	-	0935-0966	-
ACE 900 EPS XC 17-19	1205-0212	-	0935-0966	-
BRUTUS HD 900 13-15	1205-0212	-	0935-0966	-
RANGER 4X4 900 DIESEL 11-14	1205-0212	1205-0234	0935-0966	-
RANGER 900 CREW 14-19	1205-0212	-	0935-0966	-
RANGER 900 CREW EPS 14-17	1205-0212	-	0935-0966	-
RANGER 900 CREW EPS 19	1205-0212	-	0935-0966	-
RANGER 900 XP 13-19	1205-0212	-	0935-0966	-
RANGER 900 XP EPS 19	1205-0212	-	0935-0966	-
RANGER 900 XP EU 15-16	1205-0212	-	0935-0966	-
RANGER DIESEL HST/DELUXE 14	1205-0212	-	0935-0966	-
RANGER DIESEL INTL 14	1205-0212	-	0935-0966	-
RZR 4 900 15-16	1205-0212	-	0935-0966	-
RZR 4 900 17	1205-0270	-	-	-
RZR 4 XP 900 12-14	1205-0212	-	0935-0966	-
RZR 900 50 55 INCH 15-17	1205-0212	-	0935-0966	-
RZR 900 50 INCH 18-19	1205-0212	-	0935-0966	-
RZR 900 50 INCH MD 17	1205-0212	-	0935-0966	-
RZR 900 60 INCH 16-19	1205-0212	-	0935-0966	-
RZR XP 900 11-14	1205-0212	-	0935-0966	-
GENERAL 1000 EPS 16-17	1205-0212	-	0935-0966	-
RANGER 1000 DIESEL 15	1205-0212	-	0935-0966	-
RANGER 1000 DIESEL 16-17	1205-0212	-	0935-0966	-

PLOWS
WINCHES
UTV
RACKS
IMPLEMENTS & TOWING
LUGGAGE
BODY
CONTROLS
ELECTRICAL
WHEELS & TIRES
SUSPENSION & DRIVE
BRAKING
ENGINE
RIDER
GARAGE
PROMO

SUSPENSION & DRIVE

FITS MODEL	BEARING & SEAL KIT FRONT #	BEARING & SEAL KIT REAR #	SEAL ONLY KIT FRONT #	SEAL ONLY KIT REAR #
DIFFERENTIAL BEARINGS AND SEAL KITS (CON'T)				
POLARIS (CON'T)				
RANGER 1000 DIESEL 18	1205-0212	-	0935-0966	-
RANGER 1000 DIESEL CREW 15-18	1205-0212	-	0935-0966	-
RANGER 1000 DIESEL EU 15-16	1205-0212	-	0935-0966	-
RANGER 1000 EPS BASE 18-19	1205-0212	-	0935-0966	-
RANGER 1000 EPS HD MD 19	1205-0212	-	0935-0966	-
RANGER HST 15-16	1205-0212	-	0935-0966	-
RANGER XP 1000 EPS CREW 19	1205-0212	-	0935-0966	-
RZR 1000 60 INCH 16	1205-0212	-	0935-0966	-
RZR XP 1000 14-15	1205-0212	-	0935-0966	-
RZR XP 1000 17	1205-0270	-	-	-
RZR XP 1000 INTL 15	1205-0212	-	0935-0966	-
RZR XP 4 1000 14-15	1205-0212	-	0935-0966	-
RZR XP 4 1000 17	1205-0270	-	-	-
RZR XP 4 TURBO 16	1205-0270	-	-	-
RZR XP TURBO 16-17	1205-0270	-	-	-
RZR XP TURBO MD 16	1205-0270	-	-	-
SPORTSMAN 1000 HIGH LIFTER 16	-	1205-0233	0935-1036	0935-0968
SPORTSMAN 1000 HIGH LIFTER 17	1205-0214	1205-0233	-	0935-0968
SPORTSMAN 1000 HIGH LIFTER 18-19	-	1205-0233	0935-1036	0935-0968
SPORTSMAN 1000 MD 15	-	1205-0233	0935-1036	0935-0968
SPORTSMAN 1000 XP 15-18	-	1205-0233	0935-1036	0935-0968
SPORTSMAN TOURING 1000 15-19	-	1205-0233	0935-1036	0935-0968
SUZUKI				
LT-4WD 250 QUAD RUNNER 87-98	A25-2022	-	0935-0416	-
LT-F250 OZARK 02-14	-	1205-0126	-	0935-0818
LT-F250F 4WD QUAD RUNNER 99-02	A25-2022	-	0935-0416	-
LT-F300F KING QUAD 99-02	A25-2022	-	0935-0416	-
LT-F4WDX KING QUAD 300 91-98	A25-2022	-	0935-0416	-
LT-A500F QUAD MASTER AUTO 00	A25-2022	-	0935-0416	-
LT-A500F QUAD MASTER AUTO 01	A25-2022	-	0935-0416	-
LT-F500F 98-00	A25-2022	-	0935-0416	-
LT-F500F 01-02	A25-2022	-	0935-0416	-
LTV-700F TWIN PEAKS 04-06	1205-0187	1205-0152	0935-0422	0935-0476
YAMAHA				
YTM200 EK 83	-	A25-2030	-	0935-0417
YTM200 EL 84	-	A25-2030	-	0935-0417
YTM200 ERN 85	-	A25-2030	-	0935-0417
YTM200 K 83	-	A25-2030	-	0935-0417
YFM225 MOTO-4 86-88	-	A25-2030	-	0935-0417
YTM225 TRI-MOTO 85-86	-	A25-2030	-	0935-0417
YTM225 TRI-MOTO DXK 83-84	-	A25-2030	-	0935-0417
YTM225 TRI-MOTO DXL 83-84	-	A25-2030	-	0935-0417
YFB250 TIMBERWOLF 92-98	-	A25-2030	-	0935-0417
YFB250FW TIMBERWOLF 94-00	A25-2026	A25-2030	0935-1033	0935-0417
YFM250 BEARTRACKER 99-04	-	A25-2033	-	0935-0418
YFM250 BIG BEAR 07-09	-	A25-2033	-	0935-0418
YFM250 MOTO-4 89-91	-	A25-2030	-	0935-0417
YFM250B BRUIN 05-06	-	A25-2033	-	0935-0418
YFM350 GRIZZLY IRS 07-11	1205-0210	1205-0255	0935-0419	0935-1037
YFM350BA BRUIN 2WD 04-06	-	A25-2033	-	0935-0418
YFM350ER MOTO-4 87-95	-	A25-2030	-	0935-0417
YFM350FA BRUIN 4WD 04-06	A25-2028	A25-2033	0935-0469	0935-0418
YFM350FGW GRIZZLY 4WD 07-14	A25-2028	A25-2033	0935-0469	0935-0418
YFM350FW BIG BEAR 87-95	A25-2026	A25-2030	0935-1033	0935-0417
YFM350FW BIG BEAR 96-97	A25-2026	A25-2033	0935-1033	0935-0418
YFM350FW BIG BEAR 98-99	A25-2001	A25-2033	0935-0406	0935-0418
YFM350GW GRIZZLY 2WD 07-11	-	A25-2033	-	0935-0418
YFM350U BIG BEAR 96-99	-	A25-2033	-	0935-0418
YFM35FX WOLVERINE 95-97	-	A25-2033	0935-0406	0935-0418
YFM35FX WOLVERINE 98-05	A25-2001	A25-2033	0935-0406	0935-0418
YFM35X WOLVERINE 06-09	-	A25-2033	-	0935-0418
YFM400 BIG BEAR 2WD 00-04	-	A25-2033	-	0935-0418
YFM400 BIG BEAR 4WD 00-01	A25-2001	A25-2033	0935-0406	0935-0418
YFM400 BIG BEAR 4WD 02-06	A25-2028	A25-2033	0935-0469	0935-0418
YFM400 BIG BEAR IRS 07-12	1205-0210	1205-0255	0935-0419	0935-1037
YFM400 GRIZZLY IRS 07-08	A25-2028	1205-0256	0935-0469	-
YFM400 KODIAK 2WD 00-04	-	A25-2033	-	0935-0418
YFM400 KODIAK 4WD 93-98	A25-2026	A25-2033	0935-1033	0935-0418
YFM400 KODIAK 4WD 99	A25-2001	A25-2033	0935-0406	0935-0418
YFM400 KODIAK 4WD 00-04	A25-2028	A25-2033	0935-0469	0935-0418
YFM400 KODIAK 4WD 05-06	A25-2028	1205-0256	0935-0469	-
450 RHINO 06-09	1205-0122	1205-0123	0935-0419	0935-0470
KODIAK 450 4WD 18-19	A25-2028	1205-0257	0935-0469	-
YFM450 GRIZZLY EPS 11-14	1205-0210	1205-0257	0935-0419	0935-1037

FITS MODEL	BEARING & SEAL KIT FRONT #	BEARING & SEAL KIT REAR #	SEAL ONLY KIT FRONT #	SEAL ONLY KIT REAR #
DIFFERENTIAL BEARINGS AND SEAL KITS (CON'T)				
YAMAHA (CON'T)				
YFM450 GRIZZLY IRS 07	1205-0122	1205-0256	0935-0419	-
YFM450 GRIZZLY IRS 08-10	1205-0210	1205-0255	0935-0419	0935-1037
YFM450 GRIZZLY IRS 11-14	1205-0210	1205-0257	0935-0419	0935-1037
YFM450 KODIAK 03-04	1205-0122	A25-2033	0935-0419	0935-0418
YFM450 KODIAK 05-06	1205-0122	1205-0256	0935-0419	-
YFM45FX WOLVERINE 450 4X4 06-10	A25-2028	A25-2033	0935-0469	0935-0418
YFM550 GRIZZLY 09-14	1205-0210	1205-0211	0935-0419	0935-0610
YFM600 GRIZZLY 98-01	-	A25-2033	-	0935-0418
660 RHINO 04-07	1205-0122	1205-0123	0935-0419	0935-0470
YFM660 GRIZZLY 02-08	1205-0122	1205-0123	0935-0419	0935-0470
700 RHINO FI 08-13	1205-0210	1205-0123	0935-0419	0935-0470
KODIAK 700 4WD 16-19	1205-0210	1205-0287	0935-0419	0935-1005
KODIAK 700 EPS 4WD 16	1205-0210	1205-0211	0935-0419	0935-0610
KODIAK 700 EPS 4WD 17-19	1205-0210	1205-0287	0935-0419	0935-1005
KODIAK 700 EPS 4WD SE 18-19	1205-0210	1205-0287	0935-0419	0935-1005
VIKING 700 14-19	1205-0210	-	0935-0419	-
VIKING 700 VI EPS 15-19	1205-0210	-	0935-0419	-
WOLVERINE 16-18	1205-0210	-	0935-0419	-
YFM700 GRIZZLY EPS 07-19	1205-0210	1205-0211	0935-0419	0935-0610
YXZ1000R EPS 16-19	1205-0210	-	0935-0419	-



INDEPENDENT REAR SUSPENSION KITS

Cost-effective kit containing all of the parts required to rebuild one side of a rear suspension. Includes all bearings, bushings, seals, shafts and all components to repair the rear upper and lower A-arm and knuckle. Two kits required per vehicle.



FITS MODEL	SUSPENSION KIT PART #	KNUCKLE ONLY PART #	SUSPENSION BUSHING ONLY PART #
INDEPENDENT REAR SUSPENSION KITS			
ARCTIC CAT			
400 400 FIS 2X4 W/AT 04	0430-0825	-	0430-0624
400 FIS 4X4 TRV 06-14	0430-0825	-	0430-0624
400 FIS 4X4 W/AT/MT 04-08	0430-0825	-	0430-0624
400 TBX 4X4 05-06	0430-0825	-	0430-0624
450 HI 10-11	0430-0825	-	0430-0624
450 TRV 12	0430-0825	-	0430-0624
450I EFI 12	0430-0825	-	0430-0624
450I TRV EFI 11-12	0430-0825	-	0430-0624
450I TRV GT EFI 12	0430-0825	-	0430-0624
500 EFI 4X4 W/AT 13-17	0430-0825	-	0430-0624
500 FIS 4X4 W/AT/MT 04-09	0430-0825	-	0430-0624
500 FIS TBX 4X4 05-06	0430-0825	-	0430-0624
500 FIS TRV 4X4 05-08	0430-0825	-	0430-0624
500 TRV 13-15	0430-0825	-	0430-0624
500 XT EFI 13-14	0430-0825	-	0430-0624
ALTERRA TRV 500 17	0430-0825	-	-
PROWLER 500 HDX 14-15	0430-0825	-	0430-0624
PROWLER 500 HDX XT 17	0430-0825	-	0430-0624
550 EFI 4X4 12-13	0430-0825	-	0430-0624
550 GT EFI 4X4 12	0430-0825	-	0430-0624
550 HI FIS 4X4 09-11	0430-0825	-	0430-0624
550 TRV 4X4 W/AT 09-13	0430-0825	-	0430-0624
550 TRV XT/LTD 14-15	0430-0825	-	0430-0624
550 XT EFI 4X4 13-14	0430-0825	-	0430-0624
550 XT LTD EFI 12-14	0430-0825	-	0430-0624
ALTERRA TRV 550 XT EPS 17	0430-0825	-	0430-0624
PROWLER 550 09-15	0430-0825	-	0430-0624
650 4X4 HI 05-11	0430-0825	-	0430-0624
650 4X4 HI MUD PRO 10-11	0430-0825	-	0430-0624
650 4X4 W/AT V2 04-06	0430-0825	-	0430-0624
650 HI TBX 07-09	0430-0825	-	0430-0624
650 TRV 09	0430-0825	-	0430-0624
650I 4X4 12	0430-0825	-	0430-0624
PROWLER 650 07	0430-0825	-	0430-0624
PROWLER 650 XT 06-09	0430-0825	-	0430-0624
700 AT EFI 06	0430-0825	-	0430-0624
700 DIESEL 07-15	0430-0825	-	0430-0624
700 EFI 07-08	0430-0825	-	0430-0624
700 EFI / LTD 11-14	0430-0825	-	0430-0624
700 EFI HI 08-11	0430-0825	-	0430-0624
700 EFI HI MUDPRO 09-11	0430-0825	-	0430-0624
700 GT EFI 12	0430-0825	-	0430-0624
700 LTD EFI 13	0430-0825	-	0430-0624
700 TBX 10-17	0430-0825	-	0430-0624
700 TRV 08-15	0430-0825	-	0430-0624
700 XT 13-14	0430-0825	-	0430-0624
700I EFI MUDPRO / LTD 12-15	0430-0825	-	0430-0624
700I HI TRV GT EFI 11-12	0430-0825	-	0430-0624
ALTERRA TRV 700 XT EPS 17	0430-0825	-	0430-0624
PROWLER 700 CREW HDX XT 17	0430-0825	-	0430-0624
PROWLER 700 XT 08-14	0430-0825	-	0430-0624
1000 LTD MUDPRO 15-17	0430-0825	-	0430-0624
1000 TRV 13	0430-0825	-	0430-0624
1000 TRV / CRUISER 09-12	0430-0825	-	0430-0624
1000 TRV GT 12	0430-0825	-	0430-0624
1000 TRV XT/LTD 15	0430-0825	-	0430-0624
1000 XT 13-17	0430-0825	-	0430-0624
1000I GT 12	0430-0825	-	0430-0624
1000I LTD EFI MUDPRO 12-14	0430-0825	-	0430-0624
ALTERRA TRV 1000 XT 17	0430-0825	-	0430-0624
H2 MUDPRO 10-11	0430-0825	-	0430-0624
H2 THUNDERCAT 08-11	0430-0825	-	0430-0624
PROWLER 1000 XT 15-17	0430-0825	-	0430-0624
PROWLER 1000 XTZ H2 09-11	0430-0825	-	0430-0624

FITS MODEL

INDEPENDENT REAR SUSPENSION KITS (CONT)

CAN-AM

FITS MODEL	SUSPENSION KIT PART #	KNUCKLE ONLY PART #	SUSPENSION BUSHING ONLY PART #
OUTLANDER 330 04-05	0430-0603	-	-
OUTLANDER 400 (ALL) 03-04	0430-0603	-	-
OUTLANDER DPS 450 EFI 16-19	0430-0681	-	-
OUTLANDER L 450 EFI 15-16	0430-0681	-	-
OUTLANDER L MAX 450 EFI 15-16	0430-0681	-	-
OUTLANDER MAX 450 GX6 19	0430-0681	-	-
OUTLANDER MAX 450 EFI 17	0430-0681	-	-
OUTLANDER MAX DPS 450 EFI 16-19	0430-0681	-	-
OUTLANDER STD 450 EFI 17-19	0430-0681	-	-
DEFENDER 500 17-19	0430-0985	-	-
OUTLANDER 500 STD 4X4 07-12	0430-0603	-	-
OUTLANDER 500 STD 4X4 13-15	0430-0681	-	-
OUTLANDER 500 XT 4X4 07-12	0430-0603	-	-
OUTLANDER 500 XT 4X4 13-14	0430-0681	-	-
OUTLANDER L 500 EFI 15	0430-0681	-	-
OUTLANDER L MAX 500 EFI 15	0430-0681	-	-
OUTLANDER MAX 500 EFI 15	0430-0681	-	-
OUTLANDER MAX 500 STD 4X4 07-12	0430-0603	-	-
OUTLANDER MAX 500 STD 4X4 13-14	0430-0681	-	-
OUTLANDER MAX 500 XT 4X4 07-12	0430-0603	-	-
OUTLANDER MAX 500 XT 4X4 13-14	0430-0681	-	-
OUTLANDER DPS 570 EFI 16-19	0430-0681	-	-
OUTLANDER L 570 EFI 16	0430-0681	-	-
OUTLANDER MAX 570 EFI 16-19	0430-0681	-	-
OUTLANDER STD 570 EFI 17-19	0430-0681	-	-
OUTLANDER XMR 570 EFI 16-19	0430-0681	-	-
OUTLANDER 650 GX6 15-18	0430-0681	-	-
OUTLANDER 650 STD 4X4 06-12	0430-0603	-	-
OUTLANDER 650 STD 4X4 13-14	0430-0681	-	-
OUTLANDER 650 STD 4X4 15	0430-0681	-	-
OUTLANDER 650 XMR 13-15	0430-0681	-	-
OUTLANDER 650 XT 4X4 06-12	0430-0603	-	-
OUTLANDER 650 XT 4X4 13-14	0430-0681	-	-
OUTLANDER DPS 650 EFI 17-19	0430-0681	-	-
OUTLANDER MAX 650 GX6 19	0430-0681	-	-
OUTLANDER MAX 650 STD 4X4 06-12	0430-0603	-	-
OUTLANDER MAX 650 STD 4X4 13-15	0430-0681	-	-
OUTLANDER MAX 650 XT 4X4 06-12	0430-0603	-	-
OUTLANDER MAX 650 XT 4X4 13-14	0430-0681	-	-
OUTLANDER STD 650 EFI 17-19	0430-0681	-	-
DEFENDER 800 16-19	0430-0985	-	-
DEFENDER 800 XT 16-19	0430-0985	-	-
DEFENDER MAX 800 DPS 17-19	0430-0985	-	-
DEFENDER MAX 800 XT 17-19	0430-0985	-	-
OUTLANDER 800 STD 4X4 06-08	0430-0603	-	-
OUTLANDER 800 XMR 11-12	0430-0603	-	-
OUTLANDER 800 XT 4X4 06-08	0430-0603	-	-
OUTLANDER 800 XXC 11	0430-0603	-	-
OUTLANDER 800R STD 4X4 09-11	0430-0603	-	-
OUTLANDER 800R STD 4X4 12-14	0430-0681	-	-
OUTLANDER 800R STD 4X4 15	0430-0681	-	-
OUTLANDER 800R XMR 15	0430-0681	-	-
OUTLANDER 800R XT 4X4 09-12	0430-0603	-	-
OUTLANDER 800R XT 4X4 13-14	0430-0681	-	-
OUTLANDER MAX 800 LTD 4X4 07-08	0430-0603	-	-
OUTLANDER MAX 800 STD 4X4 06-08	0430-0603	-	-
OUTLANDER MAX 800 XT 4X4 06-08	0430-0603	-	-
OUTLANDER MAX 800R EFI 15	0430-0681	-	-
OUTLANDER MAX 800R LTD 4X4 09-12	0430-0603	-	-
OUTLANDER MAX 800R STD 4X4 12-14	0430-0681	-	-
OUTLANDER MAX 800R XT 4X4 13-14	0430-0681	-	-
OUTLANDER 850 16-19	0430-0681	-	-
OUTLANDER MAX 850 16-19	0430-0681	-	-
MAVERICK X3 900 HO 18	0430-1046	-	-
MAVERICK X3 MAX TURBO 18-19	0430-1046	-	-
MAVERICK X3 TURBO 18-19	0430-1046	-	-
DEFENDER 1000 16-19	0430-0985	-	-
DEFENDER MAX 1000 17-19	0430-0985	-	-
MAVERICK 1000 STD 13-15	0430-0780	-	-
MAVERICK 1000 STD 16-18	0430-0984	-	-
MAVERICK 1000 TURBO 16-17	0430-0984	-	-
MAVERICK 1000 TURBO XDS 15	0430-0780	-	-
MAVERICK 1000 TURBO XDS 16	0430-0984	-	-
MAVERICK 1000 XC 16-17	0430-0984	-	-

PLOWES
WINCHES
UTV
RACKS
IMPLEMENTES & TOWING
LUGGAGE
BODY
CONTROLS
ELECTRICAL
WHEELS & TIRES
SUSPENSION & DRIVE
BRAKING
ENGINE
RIDER
GARAGE
PROMO

SUSPENSION & DRIVE

FITS MODEL	SUSPENSION KIT PART #	KNUCKLE ONLY PART #	SUSPENSION BUSHING ONLY PART #
INDEPENDENT REAR SUSPENSION KITS (CON'T)			
CAN-AM (CON'T)			
MAVERICK 1000 XDS 15	0430-0780	-	-
MAVERICK 1000 XDS 16	0430-0984	-	-
MAVERICK 1000 XMR 14-15	0430-0780	-	-
MAVERICK 1000 XMR 16-18	0430-0984	-	-
MAVERICK 1000 XRS 13-15	0430-0780	-	-
MAVERICK 1000 XXC 14-15	0430-0780	-	-
MAVERICK 1000 XXC 16-17	0430-0984	-	-
MAVERICK MAX 1000 STD 14-15	0430-0780	-	-
MAVERICK MAX 1000 STD 16-18	0430-0984	-	-
MAVERICK MAX 1000 TURBO 16-17	0430-0984	-	-
MAVERICK MAX 1000 TURBO XDS 15	0430-0780	-	-
MAVERICK MAX 1000 TURBO XDS 16-17	0430-0984	-	-
MAVERICK MAX 1000 XC/XXC 16	0430-0984	-	-
MAVERICK MAX 1000 XDS 14-15	0430-0780	-	-
MAVERICK MAX 1000 XDS 16	0430-0984	-	-
MAVERICK MAX 1000 XMR 17-18	0430-0984	-	-
MAVERICK MAX 1000 XRS 14-15	0430-0780	-	-
OUTLANDER 1000 DPS 12-15	0430-0681	-	-
OUTLANDER 1000 DPS 16-19	0430-0681	-	-
OUTLANDER 1000 EFI 6X6 15-18	0430-0681	-	-
OUTLANDER 1000 XMR 13-19	0430-0681	-	-
OUTLANDER 1000 XT 12-19	0430-0681	-	-
OUTLANDER 1000 XTP 13-19	0430-0681	-	-
OUTLANDER MAX 1000 13-19	0430-0681	-	-
HONDA			
TRX420 FA IRS 09-14	-	0430-0733	-
TRX420 FA IRS 15-19	0430-1047	-	-
TRX500FA 15-19	0430-1047	-	-
TRX650 RINCON 03-14	0430-0322	0430-0617	-
TRX680 RINCON 15-19	0430-0322	0430-0617	-
KAWASAKI			
KVF650 I BRUTE FORCE 06-13	0430-0461	0430-0619	-
KVF750 BRUTE FORCE 05-19	0430-0461	0430-0619	-
TERYX 750 4X4 08-13	-	0430-0619	-
POLARIS			
LSV ELECTRIC 4X4 11-12	0430-0826	-	0430-0626
RANGER EV 4X4 10-13	0430-0826	-	0430-0626
RANGER EV 4X4 14-19	0430-0826	-	0430-0626
RANGER EV LIION 16-18	0430-0826	-	0430-0626
RANGER EV MIDSIZE INTL 14	0430-0826	-	0430-0626
HAWKEYE 2X4 06-11	0430-0827	-	0430-0676
HAWKEYE 4X4 06	-	-	0430-0676
HAWKEYE 4X4 07	0430-0827	-	0430-0676
SPORTSMAN 300 4X4 08-10	0430-0827	-	0430-0676
ACE 325 14-15	0430-0828	-	0430-0849
ACE 325 16	0430-0828	-	0430-0849
ACE 325 EU 15	0430-0828	-	0430-0849
ACE 325 HD 15	0430-0828	-	0430-0849
HAWKEYE 325 2X4 15	0430-0868	-	0430-0869
RANGER 325 ETX 15	0430-0828	-	0430-0849
RANGER 325 ETX 16	0430-0828	-	0430-0849
RANGER 325 ETX EU 15	0430-0828	-	0430-0849
SPORTSMAN 325 ETX EFI 15	0430-0829	-	0430-0620
SPORTSMAN 325 ETX EFI MD 15	0430-0868	-	0430-0869
SPORTSMAN 335 99-00	0430-0830	-	0430-0622
WORKER 335 99	0430-0830	-	0430-0622
HAWKEYE 400 HO 2X4 11-13	0430-0829	-	0430-0620
HAWKEYE 400 HO 2X4 14	0430-0829	-	0430-0620
RANGER 4X4 400 10-14	0430-0826	-	0430-0626
SPORTSMAN 400 4X4 02	0430-0830	-	0430-0622
SPORTSMAN 400 4X4 03-05	0430-0831	-	0430-0620
SPORTSMAN 400 4X4 AA AE AG 04	0430-0831	-	0430-0620
SPORTSMAN 400 4X4 AQ-AV 04	0430-0831	-	0430-0620
SPORTSMAN 400 4X4 BUILT AFTER 12/7/00 01	0430-0830	-	0430-0622
SPORTSMAN 400 4X4 BUILT BEFORE 12/7/00 01	0430-0830	-	0430-0622
SPORTSMAN 400 HO 4X4 09-10	0430-0827	-	0430-0676
SPORTSMAN 400 HO 4X4 11-14	0430-0829	-	0430-0620
SPORTSMAN 400 HO 4X4 BUILT AFTER 9/16 08	0430-0827	-	0430-0676
SPORTSMAN 400 HO 4X4 BUILT BEFORE 9/16 08	0430-0827	-	0430-0676
450 HO 2X4 MD 16	0430-0981	-	0430-0869
SPORTSMAN 450 06	0430-0831	-	0430-0620
SPORTSMAN 450 BUILT AFTER 7/25/06 07	0430-0831	-	0430-0620
SPORTSMAN 450 BUILT BEFORE 7/25/06 07	0430-0831	-	0430-0620
SPORTSMAN 450 EFI MD 16	0430-0981	-	0430-0869

FITS MODEL	SUSPENSION KIT PART #	KNUCKLE ONLY PART #	SUSPENSION BUSHING ONLY PART #
INDEPENDENT REAR SUSPENSION KITS (CON'T)			
POLARIS (CON'T)			
SPORTSMAN 450 EPS QUAD 16	0430-0981	-	0430-0869
SPORTSMAN 450 EPS ZUG 16	0430-0981	-	0430-0869
SPORTSMAN 450 HD 2X4 18	0430-0981	-	0430-0869
SPORTSMAN 450 HO 16	0430-0981	-	0430-0869
SPORTSMAN 450 HO 17-19	0430-0982	-	0430-0620
SPORTSMAN 450 HO 2X4 MD 16	0430-0981	-	0430-0869
SPORTSMAN 450 TRACTOR 16	0430-0981	-	0430-0869
ACE 500 17-19	0430-0828	-	0430-0849
RANGER 2X4 500 05-09	0430-0826	-	0430-0626
RANGER 2X4 500 BUILT AFTER 1/15/07 07	0430-0826	-	0430-0626
RANGER 2X4 500 BUILT AFTER 8/28/06 07	0430-0826	-	0430-0626
RANGER 2X4 500 BUILT BEFORE 1/15/07 07	0430-0826	-	0430-0626
RANGER 2X4 500 BUILT BEFORE 8/28/06 07	0430-0826	-	0430-0626
RANGER 4X4 500 06	0430-0826	-	0430-0626
RANGER 4X4 500 BUILT AFTER 1/15/07 07	0430-0826	-	0430-0626
RANGER 4X4 500 BUILT AFTER 8/28/06 07	0430-0826	-	0430-0626
RANGER 4X4 500 BUILT BEFORE 1/15/07 07	0430-0826	-	0430-0626
RANGER 4X4 500 BUILT BEFORE 8/28/06 07	0430-0826	-	0430-0626
RANGER 4X4 500 CREW 11-13	0430-0826	-	0430-0626
RANGER 4X4 500 EFI 06-08	0430-0826	-	0430-0626
RANGER 4X4 500 EFI 09-10	0430-0826	-	0430-0626
RANGER 4X4 500 EFI 11-13	0430-0826	-	0430-0626
RANGER 4X4 500 EFI BUILT AFTER 8/28/06 07	0430-0826	-	0430-0626
RANGER 4X4 500 EFI BUILT BEFORE 8/28/06 07	0430-0826	-	0430-0626
RANGER 500 2WD 17-19	0430-0828	-	0430-0849
RANGER 500 4X4 19	0430-0828	-	0430-0849
RANGER 500 ETX 17	0430-0828	-	0430-0849
SPORTSMAN 500 4X4 96-00	0430-0830	-	0430-0622
SPORTSMAN 500 4X4 BUILT AFTER 9/98 99	0430-0830	-	0430-0622
SPORTSMAN 500 4X4 BUILT BEFORE 9/98 99	0430-0830	-	0430-0622
SPORTSMAN 500 4X4 DUSE 01-02	0430-0830	-	0430-0622
SPORTSMAN 500 4X4 DUSE HO 01	0430-0830	-	0430-0622
SPORTSMAN 500 4X4 HO 01	0430-0830	-	0430-0620
SPORTSMAN 500 4X4 HO 02	-	-	0430-0620
SPORTSMAN 500 4X4 HO 03-10	0430-0831	-	0430-0620
SPORTSMAN 500 4X4 HO 11-13	0430-0829	-	0430-0620
SPORTSMAN 500 4X4 HO AA-AC-AE-AG 04	0430-0831	-	0430-0620
SPORTSMAN 500 4X4 HO AQ-AV 04	0430-0831	-	0430-0620
SPORTSMAN 500 4X4 RSE 00-01	0430-0830	-	0430-0622
SPORTSMAN 500 4X4 RSE 02	-	-	0430-0622
SPORTSMAN 500 4X4 RSE BUILT AFTER 9/98 99	0430-0830	-	0430-0622
SPORTSMAN 500 4X4 RSE BUILT BEFORE 9/98 99	0430-0830	-	0430-0622
SPORTSMAN 500 EFI 06-09	0430-0831	-	0430-0620
SPORTSMAN 500 TRACTOR EFI 09	0430-0831	-	0430-0620
SPORTSMAN 500 TRACTOR EFI BUILT AFTER 6/23/09	0430-0831	-	0430-0620
SPORTSMAN 500 TRACTOR EFI BUILT BEFORE 6/23/09	0430-0831	-	0430-0620
SPORTSMAN 500 X2 07	0430-0832	-	0430-0621
SPORTSMAN 500 X2 08-09	0430-0833	-	0430-0623
SPORTSMAN FOREST 500 11-13	0430-0829	-	0430-0620
SPORTSMAN FOREST 500 TRACTOR 11-13	0430-0829	-	0430-0620
SPORTSMAN FOREST 500 TRACTOR 14	0430-0868	-	0430-0869
SPORTSMAN TOURING 500 08-13	0430-0833	-	0430-0623
WORKER 500 4X4 00-02	0430-0830	-	0430-0622
WORKER 500 4X4 BUILT AFTER 9/98 99	0430-0830	-	0430-0622
WORKER 500 4X4 BUILT BEFORE 9/98 99	0430-0830	-	0430-0622
XPLORER 500 97	0430-0830	-	0430-0622
SPORTSMAN 550 11	0430-0834	-	0430-0735
SPORTSMAN 550 12-13	0430-0835	-	0430-0734
SPORTSMAN 550 EPS 10	0430-0836	-	-
SPORTSMAN 550 EPS 11	0430-0834	-	0430-0735
SPORTSMAN 550 EPS 12-13	0430-0835	-	0430-0734
SPORTSMAN 550 EPS 14	0430-0837	-	0430-0850
SPORTSMAN 550 X2 10	0430-0838	-	-
SPORTSMAN 550 X2 11	0430-0834	-	0430-0735
SPORTSMAN 550 X2 12-13	0430-0835	-	0430-0734
SPORTSMAN 550 X2 14	0430-0837	-	0430-0850
SPORTSMAN 550 X2 EPS LE 14	0430-0844	-	0430-0853
SPORTSMAN 550 X2 INTL 14	-	-	0430-0854
SPORTSMAN 550 XP 10	0430-0839	-	0430-0737
SPORTSMAN 550 XP 13	0430-0835	-	0430-0734
SPORTSMAN 550 XP 14	0430-0837	-	0430-0850
SPORTSMAN 550 XP BUILT AFTER 12/1/08 09	0430-0839	-	0430-0737
SPORTSMAN 550 XP BUILT BEFORE 12/1/08 09	0430-0839	-	0430-0737
SPORTSMAN 550 XP EPS HD INTL 14	-	-	0430-0854

FITS MODEL	SUSPENSION KIT PART #	KNUCKLE ONLY PART #	SUSPENSION BUSHING ONLY PART #
INDEPENDENT REAR SUSPENSION KITS (CON'T)			
POLARIS (CON'T)			
SPORTSMAN FOREST 550 11	0430-0834	-	0430-0735
SPORTSMAN FOREST 550 12	0430-0835	-	0430-0734
SPORTSMAN FOREST 550 13	0430-0837	-	0430-0850
SPORTSMAN FOREST 550 14	0430-0835	-	0430-0734
SPORTSMAN TOURING 550 EPS 10	0430-0838	-	-
SPORTSMAN TOURING 550 EPS 11-12	0430-0834	-	0430-0735
SPORTSMAN TOURING 550 EPS 13	0430-0835	-	-
SPORTSMAN TOURING 550 EPS 14	0430-0837	-	0430-0850
ACE 570 15	0430-0828	-	0430-0849
ACE 570 16-17	0430-0828	-	0430-0849
ACE 570 18-19	0430-0828	-	0430-0849
ACE 570 EU 15	0430-0828	-	0430-0849
ACE 570 EU 16-18	0430-0828	-	0430-0849
ACE 570 HD 15	0430-0828	-	0430-0849
ACE 570 HD 16-19	0430-0828	-	0430-0849
ACE 570 MD 16	0430-0828	-	0430-0849
RANGER 570 14-19	0430-0828	-	0430-0849
RANGER 570 CREW 14-19	0430-0828	-	0430-0849
RANGER 570 CREW EPS 14-19	0430-0828	-	0430-0849
RANGER 570 EPS 14-19	0430-0828	-	0430-0849
RANGER 570 EU 15-16	0430-0828	-	0430-0849
RANGER 570 FULL SIZE 15-16	0430-0828	-	0430-0849
RANGER 570 FULL SIZE 17-19	0430-0828	-	0430-0849
RANGER 570 FULL SIZE CREW 15	0430-0828	-	0430-0849
RANGER 570 FULL SIZE CREW 16	0430-0828	-	0430-0849
RANGER 570 FULL SIZE WITH STRUT 16	0430-0828	-	0430-0849
RANGER 570 HD 19	0430-0828	-	0430-0849
RANGER 570 INTL 14	0430-0828	-	0430-0849
RANGER 570 XP 16	0430-0828	-	0430-0849
RANGER 570-6 FULL SIZE CREW 16-19	0430-0828	-	0430-0849
RZR 570 EFI 12-13	0430-0840	-	0430-0682
RZR 570 EFI 14-19	0430-0828	-	0430-0849
RZR 570 EFI EPS 19	0430-0828	-	0430-0849
RZR 570 EPS 18	0430-0828	-	0430-0849
RZR 570 EU 15-18	0430-0828	-	0430-0849
RZR 570 S 17	0430-0828	-	0430-0849
SPORTSMAN 570 6X6 17-19	0430-0829	-	0430-0620
SPORTSMAN 570 EFI 14-15	0430-0829	-	0430-0620
SPORTSMAN 570 EFI X2 EPS 15	0430-0829	-	0430-0620
SPORTSMAN 570 EFI EPS MD 15	0430-0868	-	0430-0869
SPORTSMAN 570 EFI HD 16-18	0430-0981	-	0430-0869
SPORTSMAN 570 EFI 16-19	0430-0982	-	0430-0620
SPORTSMAN 570 EFI X2 EPS 16-19	0430-0982	-	0430-0620
SPORTSMAN 570 SP 16-19	0430-0982	-	0430-0620
SPORTSMAN TOURING 570 EFI 14-15	0430-0868	-	0430-0869
SPORTSMAN TOURING 570 EFI EPS MD 16	0430-0981	-	0430-0869
SPORTSMAN TOURING 570 EPS QUAD 16	0430-0981	-	0430-0869
SPORTSMAN TOURING 570 EFI 16-19	0430-0982	-	0430-0620
SPORTSMAN TOURING 570 EFI EPS 16	0430-0982	-	0430-0620
SPORTSMAN TOURING 570 EFI EPS MD 17	0430-0982	-	0430-0620
SPORTSMAN TOURING 570 SP 15	0430-0982	-	0430-0620
SPORTSMAN TOURING 570 SP 16-19	0430-0982	-	0430-0620
SPORTSMAN 600 4X4 03-05	0430-0831	-	0430-0620
RANGER 4X4 700 05-08	0430-0826	-	0430-0626
RANGER 4X4 700 09	0430-0826	-	0430-0626
RANGER 4X4 700 CREW 08-09	0430-0826	-	0430-0626
RANGER 6X6 700 EFI 08-09	0430-0826	-	0430-0626
SPORTSMAN 700 4X4 02-07	0430-0831	-	0430-0620
SPORTSMAN 700 EFI 05-07	0430-0831	-	0430-0620
SPORTSMAN MV7 05	0430-0831	-	0430-0620
SPORTSMAN X2 700 EFI 08	0430-0833	-	0430-0623
RANGER 4X4 800 EFI 10-14	0430-0826	-	0430-0626
RANGER 4X4 800 EFI CREW 10-14	0430-0826	-	0430-0626
RANGER 4X4 800 EFI MIDSIZE 13	0430-0826	-	0430-0626
RANGER 4X4 800 EFI MIDSIZE 14	0430-0826	-	0430-0626
RANGER 6X6 800 10-16	0430-0826	-	0430-0626
RANGER XP 800 12	0430-0826	-	0430-0626
RZR 4 800 10-13	0430-0855	-	0430-0679
RZR 4 800 14	0430-0842	-	0430-0851
RZR 800 08-12	0430-0841	-	0430-0679
RZR 800 13	0430-0855	-	0430-0679
RZR 800 14	0430-0842	-	0430-0851
RZR S 800 09-13	0430-0855	-	0430-0679
RZR S 800 14	0430-0842	-	0430-0851

FITS MODEL	SUSPENSION KIT PART #	KNUCKLE ONLY PART #	SUSPENSION BUSHING ONLY PART #
INDEPENDENT REAR SUSPENSION KITS (CON'T)			
POLARIS (CON'T)			
SPORTSMAN 800 EFI 05-10	0430-0831	-	0430-0620
SPORTSMAN 800 EFI 11-14	0430-0829	-	0430-0620
SPORTSMAN 800 EFI 6X6 09-14	-	-	0430-0852
SPORTSMAN 800 HD EFI 09	0430-0831	-	0430-0620
SPORTSMAN TOURING 800 EFI 08-09	0430-0833	-	0430-0623
SPORTSMAN X2 800 EFI 07	0430-0832	-	0430-0621
SPORTSMAN X2 800 EFI 08-09	0430-0833	-	0430-0623
SCRAMBLER 850 15-18	0430-0844	-	0430-0853
SCRAMBLER 850 EU 15	-	-	0430-0854
SCRAMBLER 850 HO/EPS 13	0430-0835	-	0430-0734
SCRAMBLER 850 HO/EPS 14	0430-0837	-	0430-0850
SCRAMBLER 850 MD 15	0430-0844	-	0430-0853
SCRAMBLER 850 XP HO EPS 14	-	-	0430-0854
SCRAMBLER 850 XP HO EPS INTL 14	-	-	0430-0854
SPORTSMAN 850 HIGH LIFTER 17-19	0430-0844	-	0430-0853
SPORTSMAN 850 SP 15-18	0430-0844	-	0430-0853
SPORTSMAN 850 WV 14	0430-0844	-	0430-0853
SPORTSMAN 850 XP HO EPS MD 15	-	-	0430-0854
SPORTSMAN TOURING 850 15-19	0430-0844	-	0430-0853
SPORTSMAN TOURING 850 EPS 14	0430-0837	-	0430-0850
SPORTSMAN TOURING 850 INTL 14	-	-	0430-0854
SPORTSMAN TOURING 850 SP EU 15	-	-	0430-0854
SPORTSMAN TOURING 850 SP MD 15	-	-	0430-0854
SPORTSMAN TOURING EPS 850 10	0430-0834	-	0430-0735
SPORTSMAN TOURING EPS 850 11	0430-0834	-	0430-0735
SPORTSMAN TOURING EPS 850 12-13	0430-0835	-	0430-0734
SPORTSMAN TOURING EPS 850 HO 13	0430-0835	-	0430-0734
SPORTSMAN X2 850 11	0430-0834	-	0430-0735
SPORTSMAN XP 850 09	0430-0839	-	0430-0737
SPORTSMAN XP 850 10	0430-0836	-	-
SPORTSMAN XP 850 11	0430-0834	-	0430-0735
SPORTSMAN XP 850 12-13	0430-0835	-	0430-0734
SPORTSMAN XP 850 EPS 09	0430-0839	-	0430-0737
SPORTSMAN XP 850 EPS 10	0430-0836	-	-
SPORTSMAN XP 850 EPS 11	0430-0834	-	0430-0735
SPORTSMAN XP 850 EPS 12-14	0430-0835	-	0430-0734
ACE 900 EFI EPS 16	0430-0828	-	0430-0849
ACE 900 EPS XC 17-19	0430-0828	-	0430-0849
RANGER 4X4 900 DIESEL 11-14	0430-0826	-	0430-0626
RANGER 4X4 900 DIESEL CREW 12-14	0430-0826	-	0430-0626
RANGER 900 CREW 14-19	0430-0828	-	0430-0849
RANGER 900 CREW EPS 14-19	0430-0828	-	0430-0849
RANGER 900 XP 13	0430-0840	-	0430-0682
RANGER 900 XP 14	0430-0828	-	0430-0682
RANGER 900 XP 15-19	0430-0828	-	0430-0849
RANGER 900 XP EPS 19	0430-0828	-	0430-0849
RANGER 900 XP EU 15-16	0430-0828	-	0430-0849
RANGER 900D HIPPO MPS 14	0430-0826	-	0430-0626
RANGER DIESEL HST/DELUXE 14	-	-	0430-0849
RANGER DIESEL INTL 14	0430-0826	-	0430-0626
RZR 4 900 15	-	-	0430-0872
RZR 4 900 16	-	-	0430-1053
RZR 4 900 17-18	0430-1015	-	0430-1051
RZR 4 XP 900 12-13	0430-1048	-	0430-1048
RZR 4 XP 900 14	0430-1048	-	0430-1048
RZR 900 50 55 INCH 15	0430-0870	-	0430-0849
RZR 900 50 55 INCH 16	0430-0983	-	0430-1053
RZR 900 50 55 INCH 17	0430-1015	-	0430-1051
RZR 900 50 INCH 18-19	0430-1015	-	0430-1051
RZR 900 50 INCH EPS 18-19	0430-1015	-	0430-1051
RZR 900 50 INCH MD 17	0430-1015	-	0430-1051
RZR 900 60 INCH 16	0430-0983	-	0430-1053
RZR 900 60 INCH 17-19	0430-1015	-	0430-1051
RZR XP 900 11-14	0430-1048	-	0430-1050
GENERAL 1000 EPS 16-19	0430-1015	-	0430-1051
GENERAL 4 1000 EPS 17-19	0430-1015	-	0430-1051
RANGER 1000 DIESEL 15-18	0430-0828	-	0430-0849
RANGER 1000 DIESEL CREW 15-18	0430-0828	-	0430-0849
RANGER 1000 DIESEL EU 15-16	0430-0828	-	0430-0849
RANGER 1000 EPS BASE 18-19	0430-1049	-	0430-1052
RANGER 1000 EPS HD MD 19	0430-1049	-	0430-1052
RANGER HST 15-16	-	-	0430-0849
RANGER XP 1000 EPS CREW 19	0430-1049	-	0430-1052
RZR 1000 60 INCH 16	0430-0983	-	0430-1053

PLOWES
WINCHES
UTV
RACKS
IMPLEMENTES & TOWING
LUGGAGE
BODY
CONTROLS
ELECTRICAL
WHEELS & TIRES
SUSPENSION & DRIVE
BRAKING
ENGINE
RIDER
GARAGE
PROMO

SUSPENSION & DRIVE

FITS MODEL	SUSPENSION KIT PART #	KNUCKLE ONLY PART #	SUSPENSION BUSHING ONLY PART #
INDEPENDENT REAR SUSPENSION KITS (CON'T)			
POLARIS (CON'T)			
RZR 1000 60 INCH 17-19	0430-1015	-	0430-1051
RZR RS1 18-19	0430-1048	-	0430-1050
RZR S4 1000 19	0430-1015	-	0430-1051
RZR XP 1000 14-15	0430-1048	-	0430-1050
RZR XP 1000 17-19	0430-1048	-	0430-1050
RZR XP 4 1000 14-15	0430-1048	-	0430-1050
RZR XP 4 1000 17-19	0430-1048	-	0430-1050
RZR XP 4 TURBO 16-19	0430-1048	-	0430-1050
RZR XP TURBO 16-19	0430-1048	-	0430-1050
RZR XP TURBO S 18-19	0430-1048	-	0430-1050
RZR XP TURBO S4 19	0430-1048	-	0430-1050
SPORTSMAN 1000 HIGH LIFTER 16-19	0430-0844	-	0430-0853
SPORTSMAN 1000 MD 15	-	-	0430-0854
SPORTSMAN 1000 XP 15-18	0430-0844	-	0430-0853
SPORTSMAN TOURING 1000 15-19	0430-0844	-	0430-0853
SUZUKI			
LTA-450 X KING QUAD 07	0430-0460	0430-0618	-
LTA-450 X KING QUAD 08-10	0430-0564	-	-
LT-A500X 09-18	0430-0677	0430-0678	-
LTA-700 X KING QUAD 05-07	0430-0460	0430-0618	-
LTA-750 X KING QUAD 08-18	0430-0677	0430-0678	-
TEXTRON			
700 TBX 18	0430-0825	-	0430-0624
ALTERRA 700 VLX 18	0430-0825	-	-
ALTERRA 700 VLX EPS 18	0430-0825	-	-
YAMAHA			
YFM350 GRIZZLY IRS 07-11	0430-0310	0430-0616	-
YFM400 BIG BEAR IRS 07-12	0430-0310	0430-0616	-
YFM400 GRIZZLY IRS 07-08	0430-0310	0430-0616	-
YFM400 KODIAK 4WD 05-06	0430-0310	0430-0616	-
450 RHINO 06-09	0430-0310	0430-0616	-
KODIAK 450 4WD 18-19	0430-0310	0430-0616	-
KODIAK 450 EPS 4WD 18-19	0430-0310	0430-0616	-
YFM450 GRIZZLY EPS 11-14	0430-0310	0430-0616	-
YFM450 GRIZZLY IRS 07-14	0430-0310	0430-0616	-
YFM450 KODIAK 05-06	0430-0310	0430-0616	-
YFM550 GRIZZLY 09-14	0430-0310	0430-0616	-
YFM550 GRIZZLY EPS 09-14	0430-0310	0430-0616	-
660 RHINO 04-07	0430-0310	0430-0616	-
YFM660 GRIZZLY 02-08	0430-0310	0430-0616	-
700 RHINO FI 08-13	0430-0310	0430-0616	-
KODIAK 700 4WD 16-19	0430-0310	0430-0616	-
KODIAK 700 EPS 4WD 16-19	0430-0310	0430-0616	-
KODIAK 700 EPS 4WD SE 18-19	0430-0310	0430-0616	-
VIKING 700 14-17	0430-0949	0430-0948	-
VIKING 700 18-19	0430-1044	0430-1045	-
VIKING 700 EPS 18	0430-1044	0430-1045	-
VIKING 700 VI EPS 15-17	0430-0949	0430-0948	-
VIKING 700 VI EPS 18-19	0430-1044	0430-1045	-
WOLVERINE 16-18	0430-0949	0430-0948	-
WOLVERINE EPS 17	0430-0949	0430-0948	-
WOLVERINE R-SPEC 16	0430-0949	0430-0948	-
WOLVERINE R-SPEC EPS 16-18	0430-0949	0430-0948	-
WOLVERINE R-SPEC EPS SE 16-17	0430-0949	0430-0948	-
YFM700 GRIZZLY 07-16	0430-0310	0430-0616	-
YFM700 GRIZZLY EPS 08-19	0430-0310	0430-0616	-
YFM700 GRIZZLY EPS LE 18	0430-0310	0430-0616	-
YFM700 GRIZZLY EPS SE 18-19	0430-0310	0430-0616	-
WOLVERINE X2 19	0430-1044	0430-1045	-
WOLVERINE X2 R-SPEC 19	0430-1044	0430-1045	-
WOLVERINE X4 18-19	0430-1044	0430-1045	-
WOLVERINE X4 SE 18-19	0430-1044	0430-1045	-
YXZ1000R EPS 16-19	0430-0950	0430-0947	-

FRONT A-ARM BEARING AND SEAL KITS

OEM replacement designed to rebuild the A-arm to factory specification. Contains bearings, pins, spacers and seals.



FITS MODEL	LOWER BEARING PART #	UPPER BEARING PART #	LOWER BUSHING PART #	UPPER BUSHING PART #
FRONT A-ARM BEARING AND SEAL KITS				
ARCTIC CAT				
250 4X4 99-05	0430-0313	0430-0313	-	-
300 4X4 98-05	0430-0313	0430-0313	-	-
375 2X4/4X4 W/AT 02	0430-0313	0430-0809	-	0430-0631
400 2X4 98-01	0430-0313	0430-0313	-	-
400 4X4 98-00	0430-0313	0430-0313	-	-
400 4X4 W/AT 03-04	0430-0313	0430-0809	-	0430-0631
400 4X4 W/MT 01	0430-0313	0430-0313	-	-
400 4X4 W/MT 02-04	0430-0313	0430-0809	-	0430-0631
400 FIS 2X4 W/AT 03	0430-0313	0430-0809	-	0430-0631
400 FIS 2X4 W/AT 04	0430-0810	0430-0809	0430-0630	0430-0631
400 FIS 2X4 W/MT 03	0430-0313	0430-0809	-	0430-0631
400 FIS 2X4 W/MT 04	0430-0810	0430-0809	0430-0630	0430-0631
400 FIS 4X4 TRV 06-14	0430-0810	0430-0809	0430-0630	0430-0631
400 FIS 4X4 W/AT 03	0430-0313	0430-0809	-	0430-0631
400 FIS 4X4 W/AT 04-08	0430-0810	0430-0809	0430-0630	0430-0631
400 FIS 4X4 W/MT 02-03	0430-0313	0430-0809	-	0430-0631
400 FIS 4X4 W/MT 04-08	0430-0810	0430-0809	0430-0630	0430-0631
400 TBX 4X4 04	0430-0313	0430-0809	-	0430-0631
400 TBX 4X4 05-06	0430-0810	0430-0809	0430-0630	0430-0631
400 VP 4X4 W/AT 05-06	0430-0313	0430-0809	-	0430-0631
450 H1 10-11	0430-0810	0430-0809	0430-0630	0430-0631
450 TRV 12	0430-0810	0430-0809	0430-0630	0430-0631
450I EFI 12	0430-0810	0430-0809	0430-0630	0430-0631
450I TRV EFI 11-12	0430-0810	0430-0809	0430-0630	0430-0631
450I TRV GT EFI 12	0430-0810	0430-0809	0430-0630	0430-0631
454 4X4 96-98	0430-0313	0430-0313	-	-
500 4X4 98-99	0430-0313	0430-0313	-	-
500 4X4 W/AT 00-01	0430-0313	0430-0313	-	-
500 4X4 W/AT 02	0430-0313	0430-0809	-	0430-0631
500 4X4 W/MT 00-01	0430-0313	0430-0313	-	-
500 EFI 4X4 W/AT 13-17	0430-0810	0430-0809	0430-0630	0430-0631
500 FIS 4X4 W/AT 02-03	0430-0313	0430-0809	-	0430-0631
500 FIS 4X4 W/AT 04-09	0430-0810	0430-0809	0430-0630	0430-0631
500 FIS 4X4 W/MT 02-03	0430-0313	0430-0809	-	0430-0631
500 FIS 4X4 W/MT 04-09	0430-0810	0430-0809	0430-0630	0430-0631
500 FIS TBX 4X4 02-04	0430-0313	0430-0809	-	0430-0631
500 FIS TBX 4X4 05-06	0430-0810	0430-0809	0430-0630	0430-0631
500 FIS TRV 4X4 03-04	0430-0313	0430-0809	-	0430-0631
500 FIS TRV 4X4 05-08	0430-0810	0430-0809	0430-0630	0430-0631
500 TRV 13-15	0430-0810	0430-0809	0430-0630	0430-0631
500 XR 15	0430-0810	0430-0809	0430-0630	0430-0631
500 XT EFI 13-14	0430-0810	0430-0809	0430-0630	0430-0631
ALTERRA 500 XT EPS 16	0430-0810	0430-0809	0430-0630	0430-0631
ALTERRA TRV 500 17	0430-0810	0430-0809	0430-0630	0430-0631
PROWLER 500 HDX 14-15	0430-0810	0430-0810	0430-0630	0430-0630
PROWLER 500 HDX XT 17	0430-0810	0430-0810	0430-0630	0430-0630
550 EFI 4X4 12-13	0430-0810	0430-0809	0430-0630	0430-0631
550 GT EFI 4X4 12	0430-0810	0430-0809	0430-0630	0430-0631
550 H1 FIS 4X4 09-11	0430-0810	0430-0809	0430-0630	0430-0631
550 TRV 4X4 W/AT 09-13	0430-0810	0430-0809	0430-0630	0430-0631
550 TRV XT/LTD 14-15	0430-0810	0430-0809	0430-0630	0430-0631
550 XR EFI/XT/LTD 15	0430-0810	0430-0809	0430-0630	0430-0631
550 XT EFI 4X4 13-14	0430-0810	0430-0809	0430-0630	0430-0631
550 XT LTD EFI 12-14	0430-0810	0430-0809	0430-0630	0430-0631
ALTERRA TRV 550 XT EPS 16-17	0430-0810	0430-0809	0430-0630	0430-0631
PROWLER 550 09-15	0430-0810	0430-0809	0430-0630	0430-0631
650 4X4 H1 05-11	0430-0810	0430-0809	0430-0630	0430-0631
650 4X4 W/AT V2 04-06	0430-0810	0430-0809	0430-0630	0430-0631
650 H1 TBX 07-09	0430-0810	0430-0809	0430-0630	0430-0631
650 TRV 09	0430-0810	0430-0809	0430-0630	0430-0631
650I 4X4 12	0430-0810	0430-0809	0430-0630	0430-0631
PROWLER 650 07	0430-0810	0430-0809	0430-0630	0430-0631
PROWLER 650 XT 06-09	0430-0810	0430-0809	0430-0630	0430-0631
700 AT EFI 06	0430-0810	0430-0809	0430-0630	0430-0631
700 DIESEL 07-15	0430-0810	0430-0809	0430-0630	0430-0631
700 EFI 07-08	0430-0810	0430-0809	0430-0630	0430-0631

FITS MODEL	LOWER BEARING PART #	UPPER BEARING PART #	LOWER BUSHING PART #	UPPER BUSHING PART #
FRONT A-ARM BEARING AND SEAL KITS (CON'T)				
ARCTIC CAT (CON'T)				
700 EFI/LTD 11-14	0430-0810	0430-0809	0430-0630	0430-0631
700 EFI H1 08-11	0430-0810	0430-0809	0430-0630	0430-0631
700 GT EFI 12	0430-0810	0430-0809	0430-0630	0430-0631
700 LTD EFI 13	0430-0810	0430-0809	0430-0630	0430-0631
700 TBX 10-17	0430-0810	0430-0809	0430-0630	0430-0631
700 TRV 08-15	0430-0810	0430-0809	0430-0630	0430-0631
700 XR 15	0430-0810	0430-0809	0430-0630	0430-0631
700 XT 13-14	0430-0810	0430-0809	0430-0630	0430-0631
700I EFI MUDPRO/LTD 12-15	0430-0810	0430-0809	0430-0630	0430-0631
700I H1 TRV GT EFI 11-12	0430-0810	0430-0809	0430-0630	0430-0631
ALTERRA 700 16-17	0430-0810	0430-0809	0430-0630	0430-0631
ALTERRA TRV 700 XT EPS 17	0430-0810	0430-0809	0430-0630	0430-0631
PROWLER 700 CREW HDX XT 17	0430-0810	0430-0810	0430-0630	0430-0630
PROWLER 700 HDX 12-17	0430-0810	0430-0810	0430-0630	0430-0630
PROWLER 700 XT 09	0430-0810	0430-0809	0430-0630	0430-0631
PROWLER 700 XT 15-17	0430-0810	0430-0810	0430-0630	0430-0630
PROWLER 700 XT 08-14	0430-0810	0430-0809	0430-0630	0430-0631
WILDCAT SPORT 15-17	-	0430-0946	-	-
WILDCAT TRAIL 17	0430-0942	-	-	-
WILDCAT TRAIL/XT 14-17	0430-0942	0430-0945	-	-
1000 LTD MUDPRO 15-17	0430-0810	0430-0809	0430-0630	0430-0631
1000 TRV 13	0430-0810	0430-0809	0430-0630	0430-0631
1000 TRV/CRUISER 09-12	0430-0810	0430-0809	0430-0630	0430-0631
1000 TRV GT 12	0430-0810	0430-0809	0430-0630	0430-0631
1000 TRV XT/LTD 15	0430-0810	0430-0809	0430-0630	0430-0631
1000 XT 13-17	0430-0810	0430-0809	0430-0630	0430-0631
1000I GT 12	0430-0810	0430-0809	0430-0630	0430-0631
1000I LTD EFI MUDPRO 12-14	0430-0810	0430-0809	0430-0630	0430-0631
ALTERRA TRV 1000 XT 17	0430-0810	0430-0809	0430-0630	0430-0631
H2 MUDPRO 10-11	0430-0810	0430-0809	0430-0630	0430-0631
H2 THUNDERCAT 08-11	0430-0810	0430-0809	0430-0630	0430-0631
PROWLER 1000 XT 15-17	0430-0810	0430-0810	0430-0630	0430-0630
PROWLER 1000 XTZ 11-14	0430-0810	0430-0810	0430-0630	0430-0630
PROWLER 1000 XTZ H2 09-11	0430-0810	0430-0810	0430-0630	0430-0630
WILDCAT 1000 14-15	0430-0811	0430-0811	-	-
WILDCAT 4 13	0430-0812	0430-0812	-	-
WILDCAT 4 14	0430-0811	0430-0811	-	-
WILDCAT 4 LTD 14	0430-0811	0430-0811	-	-
WILDCAT 4X 14-15	0430-0811	0430-0811	-	-
WILDCAT GT 12-13	0430-0812	0430-0812	-	-
WILDCAT LTD 13	0430-0812	0430-0812	-	-
WILDCAT LTD 14	0430-0811	0430-0811	-	-
WILDCAT X 13	0430-0812	0430-0812	-	-
WILDCAT X/LTD 14-16	0430-0811	0430-0811	-	-
CAN-AM				
OUTLANDER 330 04-05	0430-0813	-	0430-0665	-
OUTLANDER 400 03-14	0430-0813	-	0430-0665	-
OUTLANDER MAX 400 EFI/STD/XT 06-15	0430-0813	-	0430-0665	-
OUTLANDER DPS 450 EFI 16-19	0430-0814	0430-0814	0430-0871	0430-0871
OUTLANDER L 450 EFI 15	0430-0813	0430-0813	0430-0871	0430-0871
OUTLANDER L 450 EFI 16	0430-0814	0430-0814	0430-0871	0430-0871
OUTLANDER L MAX 450 EFI 15	0430-0813	0430-0813	0430-0871	0430-0871
OUTLANDER L MAX 450 EFI 16	0430-0814	0430-0814	0430-0871	0430-0871
OUTLANDER MAX 450 EFI 17	0430-0814	0430-0814	0430-0871	0430-0871
OUTLANDER MAX 450 6X6 19	0430-0814	0430-0814	0430-0871	0430-0871
OUTLANDER MAX STD 450 EFI 18-19	0430-0814	0430-0814	0430-0871	0430-0871
OUTLANDER STD 450 EFI 17-19	0430-0814	0430-0814	0430-0871	0430-0871
DEFENDER 500 17-19	0430-0814	0430-0814	0430-0871	0430-0871
OUTLANDER 500 STD 4X4 07-12	0430-0813	-	0430-0665	-
OUTLANDER 500 STD 4X4 13-14	0430-0813	0430-0813	0430-0665	0430-0665
OUTLANDER 500 STD 4X4 15	0430-0814	0430-0814	0430-0871	0430-0871
OUTLANDER 500 XT 4X4 13-14	0430-0813	0430-0813	0430-0665	0430-0665
OUTLANDER L 500 EFI 15	0430-0813	0430-0813	0430-0871	0430-0871
OUTLANDER MAX 500 STD 4X4 07-12	0430-0813	-	0430-0665	-
OUTLANDER L MAX 500 EFI 15	0430-0813	0430-0813	0430-0871	0430-0871
OUTLANDER MAX 500 STD 4X4 13-14	0430-0813	0430-0813	0430-0665	0430-0665
OUTLANDER MAX 500 EFI 15	0430-0814	0430-0814	0430-0871	0430-0871
QUEST 500 02-04	0430-0813	0430-0813	0430-0665	0430-0665
TRAXTER 500 01-05	0430-0813	0430-0813	0430-0665	0430-0665
OUTLANDER DPS 570 EFI 16-19	0430-0814	0430-0814	0430-0871	0430-0871
OUTLANDER L 570 EFI 16	0430-0814	0430-0814	0430-0871	0430-0871
OUTLANDER MAX 570 EFI 16-19	0430-0814	0430-0814	0430-0871	0430-0871
OUTLANDER STD 570 EFI 17-19	0430-0814	0430-0814	0430-0871	0430-0871
OUTLANDER 650 STD 4X4 06-14	0430-0813	0430-0813	0430-0665	0430-0665

FITS MODEL	LOWER BEARING PART #	UPPER BEARING PART #	LOWER BUSHING PART #	UPPER BUSHING PART #
FRONT A-ARM BEARING AND SEAL KITS (CON'T)				
CAN-AM (CON'T)				
OUTLANDER 650 6X6 15-18	0430-0814	0430-0814	0430-0871	0430-0871
OUTLANDER 650 STD 4X4 15	0430-0814	0430-0814	0430-0871	0430-0871
OUTLANDER 650 XMR 15	0430-0814	0430-0814	0430-0871	0430-0871
OUTLANDER DPS 650 EFI 17-19	0430-0814	0430-0814	0430-0871	0430-0871
OUTLANDER MAX 650 6X6 19	0430-0814	0430-0814	0430-0871	0430-0871
OUTLANDER MAX 650 STD 4X4 06-14	0430-0813	0430-0813	0430-0665	0430-0665
OUTLANDER MAX 650 STD 4X4 15	0430-0814	0430-0814	0430-0871	0430-0871
OUTLANDER MAX 650 XT 4X4 06-14	0430-0813	0430-0813	0430-0665	0430-0665
OUTLANDER STD 650 EFI 17-19	0430-0814	0430-0814	0430-0871	0430-0871
QUEST 650 STD/XT 02-04	0430-0813	0430-0813	0430-0665	0430-0665
TRAXTER 650 04-05	0430-0813	0430-0813	0430-0665	0430-0665
COMMANDER 800 DPS 13-15	0430-0813	0430-0815	0430-0665	-
COMMANDER 800 DPS 16-19	0430-0814	0430-0815	0430-0871	-
COMMANDER MAX 800 DPS 16-19	0430-0814	0430-0815	0430-0871	-
DEFENDER 800 16-19	0430-0814	0430-0814	0430-0871	0430-0871
DEFENDER MAX 800 DPS 17-19	0430-0814	0430-0814	0430-0871	0430-0871
MAVERICK TRAIL 800R 18-19	0430-1011	0430-1011	-	-
MAVERICK TRAIL 800R DPS 18-19	0430-1011	0430-1011	-	-
OUTLANDER 800 ALL 4X4 06-14	0430-0813	0430-0813	0430-0665	0430-0665
OUTLANDER 800R STD 4X4 15	0430-0814	0430-0814	0430-0871	0430-0871
OUTLANDER 800R XMR 15	0430-0814	0430-0814	0430-0871	0430-0871
OUTLANDER MAX 800 4X4 07-14	0430-0813	0430-0813	0430-0665	0430-0665
OUTLANDER MAX 800R EFI 15	0430-0814	0430-0814	0430-0871	0430-0871
OUTLANDER 850 16-19	0430-0814	0430-0814	0430-0871	0430-0871
OUTLANDER MAX 850 16-19	0430-0814	0430-0814	0430-0871	0430-0871
MAVERICK X3 17-19 (ALL)	0430-1011	0430-1011	-	-
COMMANDER 1000 11-15 (ALL)	0430-0813	0430-0815	0430-0665	-
COMMANDER 1000 16-19 (ALL)	0430-0814	0430-0815	0430-0871	-
COMMANDER MAX 1000 14-15	0430-0813	0430-0815	0430-0665	-
COMMANDER MAX 1000 16-19	0430-0814	0430-0815	0430-0871	-
DEFENDER 1000 16-19	0430-0814	0430-0814	0430-0871	0430-0871
DEFENDER MAX 1000 17-19	0430-0814	0430-0814	0430-0871	0430-0871
MAVERICK 1000 13-18 (ALL)	0430-0816	0430-0816	-	-
MAVERICK MAX 1000 (ALL) 14-18	0430-0816	0430-0816	-	-
MAVERICK SPORT/TRAIL 1000 18-19 (ALL)	0430-1011	0430-1011	-	-
OUTLANDER 1000 12-14	0430-0813	0430-0813	0430-0665	0430-0665
OUTLANDER 1000 15-19 (ALL)	0430-0814	0430-0814	0430-0871	0430-0871
OUTLANDER MAX 1000 13-14	0430-0813	0430-0813	0430-0665	0430-0665
OUTLANDER MAX 1000 15-19	0430-0814	0430-0814	0430-0871	0430-0871
HONDA				
TRX200 90-97	0430-0312	0430-0312	-	-
TRX200D 90-97	0430-0312	0430-0312	-	-
TRX250 RECON 97-01	0430-0312	0430-0312	-	-
TRX250TE RECON 02-19	0430-0312	0430-0312	-	-
TRX250TM RECON 02-19	0430-0312	0430-0312	-	-
TRX300 FOURTRAX 88-92	0430-0312	-	-	-
TRX300 FOURTRAX 93-00	0430-0312	0430-0312	-	-
TRX300FW FOURTRAX 4X4 88-00	0430-0312	0430-0312	-	-
TRX350FE 00-06	0430-0312	0430-0312	-	-
TRX350FM FOURTRAX RANCHER 00-06	0430-0312	0430-0312	-	-
TRX350TE 00-06	0430-0312	0430-0312	-	-
TRX350TM FOURTRAX RANCHER 00-06	0430-0312	0430-0312	-	-
TRX400FA 04-07	0430-0312	0430-0312	-	-
TRX400FGA FOURTRAX RANCHER 4X4 04-07	0430-0312	0430-0312	-	-
TRX400FW FOURTRAX FOREMAN 4X4 95-03	0430-0312	0430-0312	-	-
TRX400X 09-14	0430-0044	0430-0044	-	-
TRX420 FA IRS 09-19	0430-0312	0430-0312	-	-
TRX450ES 98-01	0430-0312	0430-0312	-	-
TRX450FE 02-04	0430-0312	0430-0312	-	-
TRX450FM 02-04	0430-0312	0430-0312	-	-
TRX450S 98-01	0430-0312	0430-0312	-	-
TRX500FA 01-14	0430-0312	0430-0219	-	-
TRX500FA 15-19	0430-0312	0430-0312	-	-
TRX500FE 05-13	0430-0312	0430-0219	-	-
TRX500FE 14-19	0430-0312	0430-0312	-	-
TRX500FGA 04-08	0430-0312	0430-0219	-	-
TRX500FM 05-13	0430-0312	0430-0219	-	-
TRX500FM IRS 15-19	0430-0312	0430-0312	-	-
TRX500FM SOLID AXLE 14-19	0430-0312	0430-0312	-	-
TRX500FPA 09-14	0430-0312	0430-0219	-	-
TRX500FPE 07-13	0430-0312	0430-0219	-	-

SUSPENSION & DRIVE

FITS MODEL	LOWER BEARING PART #	UPPER BEARING PART #	LOWER BUSHING PART #	UPPER BUSHING PART #
FRONT A-ARM BEARING AND SEAL KITS (CONT)				
HONDA (CONT)				
TRX500FPM 08-13	0430-0312	0430-0219	-	-
TRX500TM 05-06	0430-0312	0430-0219	-	-
TRX650 RINCON 03-05	0430-0312	0430-0223	-	-
TRX680 RINCON 06-14	0430-0312	0430-0223	-	-
TRX680 RINCON 15-19	0430-0312	0430-0219	-	-
JOHN DEERE				
TRAIL BUCK 650 ALL	0430-0813	0430-0813	0430-0665	0430-0665
KAWASAKI				
KLF300B BAYOU 1988-05	0430-0458	0430-0458	-	-
KLF300C BAYOU 4X4 1989-05	0430-0458	0430-0458	-	-
KVF300A PRAIRIE 4X4 99-02	0430-0458	-	-	-
KVF300B PRAIRIE 2X4 99-02	0430-0458	-	-	-
KVF360A PRAIRIE 4X4 03-13	0430-0458	-	-	-
KVF360B PRAIRIE 03-11	0430-0458	-	-	-
KVF360C PRAIRIE 4X4 03-13	0430-0458	-	-	-
KLF400 BAYOU 93-99	0430-0458	0430-0458	-	-
KVF400A PRAIRIE 4X4 97-98	0430-0458	-	-	-
KVF400B PRAIRIE 98	0430-0458	-	-	-
KVF400C PRAIRIE 4X4 99-02	0430-0458	-	-	-
KVF400D PRAIRIE 99-02	0430-0458	-	-	-
MULE 2500 94-00	0430-0458	-	-	-
MULE 2510 4X4 93-00	0430-0458	-	-	-
MULE 2520 93-00	0430-0458	-	-	-
MULE 3000 01-08	0430-0458	-	-	-
MULE 3010 4X4 01-08	0430-0458	-	-	-
MULE 3020 01-03	0430-0458	-	-	-
MULE 4000 09-19	0430-0458	-	-	-
MULE 4010 4X4 09-19	0430-0458	-	-	-
KVF650 BRUTE FORCE 05-13	0430-0221	-	-	-
KVF650 I BRUTE FORCE 06-13	0430-0220	0430-0222	-	-
KVF650 PRAIRIE 02-03	0430-0221	-	-	-
KFX 700 V-FORCE 04-09	0430-0220	0430-0220	-	-
KVF700 PRAIRIE 04-06	0430-0221	-	-	-
KVF750 BRUTE FORCE 05-11	0430-0220	0430-0222	-	-
KVF750 BRUTE FORCE 12-19	0430-0732	0430-0731	-	-
KVF750 BRUTE FORCE EPS 12-19	0430-0732	0430-0731	-	-
MULE 2510 DIESEL 00-02	0430-0458	-	-	-
MULE 3010 DIESEL 01-08	0430-0458	-	-	-
MULE 4010 4X4 DIESEL 09-13	0430-0458	-	-	-
POLARIS				
LSV ELECTRIC 4X4 11-12	0430-0818	-	0430-0632	-
RANGER EV 4X4 10-13	0430-0818	-	0430-0632	-
RANGER EV 4X4 14-19	0430-0806	-	0430-0846	-
BIG BOSS 250 4X6 1992	-	-	0430-0628	-
BIG BOSS 250 6X6 1992	-	-	0430-0628	-
BIG BOSS 250 6X6 93	-	-	0430-0627	-
TRAIL BLAZER 250 1990-1992	-	-	0430-0628	-
TRAIL BLAZER 250 93-95	-	-	0430-0627	-
TRAIL BLAZER 250 96-02	0430-0807	-	0430-0627	-
TRAIL BLAZER 250 03-06	0430-0807	-	0430-0628	-
TRAIL BOSS 250 1988	-	-	0430-0628	-
TRAIL BOSS 250 2X4 1987-1992	-	-	0430-0628	-
TRAIL BOSS 250 2X4 93-99	-	-	0430-0627	-
TRAIL BOSS 250 4X4 1989-1992	-	-	0430-0628	-
TRAIL BOSS 250 4X4 93-95	0430-0807	-	0430-0627	-
TRAIL BOSS 250 R/ES 1988	-	-	0430-0628	-
XPLORER 250 4X4 00-02	0430-0807	-	0430-0627	-
300 2X4 94-95	-	-	0430-0627	-
300 4X4 94-95	0430-0807	-	0430-0627	-
BIG BOSS 300 6X6 94	0430-0807	-	0430-0627	-
HAWKEYE 2X4 06-11	0430-0822	-	0430-0628	-
HAWKEYE 4X4 06	0430-0822	-	0430-0628	-
HAWKEYE 4X4 07	0430-0822	-	0430-0628	-
SPORTSMAN 300 4X4 08-10	0430-0822	-	0430-0628	-
XPLORER 300 4X4 96-99	0430-0807	-	0430-0627	-
XPRESS 300 96-99	0430-0807	-	0430-0627	-
ACE 325 14-15	0430-0807	-	0430-0628	-
ACE 325 16	0430-0943	-	0430-0628	-
MAGNUM 325 2X4 00-02	0430-0807	-	0430-0627	-
MAGNUM 325 4X4 00-02	0430-0807	-	0430-0627	-
MAGNUM 325 4X4 HDS 02	0430-0807	-	0430-0627	-
MAGNUM 325 4X4 HDS AA 01	0430-0807	-	0430-0627	-
MAGNUM 325 4X4 HDS FB 01	0430-0807	-	0430-0627	-
RANGER 325 ETX 15	0430-0806	-	0430-0632	-

FITS MODEL	LOWER BEARING PART #	UPPER BEARING PART #	LOWER BUSHING PART #	UPPER BUSHING PART #
FRONT A-ARM BEARING AND SEAL KITS (CONT)				
POLARIS (CONT)				
RANGER 325 ETX 16	0430-0806	-	0430-0846	-
SPORTSMAN 325 ETX EFI 15	0430-0807	-	0430-0628	-
TRAIL BOSS 325 00-02	0430-0807	-	0430-0627	-
XPEDITION 325 00-02	0430-0807	-	0430-0627	-
ATP 330 4X4 04-05	0430-0807	-	0430-0628	-
MAGNUM 330 2X4 03-05	0430-0807	-	0430-0628	-
MAGNUM 330 4X4 05	0430-0807	-	0430-0628	-
MAGNUM 330 4X4 AA AB AC 03-04	0430-0807	-	0430-0628	-
MAGNUM 330 4X4 FB 03-04	0430-0807	-	0430-0628	-
TRAIL BLAZER 330 08-13	0430-0807	-	0430-0628	-
TRAIL BOSS 330 03-13	0430-0807	-	0430-0628	-
SPORTSMAN 335 99-00	0430-0807	-	0430-0627	-
WORKER 335 99	0430-0807	-	0430-0627	-
350L 2X4 93	0430-0807	-	0430-0627	-
350L 4X4 93	0430-0807	-	0430-0627	-
BIG BOSS 350L 6X6 93	0430-0807	-	0430-0627	-
SPORTSMAN 350 4X4 93	0430-0807	-	0430-0627	-
TRAIL BOSS 350L 4X4 90-92	-	-	0430-0628	-
400L 2X4 94-95	0430-0807	-	0430-0627	-
400L 4X4 94	0430-0807	-	0430-0627	-
BIG BOSS 400L 6X6 94-97	0430-0807	-	0430-0627	-
HAWKEYE 400 HO 2X4 11-13	0430-0807	-	0430-0628	-
MAGNUM 400L 6X6 96-97	0430-0807	-	0430-0627	-
RANGER 4X4 400 10-14	0430-0818	-	0430-0632	-
SPORTSMAN 400 4X4 94-97	0430-0807	-	0430-0627	-
SPORTSMAN 400 4X4 02	0430-0807	-	0430-0627	-
SPORTSMAN 400 4X4 03-05	0430-0807	-	0430-0628	-
SPORTSMAN 400 4X4 AA AE AG 04	0430-0807	-	0430-0628	-
SPORTSMAN 400 4X4 AQ-AV 04	0430-0807	-	0430-0628	-
SPORTSMAN 400 HO 4X4 09-10	0430-0822	-	0430-0628	-
SPORTSMAN 400 HO 4X4 11-14	0430-0807	-	0430-0628	-
TRAIL BLAZER 400 03	0430-0807	-	0430-0628	-
XPLORER 400L 4X4 95-02	0430-0807	-	0430-0627	-
XPRESS 400L 2X4 96-97	0430-0807	-	0430-0627	-
MAGNUM 425 2X4 95-98	0430-0807	-	0430-0627	-
MAGNUM 425 4X4 95-98	0430-0807	-	0430-0627	-
XPEDITION 425 00-02	0430-0807	-	0430-0627	-
SPORTSMAN 450 06	0430-0807	-	0430-0628	-
SPORTSMAN 450 HO 16	0430-0943	-	0430-0628	-
SPORTSMAN 450 HO 17-19	0430-0943	-	0430-0628	-
SPORTSMAN 450 HO 2X4 MD 16	0430-0943	-	0430-0628	-
DIESEL 455 4X4 00-01	0430-0807	-	0430-0627	-
ACE 500 17-19	0430-0943	-	0430-0628	-
ATP 500 4X4 04-05	0430-0807	-	0430-0628	-
BIG BOSS 500 6X6 98-03	0430-0807	-	0430-0628	-
MAGNUM 500 2X4 HDS 02	0430-0807	-	0430-0627	-
MAGNUM 500 4X4 00-01	0430-0807	-	0430-0627	-
MAGNUM 500 4X4 AA 02	0430-0807	-	0430-0627	-
MAGNUM 500 4X4 AB/FB 02	0430-0807	-	0430-0627	-
MAGNUM 500 4X4 HDS 03	0430-0807	-	0430-0628	-
MAGNUM 500 4X4 HDS AA 01-02	0430-0807	-	0430-0627	-
MAGNUM 500 4X4 HDS FB 01	0430-0807	-	0430-0627	-
RANGER 2X4 500 05-09	0430-0818	-	0430-0632	-
RANGER 4X4 500 99	0430-0807	-	0430-0628	-
RANGER 4X4 500 02	-	-	0430-0627	-
RANGER 4X4 500 05	0430-0818	-	0430-0632	-
RANGER 4X4 500 06	0430-0818	-	0430-0632	-
RANGER 4X4 500 CREW 11-13	0430-0818	-	0430-0632	-
RANGER 4X4 500 EFI 06-08	0430-0818	-	0430-0632	-
RANGER 4X4 500 EFI 09-10	0430-0818	0430-0818	0430-0632	0430-0632
RANGER 4X4 500 EFI 11-13	0430-0818	-	0430-0632	-
RANGER 500 2WD 17-19	0430-0806	-	0430-0846	-
RANGER 500 4X4 19	0430-0806	-	0430-0846	-
RANGER 500 ETX 17	0430-0806	-	0430-0846	-
RANGER 6X6 500 99	0430-0807	-	0430-0627	-
RANGER 6X6 500 02	-	-	0430-0627	-
RANGER 6X6 500 05	-	-	0430-0632	-
SPORTSMAN 500 4X4 96-02	0430-0807	-	0430-0627	-
SPORTSMAN 500 4X4 HO 03-13	0430-0807	-	0430-0628	-
SPORTSMAN 500 4X4 HO	-	-	-	-
AA-AC-AE-AG 04	0430-0807	-	0430-0628	-
SPORTSMAN 500 6X6 00-02	0430-0807	-	0430-0627	-
SPORTSMAN 500 6X6 03-08	0430-0807	-	0430-0628	-
SPORTSMAN 500 EFI 06-09	0430-0807	-	0430-0628	-

FITS MODEL	LOWER BEARING PART #	UPPER BEARING PART #	LOWER BUSHING PART #	UPPER BUSHING PART #
FRONT A-ARM BEARING AND SEAL KITS (CON'T)				
POLARIS (CON'T)				
SPORTSMAN 500 X2 06	0430-0806	-	0430-0846	-
SPORTSMAN 500 X2 07	0430-0808	-	0430-0666	-
SPORTSMAN 500 X2 08-09	0430-0808	-	0430-0666	-
SPORTSMAN TOURING 500 08-13	0430-0808	-	0430-0666	-
WORKER 500 4X4 00-02	0430-0807	-	0430-0627	-
XPLORER 500 97	0430-0807	-	0430-0627	-
SPORTSMAN 550 11	0430-0817	0430-0817	0430-0629	0430-0629
SPORTSMAN 550 12-13	0430-0817	0430-0817	0430-0629	0430-0629
SPORTSMAN 550 EPS 10	0430-0819	0430-0819	0430-0666	0430-0666
SPORTSMAN 550 EPS 11	0430-0817	0430-0817	0430-0629	0430-0629
SPORTSMAN 550 EPS 12-13	0430-0817	0430-0817	0430-0629	0430-0629
SPORTSMAN 550 EPS 14	0430-0820	0430-0820	0430-0846	0430-0846
SPORTSMAN 550 X2 10	0430-0819	0430-0819	0430-0666	0430-0666
SPORTSMAN 550 X2 11	0430-0817	0430-0817	0430-0629	0430-0629
SPORTSMAN 550 X2 12-13	0430-0817	0430-0817	0430-0629	0430-0629
SPORTSMAN 550 X2 14	0430-0820	0430-0820	0430-0846	0430-0846
SPORTSMAN 550 X2 EPS LE 14	0430-0820	0430-0820	0430-0846	0430-0846
SPORTSMAN 550 XP 10	0430-0819	0430-0817	0430-0629	0430-0629
SPORTSMAN 550 XP 13	0430-0820	0430-0817	0430-0846	0430-0629
SPORTSMAN 550 XP 14	0430-0820	0430-0820	0430-0846	0430-0846
SPORTSMAN TOURING 550 EPS 10	0430-0819	0430-0819	0430-0666	0430-0666
SPORTSMAN TOURING 550 EPS 11-12	0430-0817	0430-0817	0430-0629	0430-0629
SPORTSMAN TOURING 550 EPS 13	0430-0817	0430-0817	0430-0629	0430-0629
SPORTSMAN TOURING 550 EPS 14	0430-0820	0430-0820	0430-0846	0430-0629
ACE 570 15	0430-0807	-	0430-0628	-
ACE 570 16-17	0430-0943	-	0430-0628	-
ACE 570 18-19	0430-1012	-	-	-
RANGER 570 14-19	0430-0806	-	0430-0846	-
RANGER 570 CREW 14-19	0430-0806	-	0430-0846	-
RANGER 570 CREW EPS 14-19	0430-0806	-	0430-0846	-
RANGER 570 EPS 14-19	0430-0806	-	0430-0846	-
RANGER 570 FULL SIZE 15-16	0430-0806	0430-0821	0430-0846	0430-0847
RANGER 570 FULL SIZE 17-19	0430-0806	-	0430-0846	-
RANGER 570 FULL SIZE CREW 15	0430-0806	0430-0821	0430-0846	0430-0847
RANGER 570 FULL SIZE CREW 16	0430-0806	-	0430-0846	-
RANGER 570 FULL SIZE WITH STRUT 16	0430-0806	-	0430-0846	-
RANGER 570 HD 19	0430-0806	-	0430-0846	-
RANGER 570 XP 16	0430-0806	-	0430-0846	-
RANGER 570-6 FULL SIZE CREW 16-19	0430-0806	-	0430-0846	-
RZR 570 EFI 12-13	0430-0822	0430-0822	0430-0628	0430-0628
RZR 570 EFI 14-19	0430-0822	0430-0822	0430-0628	0430-0628
RZR 570 EFI EPS 19	0430-0822	0430-0822	0430-0628	0430-0628
RZR 570 EPS 18	0430-0822	0430-0822	0430-0628	0430-0628
RZR 570 S 17	0430-0822	0430-0822	0430-0628	0430-0628
SPORTSMAN 570 6X6 17-19	0430-0943	-	0430-0628	-
SPORTSMAN 570 EFI 14-15	0430-0807	-	0430-0628	-
SPORTSMAN 570 EFI 16-19	0430-0943	-	0430-0628	-
SPORTSMAN 570 EFI EPS 14-15	0430-0807	-	0430-0628	-
SPORTSMAN 570 EFI X2 EPS 15	0430-0807	-	0430-0628	-
SPORTSMAN 570 EFI X2 EPS 16-19	0430-0943	-	0430-0628	-
SPORTSMAN 570 SP 15	-	0430-0820	0430-0628	0430-0846
SPORTSMAN 570 SP 16-19	0430-0943	0430-0820	0430-0628	0430-0846
SPORTSMAN 570 SP AFTER 12/15/17 18	0430-0943	0430-0820	0430-0628	0430-0846
SPORTSMAN 570 SP BEFORE 12/15/17 18	0430-0943	0430-0820	0430-0628	0430-0846
SPORTSMAN 570 SP EPS QUAD 15	-	0430-0820	0430-0628	0430-0846
SPORTSMAN 570 SP EPS QUAD 16	-	0430-0820	-	0430-0846
SPORTSMAN 570 SP MD 15	-	0430-0820	0430-0628	0430-0846
SPORTSMAN 570 SP MD 16	-	0430-0820	-	0430-0846
SPORTSMAN TOURING 570 EFI 14	0430-0807	-	0430-0628	-
SPORTSMAN TOURING 570 EFI 16-19	0430-0943	-	0430-0628	-
SPORTSMAN TOURING 570 EFI EPS 15	0430-0807	-	0430-0628	-
SPORTSMAN TOURING 570 EFI EPS 16	0430-0943	-	0430-0628	-
SPORTSMAN TOURING 570 SP 15	-	0430-0820	0430-0628	0430-0846
SPORTSMAN TOURING 570 SP 16-19	0430-0943	0430-0820	0430-0628	0430-0846
SPORTSMAN 600 4X4 03-05	0430-0807	-	0430-0628	-
RANGER 4X4 700 05-08	0430-0818	-	0430-0632	-
RANGER 4X4 700 09	0430-0818	0430-0818	0430-0632	0430-0632
RANGER 4X4 700 CREW 08-09	0430-0818	-	0430-0632	-
RANGER 6X6 700 EFI 06-07	0430-0818	-	0430-0632	-
RANGER 6X6 700 EFI 08-09	0430-0818	-	0430-0632	-
SPORTSMAN 700 4X4 02-07	0430-0807	-	0430-0628	-
SPORTSMAN 700 EFI 05-07	0430-0807	-	0430-0628	-
SPORTSMAN MV7 05	0430-0807	-	0430-0628	-
SPORTSMAN X2 700 EFI 08	0430-0808	-	0430-0666	-

FITS MODEL	LOWER BEARING PART #	UPPER BEARING PART #	LOWER BUSHING PART #	UPPER BUSHING PART #
FRONT A-ARM BEARING AND SEAL KITS (CON'T)				
POLARIS (CON'T)				
RANGER 4X4 800 EFI 10-14	0430-0818	0430-0818	0430-0632	0430-0632
RANGER 4X4 800 EFI CREW 10-14	0430-0818	0430-0818	0430-0632	0430-0632
RANGER 4X4 800 EFI MIDSIZE 13	0430-0818	0430-0818	0430-0632	0430-0632
RANGER 4X4 800 EFI MIDSIZE 14	0430-0806	-	0430-0846	-
RANGER 6X6 800 10-16	0430-0818	0430-0818	0430-0632	0430-0632
RANGER XP 800 12	0430-0818	0430-0818	0430-0632	0430-0632
RZR 4 800 10-13	0430-0822	0430-0822	0430-0628	0430-0628
RZR 4 800 14	0430-0822	0430-0822	0430-0628	0430-0628
RZR 800 08-12	0430-0822	0430-0822	0430-0628	0430-0628
RZR 800 13	0430-0822	0430-0822	0430-0628	0430-0628
RZR 800 14	0430-0822	0430-0822	0430-0628	0430-0628
RZR S 800 09-13	0430-0822	0430-0822	0430-0628	0430-0628
RZR S 800 14	0430-0822	0430-0822	0430-0628	0430-0628
SPORTSMAN 800 EFI 05-10	0430-0807	-	0430-0628	-
SPORTSMAN 800 EFI 11-14	0430-0807	-	0430-0628	-
SPORTSMAN 800 EFI 6X6 09-14	0430-0807	-	0430-0628	-
SPORTSMAN 800 HO EFI 09	0430-0807	-	0430-0628	-
SPORTSMAN TOURING 800 EFI 08-09	0430-0808	-	0430-0666	-
SPORTSMAN X2 800 EFI 07	0430-0808	-	0430-0666	-
SPORTSMAN X2 800 EFI 08-09	0430-0808	-	0430-0666	-
SPORTSMAN 850 HIGH LIFTER 17-19	0430-0820	0430-0820	0430-0846	0430-0846
SPORTSMAN 850 SP 15-18	0430-0820	0430-0820	0430-0846	0430-0846
SPORTSMAN 850 WV 14	0430-0820	0430-0820	0430-0846	0430-0846
SPORTSMAN 850 XP HO EPS MD 15	0430-0820	0430-0820	0430-0846	0430-0846
SPORTSMAN TOURING 850 19	0430-0820	0430-0820	0430-0846	0430-0846
SPORTSMAN TOURING 850 EPS 14	0430-0820	0430-0820	0430-0846	0430-0846
SPORTSMAN TOURING 850 SP 15-18	0430-0820	0430-0820	0430-0846	0430-0846
SPORTSMAN TOURING 850 SP MD 15	0430-0820	0430-0820	0430-0846	0430-0846
SPORTSMAN TOURING EPS 850 10	0430-0819	0430-0819	0430-0666	0430-0666
SPORTSMAN TOURING EPS 850 11	0430-0817	0430-0817	0430-0629	0430-0629
SPORTSMAN TOURING EPS 850 12-13	0430-0817	0430-0817	0430-0629	0430-0629
SPORTSMAN TOURING EPS 850 HO 13	0430-0817	0430-0817	0430-0629	0430-0629
SPORTSMAN X2 850 11	0430-0817	0430-0817	0430-0629	0430-0629
SPORTSMAN XP 850 09	0430-0817	0430-0817	0430-0629	0430-0629
SPORTSMAN XP 850 10	0430-0819	0430-0819	0430-0666	0430-0666
SPORTSMAN XP 850 11	0430-0817	0430-0817	0430-0629	0430-0629
SPORTSMAN XP 850 12-13	0430-0817	0430-0817	0430-0629	0430-0629
SPORTSMAN XP 850 EPS 09	0430-0817	0430-0817	0430-0629	0430-0629
SPORTSMAN XP 850 EPS 10	0430-0819	0430-0819	0430-0666	0430-0666
SPORTSMAN XP 850 EPS 11	0430-0817	0430-0817	0430-0629	0430-0629
SPORTSMAN XP 850 EPS 12-14	0430-0817	0430-0817	0430-0629	0430-0629
ACE 900 EFI EPS 16	0430-0943	-	0430-0628	-
ACE 900 EPS XC 17-19	0430-1012	-	-	-
BRUTUS HD 900 13	0430-0808	0430-0823	0430-0666	-
BRUTUS HD 900 14-15	0430-0806	0430-0821	0430-0846	0430-0847
RANGER 4X4 900 DIESEL 11-14	0430-0818	0430-0818	0430-0632	0430-0632
RANGER 4X4 900 DIESEL CREW 12-14	0430-0818	0430-0818	0430-0632	0430-0632
RANGER 900 CREW 14-19	0430-0806	0430-0821	0430-0846	0430-0847
RANGER 900 CREW EPS 14-19	0430-0806	0430-0821	0430-0846	0430-0847
RANGER 900 XP 13	0430-0808	0430-0823	0430-0666	0430-0666
RANGER 900 XP 14	0430-0808	0430-0821	0430-0666	0430-0847
RANGER 900 XP 15-19	0430-0806	0430-0821	0430-0846	0430-0847
RANGER 900 XP EPS 19	0430-0806	0430-0821	0430-0846	0430-0847
RANGER 900D HIPPO MPS 14	0430-0818	0430-0818	0430-0632	0430-0632
RANGER DIESEL HST/DELUXE 14	0430-0806	0430-0821	0430-0846	0430-0847
RZR 4 900 15	0430-0806	0430-0824	0430-0846	0430-0848
RZR 4 900 16	0430-0806	0430-0824	0430-0846	0430-0848
RZR 4 900 17-18	0430-1012	0430-1013	-	-
RZR 4 XP 900 12-13	0430-0808	0430-0822	0430-0666	0430-0628
RZR 4 XP 900 14	0430-0806	0430-0822	0430-0846	0430-0628
RZR 900 50 55 INCH 15-16	0430-0806	0430-0824	0430-0846	0430-0848
RZR 900 50 55 INCH 17	0430-1012	0430-1013	-	-
RZR 900 50 INCH 18-19	0430-1012	0430-1013	-	-
RZR 900 60 INCH 16	0430-0806	0430-0824	0430-0846	0430-0848
RZR 900 60 INCH 17-19	0430-1012	0430-1013	-	-
RZR XP 900 11-13	0430-0808	0430-0822	0430-0666	0430-0628
RZR XP 900 14	0430-0806	0430-0821	0430-0846	0430-0847
GENERAL 1000 EPS 16	0430-1012	-	-	-
GENERAL 1000 EPS 17-19	0430-1012	0430-1013	-	-
RANGER 1000 DIESEL 15	-	0430-0821	0430-0846	0430-0847
RANGER 1000 DIESEL 16-18	0430-0806	0430-0821	0430-0846	0430-0847
RANGER 1000 DIESEL CREW 15-18	0430-0806	0430-0821	0430-0846	0430-0847
RANGER 1000 EPS BASE 18-19	0430-1012	0430-1012	-	-
RANGER HST 15-16	0430-0806	0430-0821	0430-0846	0430-0847

SUSPENSION & DRIVE

FITS MODEL	LOWER BEARING PART #	UPPER BEARING PART #	LOWER BUSHING PART #	UPPER BUSHING PART #
FRONT A-ARM BEARING AND SEAL KITS (CON'T)				
POLARIS (CON'T)				
RANGER XP 1000 EPS CREW 19	0430-1012	0430-1012	-	-
RANGER XP 1000 EPS CREW MUD 19	0430-1012	0430-1012	-	-
RANGER XP 1000 EPS CREW NSTR 19	0430-1012	0430-1012	-	-
RZR 1000 60 INCH 16	0430-0806	0430-0824	0430-0846	0430-0848
RZR 1000 60 INCH 17	0430-1012	0430-1013	0430-0846	0430-0848
RZR 1000 60 INCH 18-19	0430-1012	0430-1013	-	0430-0848
RZR RSI 18-19	0430-1042	0430-1043	-	-
RZR S4 1000 19	0430-1012	0430-1013	-	-
RZR XP 1000 14-15	0430-0806	0430-0824	0430-0846	0430-0848
RZR XP 1000 17-19	0430-1012	0430-1013	-	-
RZR XP 4 1000 14-15	0430-0806	0430-0824	0430-0846	0430-0848
RZR XP 4 1000 17-19	0430-1012	0430-1013	-	-
RZR XP 4 TURBO 16	0430-0806	0430-0824	0430-0846	0430-0848
RZR XP 4 TURBO 17-19	0430-1012	0430-1013	-	-
RZR XP TURBO 16	0430-0806	0430-0824	0430-0846	0430-0848
RZR XP TURBO 17-19	0430-1012	0430-1013	-	-
RZR XP TURBO MD 16	0430-0806	0430-0824	0430-0846	0430-0848
SPORTSMAN 1000 HIGH LIFTER 16-19	0430-0820	0430-0820	0430-0846	0430-0846
SPORTSMAN 1000 MD 15	0430-0820	0430-0820	0430-0846	0430-0846
SPORTSMAN 1000 XP 15-18	0430-0820	0430-0820	0430-0846	0430-0846
SPORTSMAN TOURING 1000 15-19	0430-0820	0430-0820	0430-0846	0430-0846
SUZUKI				
LT-230E 1988-93	0430-0041	0430-0041	-	-
LT-250S 1989-1990	0430-0042	0430-0042	-	-
LT-4WD 250 QUAD RUNNER 1987-98	0430-0313	0430-0313	-	-
LT-F250 2WD 1988-01	0430-0313	0430-0313	-	-
LT-F250 OZARK 02-14	0430-0313	0430-0313	-	-
LT-F250F 4WD QUAD RUNNER 99-02	0430-0313	0430-0313	-	-
LT-F300F KING QUAD 99-02	0430-0313	0430-0313	-	-
LT-F4WDX KING QUAD 300 1991-98	0430-0313	0430-0313	-	-
LT-A400 2WD KING QUAD 08-09	0430-0313	0430-0313	-	-
LT-A400 EIGER 2WD 02-07	0430-0313	0430-0313	-	-
LT-A400F 4WD KING QUAD 08-18	0430-0313	0430-0313	-	-
LT-A400F EIGER 4WD 02-07	0430-0313	0430-0313	-	-
LT-F400 2WD KING QUAD 08-09	0430-0313	0430-0313	-	-
LT-F400 EIGER 2WD 02-07	0430-0313	0430-0313	-	-
LT-F400F 4WD KING QUAD 08-18	0430-0313	0430-0313	-	-
LT-F400F EIGER 4WD 02-07	0430-0313	0430-0313	-	-
LTA-450 X KING QUAD 07	0430-0313	0430-0534	-	-
LTA-450 X KING QUAD 08-10	0430-0313	0430-0667	-	-
LT-A500F QUAD MASTER AUTO 00-01	0430-0313	0430-0313	-	-
LT-A500F VINSON 02-07	0430-0313	0430-0313	-	-
LT-A500X 09-18	0430-0313	0430-0667	-	-
LT-A500XP POWER STEERING 11-18	0430-0313	0430-0667	-	-
LT-F500F 98-02	0430-0313	0430-0313	-	-
LT-F500F VINSON 03-07	0430-0313	0430-0313	-	-
LTA-700 X KING QUAD 05-07	0430-0313	0430-0534	-	-
LTV-700F TWIN PEAKS 04-06	0430-0221	-	-	-
LTA-750 X KING QUAD 08-18	0430-0313	0430-0667	-	-
LTA-750 XP KING QUAD				
POWER STEERING 11-18	0430-0313	0430-0667	-	-
TEXTRON				
700 TBX 18	0430-0810	0430-0809	0430-0630	0430-0631
ALTERRA 700 18	0430-0810	0430-0809	0430-0630	0430-0631
ALTERRA 700 VLX 18	0430-0810	0430-0809	0430-0630	0430-0631
ALTERRA 700 VLX EPS 18	0430-0810	0430-0809	0430-0630	0430-0631
ALTERRA 700 XT EPS 18	0430-0810	0430-0809	0430-0630	0430-0631
WILDCAT TRAIL/XT 18	0430-0942	0430-0945	-	-
WILDCAT X LTD EPS 18	0430-0811	0430-0811	-	-
YAMAHA				
YFA1 1989-04	0430-0079	-	-	-
YFM125 GRIZZLY 04-13	0430-0079	-	-	-
YFB250 TIMBERWOLF 1992-98	0430-0311	-	-	-
YFB250FW TIMBERWOLF 94-00	0430-0311	-	-	-
YFM250 BEARTRACKER 99-04	0430-0311	-	-	-
YFM250 BIG BEAR 07-09	0430-0311	-	-	-
YFM250 MOTO-4 1989-1991	0430-0072	-	-	-
YFM250B BRUIN 05-06	0430-0311	-	-	-
YFM350 GRIZZLY IRS 07-11	0430-0311	0430-0311	-	-
YFM350BA BRUIN 2WD 04-06	0430-0311	0430-0311	-	-
YFM350ER MOTO-4 1987-95	-	0430-0072	-	-
YFM350FA BRUIN 4WD 04-06	0430-0311	0430-0311	-	-
YFM350FEW GRIZZLY 4WD 07-14	0430-0311	0430-0311	-	-
YFM350FW BIG BEAR 87-99	0430-0311	0430-0311	-	-

FITS MODEL	LOWER BEARING PART #	UPPER BEARING PART #	LOWER BUSHING PART #	UPPER BUSHING PART #
FRONT A-ARM BEARING AND SEAL KITS (CON'T)				
YAMAHA (CON'T)				
YFM350GW GRIZZLY 2WD 07-11	0430-0311	0430-0311	-	-
YFM350U BIG BEAR 96-99	0430-0311	0430-0311	-	-
YFM35FX WOLVERINE 95-05	0430-0311	0430-0311	-	-
YFM35X WOLVERINE 06-09	0430-0311	0430-0311	-	-
YFM400 BIG BEAR 2WD 00-04	0430-0311	0430-0311	-	-
YFM400 BIG BEAR 4WD 00-06	0430-0311	0430-0311	-	-
YFM400 BIG BEAR IRS 07-12	0430-0311	0430-0311	-	-
YFM400 GRIZZLY IRS 07-08	0430-0311	0430-0311	-	-
YFM400 KODIAK 4WD 93-04	0430-0311	0430-0311	-	-
YFM400 KODIAK 4WD 05-06	0430-0311	0430-0311	-	-
450 RHINO 06-09	0430-0311	0430-0311	-	-
KODIAK 450 4WD 18-19	0430-0311	0430-0311	-	-
YFM450 GRIZZLY EPS 11-14	0430-0311	0430-0311	-	-
YFM450 GRIZZLY IRS 07-14	0430-0311	0430-0311	-	-
YFM450 KODIAK 03-06	0430-0311	0430-0311	-	-
YFM45FX WOLVERINE 450 4X4 06-10	0430-0311	0430-0311	-	-
YFM550 GRIZZLY 09-14	0430-0311	0430-0311	-	-
YFM550 GRIZZLY EPS 09-14	0430-0311	0430-0311	-	-
YFM600 GRIZZLY 98-01	0430-0311	-	-	-
660 RHINO 04-07	0430-0311	0430-0311	-	-
YFM660 GRIZZLY 02-08	0430-0311	0430-0311	-	-
700 RHINO FI 08-13	0430-0311	0430-0311	-	-
KODIAK 700 4WD 16-19	0430-0311	0430-0311	-	-
KODIAK 700 EPS 4WD 16-19	0430-0311	0430-0311	-	-
KODIAK 700 EPS 4WD SE 18-19	0430-0311	0430-0311	-	-
VIKING 700 14-19	0430-0311	0430-0311	-	-
VIKING 700 VI EPS 15-19	0430-0311	0430-0311	-	-
WOLVERINE 16-18	0430-0311	0430-0311	-	-
WOLVERINE EPS 17	0430-0311	0430-0311	-	-
WOLVERINE R-SPEC 16-18	0430-0311	0430-0311	-	-
YFM700 GRIZZLY 07-19	0430-0311	0430-0311	-	-
WOLVERINE X2 19	0430-0311	0430-0311	-	-
WOLVERINE X2 R-SPEC 19	0430-0311	0430-0311	-	-
WOLVERINE X4 18-19	0430-0311	0430-0311	-	-
WOLVERINE X4 SE 18-19	0430-0311	0430-0311	-	-
YXZ1000R EPS 16-19	0430-0944	0430-0944	-	-

SWAY BAR LINKAGE BUSHING KIT

Replacement bushings pins and washers for Can-Am sway bar linkages. Kit includes eight high performance polyurethane bushings four steel pins and eight washers. Repairs both sides.



FITS MODEL	PART #
SWAY BAR LINKAGE BUSHING KIT	
CAN-AM	
OUTLANDER DPS 450 EFI 16-17	0430-0987
OUTLANDER L 450, OUTLANDER L MAX EFI 15-16	0430-0987
OUTLANDER MAX DPS 450 EFI 16-17	0430-0987
OUTLANDER DPS 570 EFI 16-17	0430-0987
OUTLANDER L, LE 570 EFI 16	0430-0987
OUTLANDER MAX 570, DPS 570 EFI 16	0430-0987
OUTLANDER XMR 570 EFI 16-17	0430-0987
RENEGADE 570 EFI 16-17	0430-0987
OUTLANDER DPS 650, DPS 850 EFI 17	0430-0987
OUTLANDER MAX DPS 850 EFI 17	0430-0987
RENEGADE 850, 850 XXC 16-17	0430-0987
OUTLANDER DPS 1000, XMR DPS 1000 EFI 17	0430-0987
RENEGADE 1000, 1000 XMR, XXC 16-17	0430-0987

UPPER AND LOWER A-ARM UPGRADE KIT

OEM design incorporates small spherical bearings that carry the load of the entire front end. Kit contains acetel thermoplastic bushings and hardened ground pins for the entire front end of machine. Made in the USA.



FITS MODEL	PART #
UPPER AND LOWER A-ARM UPGRADE KIT	
KAWASAKI	
KVF650 BRUTE FORCE 4X4 06-13	0430-0608
KVF750 BRUTE FORCE 4X4 05-17	0430-0608

POLARIS ALUMINUM SPRAGUE CARRIER WITH CLIPS AND ROLLERS

Replaces the cheap stock plastic carrier. Incredibly strong 6061 billet aluminum. Works with the OEM rollers and armature plate. Includes the spring clips. Available for most 2004-newer Polaris ATV/UTV models.



FITS MODEL	PART #
POLARIS ALUMINUM SPRAGUE CARRIER WITH CLIPS AND ROLLERS	
POLARIS	
ACE 325 14-16	1205-0283
RANGER ETX 15-16	1205-0284
SPORTSMAN ETX 15	1205-0284
ATP 330 04-05	1205-0282
MAGNUM 330 04-06	1205-0282
SPORTSMAN 400 04-05	1205-0282
RANGER 400 10-14	1205-0283
SPORTSMAN 400 HO 11-14	1205-0283
SPORTSMAN 450 06	1205-0282
SPORTSMAN 450 07	1205-0283
SPORTSMAN 450 16-18	1205-0284
ATP 500 04-05	1205-0282
RANGER 500 04-08	1205-0282
SPORTSMAN 500 04-06	1205-0282
RANGER 500 09-13	1205-0283
SCRAMBLER 500 10-12	1205-0283
SPORTSMAN 500 07-13	1205-0283
SPORTSMAN 550 XP 09-14	1205-0283
ACE 570 15	1205-0283
RANGER 570 (FULLSIZE ONLY) 15	1205-0283
RZR 570 12-14	1205-0283
SPORTSMAN 570 14	1205-0283
ACE 570 17-18	1205-0284
RANGER 570 (2015 MODEL IS MIDSIZE ONLY) 15-18	1205-0284
RZR 570 15-16	1205-0284
SPORTSMAN 570 15-18	1205-0284
SPORTSMAN 600 03-05	1205-0282
RANGER 700 05-08	1205-0282
RANGER 700 CREW/GX6 09	1205-0282

FITS MODEL	PART #
POLARIS ALUMINUM SPRAGUE CARRIER WITH CLIPS AND ROLLERS (CON'T)	
POLARIS (CON'T)	
SPORTSMAN 700 02-06	1205-0282
RANGER 700 (XP MODEL ONLY) 09	1205-0283
SPORTSMAN 700 07	1205-0283
SPORTSMAN 800 05-06	1205-0282
RANGER 800 10-14	1205-0283
RZR 800 08-14	1205-0283
SPORTSMAN 800 07-14	1205-0283
SPORTSMAN 850 XP 09-14	1205-0283
SCRAMBLER 850 15-18	1205-0284
SPORTSMAN 850 15-18	1205-0284
RANGER 900 XP 13-16	1205-0283
RZR 900 (ALL EXCEPT 2015-16 RZR-4 900) 11-16	1205-0283
ACE 900 16	1205-0284
RANGER 900 XP 16-17	1205-0284
RZR-4 900 15-16	1205-0284
RZR-4 900 (4 PASSENGER ONLY) 17-18	1205-0323
GENERAL 1000 16	1205-0284
GENERAL 1000 17-18	1205-0323
RANGER 1000 DIESEL 15-18	1205-0284
RANGER 1000 XP 17	1205-0323
RZR 1000 (MODELS USING DIFFERENTIAL # 1333344) 15-16	1205-0284
RZR 1000 XP (ONLY MODELS WITH DIFFERENTIAL PART # 1333112) 14-16	1205-0323
RZR 1000 XP 17-19	1205-0323
RZR-4 1000 16-19	1205-0323
RZR TURBO 17-18	1205-0323
RZR-S 1000 (152 CM (60") MODEL ONLY) 17-18	1205-0323
SCRAMBLER 1000 15-18	1205-0284
SPORTSMAN 1000 15-18	1205-0284



SUSPENSION & DRIVE

UTV STEERING RACK TIE ROD ASSEMBLY KIT



Can save you hundreds of dollars versus the cost of a complete steering rack assembly. The inner rod assemblies have increased shaft diameters to improve strength. Each kit includes heavy-duty inner and outer rod ends with replacement boot, clamps and any required lock washers. Outer tie rod ends are also available individually.

- **Outer Tie Rod End** - contains one tie rod end. This end attaches to the steering knuckle (two required per vehicle).
- **Rack and Pinion End Kit (left)** - contains both tie rod end and shaft that connects to the steering rack as well as the outer tie rod end. Kit also contains a boot and required hardware for the left (driver) side.
- **Rack and Pinion End Kit (right)** - contains both tie rod end and shaft that connects to the steering rack as well as the outer tie rod end. Kit also contains a boot and required hardware for the right (passenger) side.

FITS MODEL	OUTER TIE ROD END (TWO REQUIRED PER VEHICLE)	RACK AND PINION END KIT (LEFT HAND SIDE)	RACK AND PINION END KIT (RIGHT HAND SIDE)	RACK REPL BOOT KIT (BOTH BOOTS)
UTV STEERING RACK TIE ROD ASSEMBLY KIT				
CAN-AM				
COMMANDER ELECTRIC 9KW 13-15	0430-0745	-	-	-
COMMANDER 800 DPS 14-19	0430-0745	0430-0800	0430-0803	0430-0750
COMMANDER 800 LTD 16	0430-0745	0430-0800	0430-0803	0430-0750
COMMANDER 800 STD 11	0430-0669	0430-0698	0430-0699	0430-0751
COMMANDER 800 STD 12	0430-0742	0430-0740	0430-0741	0430-0751
COMMANDER 800 STD 13	0430-0745	-	-	0430-0751
COMMANDER 800 STD 14-19	0430-0745	0430-0800	0430-0803	0430-0750
COMMANDER 800 XT 11	0430-0669	0430-0698	0430-0699	0430-0751
COMMANDER 800 XT 12	0430-0742	0430-0740	0430-0741	0430-0751
COMMANDER 800 XT 13	0430-0745	-	-	-
COMMANDER 800 XT 14-19	0430-0745	0430-0800	0430-0803	0430-0750
COMMANDER 800 XTP 16	0430-0745	0430-0800	0430-0803	0430-0750
COMMANDER MAX 800 DPS 16-19	0430-0745	0430-0800	0430-0803	0430-0750
MAVERICK X3 17-19	0430-0746	-	-	-
COMMANDER 1000 DPS 16-19	0430-0745	0430-0800	0430-0803	0430-0750
COMMANDER 1000 EARLY				
BUILD 14MM 13	0430-0745	0430-0743	0430-0744	0430-0751
COMMANDER 1000 LATE				
BUILD 16MM 13	0430-0745	0430-0800	0430-0803	0430-0751
COMMANDER 1000 LTD 13	0430-0745	-	-	-
COMMANDER 1000 LTD 14-19	0430-0745	0430-0800	0430-0803	0430-0750
COMMANDER 1000 STD 11	0430-0669	0430-0698	0430-0699	0430-0751
COMMANDER 1000 STD 12	0430-0742	0430-0740	0430-0741	0430-0751
COMMANDER 1000 STD 13	0430-0745	-	-	-
COMMANDER 1000 STD 14-19	0430-0745	0430-0800	0430-0803	0430-0750
COMMANDER 1000 XT 16-19	0430-0745	0430-0800	0430-0803	0430-0750
COMMANDER 1000 XT/DPS 13	0430-0745	-	-	-
COMMANDER 1000 XT/DPS 14-15	0430-0745	0430-0800	0430-0803	0430-0750
COMMANDER 1000 XT/LTD/DPS 11	0430-0669	0430-0698	0430-0699	0430-0751
COMMANDER 1000 XT/LTD/DPS 12	0430-0742	0430-0740	0430-0741	0430-0751
COMMANDER 1000 XTP 14-17	0430-0745	0430-0800	0430-0803	0430-0750
COMMANDER MAX 1000 DPS 18-19	0430-0745	0430-0800	0430-0803	0430-0750
COMMANDER MAX 1000 LTD 15-19	0430-0745	0430-0800	0430-0803	0430-0750
COMMANDER MAX 1000 STD 15-19	0430-0745	0430-0800	0430-0803	0430-0750
COMMANDER MAX 1000 XT 18-19	0430-0745	0430-0800	0430-0803	0430-0750
COMMANDER MAX 1000				
XT/DPS 15-17	0430-0745	0430-0800	0430-0803	0430-0750
COMMANDER MAX 1000				
XT/DPS/LTD 14	0430-0745	0430-0800	0430-0803	0430-0750
COMMANDER MAX 1000 XTP 15	0430-0745	0430-0800	0430-0803	0430-0750
MAVERICK 1000 STD 13-18	0430-0746	0430-0747	0430-0748	0430-0750
MAVERICK 1000 XXC 14-16	0430-0746	0430-0953	0430-0954	0430-0750
MAVERICK 1000 XXC 17	0430-0746	0430-0747	0430-0748	0430-0750
MAVERICK MAX 1000 STD 14	0430-0746	0430-0800	0430-0803	0430-0750
MAVERICK MAX 1000 STD 15-18	0430-0746	0430-0747	0430-0748	0430-0750
MAVERICK MAX 1000 TURBO 16-17	0430-0746	0430-0747	0430-0748	0430-0750
MAVERICK MAX 1000				
TURBO XDS 15-17	0430-0746	0430-0747	0430-0748	0430-0750
MAVERICK MAX 1000				
TURBO XRS 16-17	0430-0746	0430-0747	0430-0748	0430-0750
MAVERICK MAX 1000 XC/XXC 16	0430-0746	0430-0747	0430-0748	0430-0750
MAVERICK MAX 1000 XDS 14	0430-0746	0430-0800	0430-0803	0430-0750
MAVERICK MAX 1000 XDS 15-16	0430-0746	0430-0747	0430-0748	0430-0750
MAVERICK MAX 1000 XMR 17-18	0430-0746	0430-0747	0430-0748	0430-0750

FITS MODEL	OUTER TIE ROD END (TWO REQUIRED PER VEHICLE)	RACK AND PINION END KIT (LEFT HAND SIDE)	RACK AND PINION END KIT (RIGHT HAND SIDE)	RACK REPL BOOT KIT (BOTH BOOTS)
UTV STEERING RACK TIE ROD ASSEMBLY KIT (CON'T)				
CAN-AM (CON'T)				
MAVERICK MAX 1000 XRS 14	0430-0746	0430-0800	0430-0803	0430-0750
MAVERICK MAX 1000 XRS 15	0430-0746	0430-0747	0430-0748	0430-0750
HONDA				
PIONEER 500 15-19	0430-1018	-	-	-
KAWASAKI				
MULE 600 05-16	0430-0876	-	-	-
MULE 610 4X4 05-16	0430-0876	-	-	-
MULE SX 17-19	0430-0876	-	-	-
TERYX 4 4X4 12-13	0430-1016	-	-	-
TERYX 750 4X4 08-13	0430-0684	-	0430-0697	0430-0750
MULE PRO-FX 800 15-19	0430-1017	-	-	-
MULE PRO-FX 800 LE 19	0430-1017	-	-	-
MULE PRO-FXR 800 18-19	0430-1017	-	-	-
MULE PRO-FXT 800 15-19	0430-1017	-	-	-
TERYX 4 4X4 800 14-19	0430-1016	-	-	-
TERYX 4X4 800 14-19	0430-1016	-	-	-
POLARIS				
LSV ELECTRIC 4X4 11-12	0430-0455	0430-0694	0430-0695	0430-0751
RANGER EV 4X4 10-14	0430-0455	0430-0694	0430-0695	0430-0751
RANGER EV 4X4 15	0430-0773	-	-	0430-0751
ACE 325 14-16	0430-0455	-	-	-
ACE 325 EU 15	0430-0455	-	-	-
ACE 325 HD 15	0430-0455	-	-	-
RANGER 325 ETX 15	0430-0773	-	-	0430-0751
RANGER 325 ETX 16	0430-0773	-	-	-
RANGER 325 ETX EU 15	-	-	-	0430-0751
RANGER 4X4 400 10-14	0430-0455	0430-0694	0430-0695	0430-0751
ACE 500 17-19	0430-0773	-	-	-
RANGER 2X4 500 05-09	0430-0455	0430-0688	0430-0689	0430-0751
RANGER 4X4 500 99-04	0430-0455	-	-	-
RANGER 4X4 500 05-06	0430-0455	0430-0688	0430-0689	0430-0751
RANGER 4X4 500 CREW 11-13	0430-0455	0430-0694	0430-0695	0430-0751
RANGER 4X4 500 EFI 06-08	0430-0455	0430-0688	0430-0689	0430-0751
RANGER 4X4 500 EFI 09-10	0430-0455	0430-0690	0430-0691	0430-0751
RANGER 4X4 500 EFI 11-13	0430-0455	0430-0694	0430-0695	0430-0751
RANGER 6X6 500 02-04	0430-0455	-	-	-
RANGER 6X6 500 05	0430-0455	0430-0688	0430-0689	0430-0751
RANGER SERIES 10 4X4 & 6X6 07	0430-0455	-	-	-
RANGER SERIES 11 4X4 & 6X6 07	0430-0455	-	-	-
ACE 570 15-16	0430-0455	-	-	-
ACE 570 17-19	0430-0773	-	-	-
ACE 570 HD 15-16	0430-0455	-	-	-
ACE 570 HD 17-19	0430-0773	-	-	-
ACE 570 MD 16	0430-0455	-	-	-
RANGER 570 14	0430-0455	0430-0694	0430-0695	0430-0751
RANGER 570 15-16	0430-0773	-	-	-
RANGER 570 CREW 14	0430-0455	0430-0694	0430-0695	0430-0751
RANGER 570 CREW 15	0430-0773	-	-	-
RANGER 570 CREW EPS 14	0430-0455	0430-0694	0430-0695	0430-0751
RANGER 570 CREW EPS 15	0430-0773	-	-	-
RANGER 570 EPS 14	0430-0455	0430-0694	0430-0695	0430-0751
RANGER 570 EPS 15-16	0430-0773	-	-	-
RANGER 570 FULL SIZE 15-16	0430-0455	0430-0692	0430-0693	0430-0751
RANGER 570 FULL SIZE CREW 15	0430-0455	0430-0692	0430-0693	0430-0751
RANGER 570 FULL SIZE				
WITH STRUT 16	0430-0773	-	-	0430-0751
RANGER 570 INTL 14	0430-0455	0430-0694	0430-0695	0430-0751
RZR 570 EFI 12-18	0430-0455	0430-0686	0430-0687	0430-0751
RZR 570 EFI 19	0430-0773	-	-	0430-0751
RZR 570 EFI EPS 19	0430-0773	-	-	0430-0751
RZR 570 EPS 18	0430-0455	0430-0686	0430-0687	0430-0751
RZR 570 EU 15-18	0430-0455	0430-0686	0430-0687	0430-0751
RANGER 4X4 700 05-08	0430-0455	0430-0688	0430-0689	0430-0751
RANGER 4X4 700 09	0430-0455	0430-0690	0430-0691	0430-0751
RANGER 4X4 700 CREW 08-09	0430-0455	0430-0688	0430-0689	0430-0751
RANGER 6X6 700 EFI 06-09	0430-0455	0430-0688	0430-0689	0430-0751
RANGER TM 700 06	0430-0455	-	-	0430-0751
RANGER 4X4 800 EFI 10-14	0430-0455	0430-0690	0430-0691	0430-0751
RANGER 4X4 800 EFI CREW 10	0430-0455	-	-	0430-0751
RANGER 4X4 800 EFI CREW 11-14	0430-0455	0430-0690	0430-0691	0430-0751
RANGER 4X4 800 EFI MIDSIZE 13-14	0430-0455	0430-0694	0430-0695	0430-0751
RANGER 6X6 800 10	0430-0455	-	-	0430-0751
RANGER 6X6 800 11-16	0430-0455	0430-0690	0430-0691	0430-0751

FITS MODEL	OUTER TIE ROD END (TWO REQUIRED PER VEHICLE)	RACK AND PINION END KIT (LEFT HAND SIDE)	RACK AND PINION END KIT (RIGHT HAND SIDE)	RACK REPL BOOT END KIT (BOTH BOOTS)
UTV STEERING RACK TIE ROD ASSEMBLY KIT (CON'T)				
POLARIS (CON'T)				
RANGER XP 800 12	0430-0455	0430-0690	0430-0691	0430-0751
RZR 4 800 10-14	0430-0455	0430-0692	0430-0693	0430-0751
RZR 800 08-14	0430-0455	0430-0686	0430-0687	0430-0751
RZR S 800 09-14	0430-0455	0430-0692	0430-0693	0430-0751
ACE 900 EFI EPS 16	0430-0455	-	-	-
ACE 900 EPS XC 17	0430-0455	-	-	-
ACE 900 EPS XC 18-19	0430-0773	-	-	-
RANGER 4X4 900 DIESEL 11-14	0430-0455	0430-0690	0430-0691	0430-0751
RANGER 4X4 900 DIESEL CREW 12-14	0430-0455	0430-0690	0430-0691	0430-0751
RANGER 900 CREW 14-19	0430-0455	0430-0692	0430-0693	0430-0751
RANGER 900 CREW EPS 14-19	0430-0455	0430-0692	0430-0693	0430-0751
RANGER 900 XP 13-19	0430-0455	0430-0692	0430-0693	0430-0751
RANGER 900 XP EPS 19	0430-0455	0430-0692	0430-0693	0430-0751
RANGER 900 XP EU 15-16	0430-0455	0430-0692	0430-0693	0430-0751
RANGER 900D HIPPO MPS 14	0430-0455	0430-0690	0430-0691	0430-0751
RANGER DIESEL HST/DELUXE 14	0430-0455	0430-0692	0430-0693	0430-0751
RANGER DIESEL INTL 14	0430-0455	0430-0690	0430-0691	0430-0751
RZR 4 900 15-18	0430-0799	0430-0802	0430-0805	0430-0751
RZR 4 XP 900 12-14	0430-0455	0430-0702	0430-0703	0430-0751
RZR 4 XP JAGGED X 13	0430-0455	0430-0702	0430-0703	0430-0751
RZR 900 50 55 INCH 15-16	0430-0799	0430-0801	0430-0804	0430-0751
RZR 900 50 55 INCH 17	0430-0799	-	-	0430-0751
RZR 900 50 INCH 18-19	0430-0799	-	-	0430-0751
RZR 900 50 INCH EPS 18	0430-0799	-	-	0430-0751
RZR 900 50 INCH EPS 19	0430-0799	0430-0801	0430-0804	0430-0751
RZR 900 50 INCH MD 17	0430-0799	0430-0801	0430-0804	0430-0751
RZR 900 60 INCH 16	0430-0799	0430-0802	0430-0805	0430-0751
RZR 900 60 INCH 17-18	0430-0799	-	-	0430-0751
RZR 900 60 INCH 19	0430-0799	0430-0802	0430-0805	0430-0751
RZR XP 900 11-14	0430-0455	0430-0702	0430-0703	0430-0751
GENERAL 1000 EPS 16-18	0430-0799	0430-0802	0430-0805	0430-0751
GENERAL 1000 EPS 19	0430-0799	-	-	0430-0751
GENERAL 4 1000 EPS 17-18	0430-0799	0430-0802	0430-0805	0430-0751
GENERAL 4 1000 EPS 19	0430-0799	-	-	0430-0751
RANGER 1000 DIESEL 15-18	0430-0455	0430-0692	0430-0693	0430-0751
RANGER 1000 DIESEL CREW 15-18	0430-0455	0430-0692	0430-0693	0430-0751
RANGER 1000 DIESEL EU 15-16	0430-0455	0430-0692	0430-0693	0430-0751
RANGER HST 15-16	0430-0455	0430-0692	0430-0693	0430-0751
RZR 1000 60 INCH 16-19	0430-0799	0430-0802	0430-0805	0430-0751
RZR RS1 18-19	0430-0799	-	-	-
RZR S4 1000 19	0430-0799	0430-0802	0430-0805	0430-0751
RZR XP 1000 14	0430-0773	0430-0774	0430-0775	0430-0751
RZR XP 1000 15-18	0430-0873	0430-0874	0430-0875	0430-0751
RZR XP 1000 INTL 15	0430-0773	-	-	0430-0751
RZR XP 4 1000 14	0430-0773	0430-0774	0430-0775	0430-0751
RZR XP 4 1000 15-18	0430-0873	0430-0874	0430-0875	0430-0751
RZR XP 4 TURBO 16	0430-0873	0430-0874	0430-0875	0430-0751
RZR XP TURBO 16	0430-0873	0430-0874	0430-0875	0430-0751
YAMAHA				
450 RHINO 06-09	0430-0669	0430-0670	0430-0670	0430-0749
660 RHINO 04-07	0430-0669	0430-0670	0430-0670	0430-0749
700 RHINO FI 08-13	0430-0669	0430-0670	0430-0670	0430-0749
VIKING 700 14-19	0430-0669	-	-	0430-0749
VIKING 700 VI EPS 15-19	0430-0669	-	-	0430-0749
WOLVERINE 16-18	0430-0669	-	-	0430-0749
WOLVERINE EPS 17	0430-0669	-	-	0430-0749
WOLVERINE R-SPEC EPS 16-18	0430-0669	-	-	0430-0749
WOLVERINE R-SPEC EPS SE 16-17	0430-0669	-	-	0430-0749
WOLVERINE R-SPEC HUNTER 18	0430-0669	-	-	0430-0749
WOLVERINE X2 19	0430-0669	-	-	0430-0749
WOLVERINE X4 18-19	0430-0669	-	-	0430-0749
WOLVERINE X4 SE 18-19	0430-0669	-	-	0430-0749
YZX1000R EPS 16-19	0430-0951	0430-0952	0430-0952	0430-0749



STEERING RACK KIT

Replaces an OEM rack at a fraction of the price of OEM. Includes rack assembly, inner tie rod ends and tie rods. Compatible with OEM and Moose Utility Division® Tie Rods, Boots and Tie Rod Ends. Does not include outer ends (available separately).

FITS MODEL	PART #
STEERING RACK KIT	
CAN-AM	
COMMANDER 800 (ALL) 11-14	0430-1071
COMMANDER 1000 (ALL) 11-14	0430-1071
MAVERICK MAX 1000 (ALL) 14	0430-1071
KAWASAKI	
MULE 600 09-16	0430-1080
MULE 610 4X4 10-16	0430-1080
MULE SX 17-19	0430-1080
MULE 4000 09-19	0430-1081
MULE 4010 4X4 09-19	0430-1081
POLARIS	
LSV ELECTRIC 4X4 11-12	0430-1074
RANGER EV 4X4 10-14	0430-1074
RANGER EV 4X4 15	0430-1074
RANGER EV MIDSIZE INTL 14	0430-1074
RANGER 4X4 400 10-14	0430-1074
RANGER 4X4 500 05-06	0430-1075
RANGER 4X4 500 CREW 11-13	0430-1074
RANGER 4X4 500 EFI 06-08	0430-1075
RANGER 4X4 500 EFI 09-10	0430-1082
RANGER 4X4 500 EFI 11-13	0430-1074
RANGER 6X6 500 05	0430-1075
RANGER 570 FULL SIZE 15	0430-1073
RANGER 4X4 700 05-08	0430-1075
RANGER 4X4 700 09	0430-1082
RANGER 4X4 700 CREW 08-09	0430-1075
RANGER 6X6 700 EFI 06-09	0430-1075
RANGER 4X4 800 EFI 10	0430-1082
RANGER 4X4 800 EFI 14	0430-1072
RANGER 4X4 800 EFI CREW 11-14	0430-1072
RANGER 4X4 800 EFI MIDSIZE 13	0430-1074
RANGER 6X6 800 11-16	0430-1072
RANGER XP 800 12	0430-1072
RZR 4 800 10-14	0430-1076
RZR 800 08-14	0430-1077
RZR S 800 09-14	0430-1076
BRUTUS HD 900 13-15	0430-1073
RANGER 4X4 900 DIESEL 11-14	0430-1072
RANGER 4X4 900 DIESEL CREW 12-13	0430-1072
RANGER 4X4 900 DIESEL CREW 14	0430-1073
RANGER 900 CREW 14-19	0430-1073
RANGER 900 XP 13-19	0430-1073
RANGER 900D HIPPO MPS 14	0430-1072
RANGER DIESEL HST/DELUXE 14	0430-1073
RANGER DIESEL INTL 14	0430-1072
RZR 4 XP 900 12-14	0430-1078
RZR XP 900 11-14	0430-1078
RANGER 1000 DIESEL 15-18	0430-1073
RANGER HST 15-16	0430-1073
YAMAHA	
450 RHINO 06-09	0430-1079
660 RHINO 04-07	0430-1079
700 RHINO FI 08-13	0430-1079

SUSPENSION & DRIVE



TIE ROD ASSEMBLY UPGRADE KITS

Heavy-duty 12mm style tie rod assemblies. Each kit contains two tie rods, four tie rod ends, cotter pins and jam nuts.

FITS MODEL	UPGRADE KIT PART #	REPL. TIE ROD ENDS PART #
TIE ROD ASSEMBLY UPGRADE KITS		
ARCTIC CAT		
250 4X4 99-05	0430-0566	0430-0719
300 2X4 98-04	0430-0566	0430-0719
300 2X4 10-16	0430-0315	0430-0227
300 4X4 98-05	0430-0566	0430-0719
350 CR 12	0430-0566	0430-0066
350 UTILITY 4X4 11	0430-0566	0430-0066
366 FIS W/AT 08-11	0430-0566	0430-0719
375 2X4 W/AT 02	0430-0566	0430-0719
375 4X4 W/AT 02	0430-0566	0430-0719
400 4X4 98-15	0430-0566	0430-0719
400 4X4 W/AT 03	0430-0566	0430-0719
400 4X4 W/AT 04	0430-0601	0430-0719
400 4X4 W/MT 01-04	0430-0566	0430-0719
400 FIS 2X4 W/AT&MT 03-04	0430-0601	0430-0719
400 FIS 4X4 TRV 06-14	0430-0601	0430-0719
400 FIS 4X4 W/AT 03-08	0430-0601	0430-0719
400 FIS 4X4 W/AT 13-14	0430-0566	0430-0719
400 FIS 4X4 W/MT 02-08	0430-0601	0430-0719
400 TBX 4X4 04-06	0430-0601	0430-0719
400 VP 4X4 W/AT&MT 05-06	0430-0566	0430-0719
ALTRRA 400 16-17	0430-0566	0430-0719
425 4X4 11-12	0430-0566	0430-0066
450 4X4 14-15	0430-0566	0430-0719
450 HI 10-11	0430-0601	0430-0719
450 TRV 12	0430-0601	0430-0719
450 XC 11-12	0430-0566	0430-0066
450 XC 14-17	0430-0566	0430-0719
450I EFI 12	0430-0601	0430-0719
450I TRV EFI 11-12	0430-0601	0430-0719
450I TRV GT EFI 12	0430-0601	0430-0719
ALTRRA 450 16	0430-0566	0430-0719
454 4X4 96-98	0430-0566	0430-0719
500 4X4 98-99	0430-0566	0430-0719
500 4X4 W/AT 00-02	0430-0566	0430-0719
500 EFI 4X4 W/AT 13-14	0430-0601	0430-0719
500 FIS 4X4 W/AT&MT 02-09	0430-0601	0430-0719
500 FIS TBX 4X4 02-06	0430-0601	0430-0719
500 FIS TRV 4X4 03-08	0430-0601	0430-0719
500 TRV 13-14	0430-0601	0430-0719
500 XT EFI 13-14	0430-0601	0430-0719
550 EFI 4X4 12-13	0430-0601	0430-0719
550 GT EFI 4X4 12	0430-0601	0430-0719
550 HI FIS 4X4 09-11	0430-0601	0430-0719
550 TRV 4X4 W/AT 09-13	0430-0601	0430-0719
550 XT EFI 4X4 13	0430-0601	0430-0719
550 XT LTD EFI 12-14	0430-0601	0430-0719
650 4X4 HI 05-11	0430-0601	0430-0719
650 4X4 W/AT V2 04-06	0430-0601	0430-0719
650 HI TBX 07-09	0430-0601	0430-0719
650I 4X4 12	0430-0601	0430-0719
700 AT EFI 06	0430-0601	0430-0719
700 DIESEL 07-14	0430-0601	0430-0719
700 EFI 07-08	0430-0601	0430-0719
700 EFI / LTD 11-14	0430-0601	0430-0719
700 EFI HI 08-11	0430-0601	0430-0719
700 GT EFI 12	0430-0601	0430-0719
700 LTD EFI 13	0430-0601	0430-0719
700 TBX 10-14	0430-0601	0430-0719
700 TRV 08-13	0430-0601	0430-0719

FITS MODEL	UPGRADE KIT PART #	REPL. TIE ROD ENDS PART #
TIE ROD ASSEMBLY UPGRADE KITS (CON'T)		
ARCTIC CAT (CON'T)		
700 XT 13-14	0430-0601	0430-0719
700I EFI MUDPRO / LTD 12-13	0430-0601	0430-0719
700I HI TRV GT EFI 11-12	0430-0601	0430-0719
1000 TRV 13	0430-0601	0430-0719
1000 TRV / CRUISER 09-12	0430-0601	0430-0719
1000 TRV GT 12	0430-0601	0430-0719
1000 XT 13	0430-0601	0430-0719
1000I GT 12	0430-0601	0430-0719
1000I LTD EFI MUDPRO 12-14	0430-0601	0430-0719
H2 MUDPRO 10-11	0430-0601	0430-0719
H2 THUNDERCAT 08-11	0430-0601	0430-0719
WILDCAT 1000 (ALL) 14-16	0430-0777	0430-0776
CAN-AM		
OUTLANDER 330 04-05	0430-0673	0430-0059
OUTLANDER 400 (ALL) 03-14	0430-0673	0430-0059
OUTLANDER MAX 400 EFI/STD/XT 15	0430-0673	0430-0059
OUTLANDER MAX 400 (ALL) 4X4 05-14	0430-0673	0430-0059
OUTLANDER DPS 450 EFI 16-19	0430-0674	0430-0717
OUTLANDER L 450 EFI 15-16	0430-0674	0430-0717
OUTLANDER MAX 450 EFI 16-19	0430-0674	0430-0717
OUTLANDER STD 450 EFI 17-19	0430-0674	0430-0717
OUTLANDER 500 STD 4X4 07-12	0430-0673	0430-0059
OUTLANDER 500 STD 4X4 13-15	0430-0674	0430-0717
OUTLANDER 500 XT 4X4 13-14	0430-0674	0430-0717
OUTLANDER L 500 EFI 15	0430-0674	0430-0717
OUTLANDER MAX 500 STD 4X4 07-12	0430-0673	0430-0059
OUTLANDER MAX 500 STD 4X4 13-15	0430-0674	0430-0717
QUEST 500 02-04	0430-0674	0430-0717
TRAXTER 500 99-05	0430-0674	0430-0717
OUTLANDER 570 EFI (ALL) 16-19	0430-0674	0430-0717
OUTLANDER 650 STD 4X4 06-12	0430-0673	0430-0059
OUTLANDER 650 6X6 15-18	0430-0674	0430-0717
OUTLANDER 650 STD 4X4 13-15	0430-0674	0430-0717
OUTLANDER DPS 650 EFI 17-19	0430-0674	0430-0717
OUTLANDER MAX 650 STD 4X4 06-12	0430-0673	0430-0059
OUTLANDER MAX 650 STD 4X4 13-15	0430-0674	0430-0717
OUTLANDER MAX 650 XT 4X4 13-14	0430-0674	0430-0717
OUTLANDER STD 650 EFI 17-19	0430-0674	0430-0717
QUEST 650 STD / XT 02-04	0430-0674	0430-0717
TRAXTER 650 04-05	0430-0674	0430-0717
OUTLANDER 800 (ALL) 4X4 06-12	0430-0673	0430-0059
OUTLANDER 800R STD 4X4 12-15	0430-0674	0430-0717
OUTLANDER 800R XMR 15	0430-0674	0430-0717
OUTLANDER 800R XT 4X4 13-14	0430-0674	0430-0717
OUTLANDER MAX 800 LTD 4X4 07-12	0430-0673	0430-0059
OUTLANDER MAX 800R EFI 15	0430-0674	0430-0717
OUTLANDER MAX 800R STD 4X4 12-14	0430-0674	0430-0717
OUTLANDER 850 16-19	0430-0674	0430-0717
OUTLANDER MAX 850 (ALL) 16-19	0430-0674	0430-0717
OUTLANDER 1000 DPS 12-19	0430-0674	0430-0717
OUTLANDER 1000 EFI 6X6 15-18	0430-0674	0430-0717
OUTLANDER 1000 XMR 13-19	0430-0674	0430-0717
OUTLANDER 1000 XT 12-19	0430-0674	0430-0717
OUTLANDER 1000 XTP 13-19	0430-0674	0430-0717
OUTLANDER MAX 1000 13-19	0430-0674	0430-0717
HONDA		
TRX200 90-91	0430-0722	0430-0058
TRX200D 91-97	0430-0722	0430-0058
TRX300 FOURTRAX 93-00	0430-0724	0430-0058
TRX300FW FOURTRAX 4X4 88-00	0430-0724	0430-0058
TRX350FE 00-06	0430-0722	0430-0058
TRX350FM FOURTRAX RANCHER 00-06	0430-0722	0430-0058
TRX350TE 00-06	0430-0722	0430-0058
TRX350TM FOURTRAX RANCHER 00-06	0430-0722	0430-0058
TRX400FA 04-07	0430-0722	0430-0058
TRX400FGA FOURTRAX RANCHER 4X4 04-07	0430-0722	0430-0058
TRX400FW FOURTRAX FOREMAN 4X4 95-03	0430-0722	0430-0058
TRX420 TE 07-13	0430-0722	0430-0058
TRX420 FA IRS 09-14	0430-0724	0430-0058
TRX420 FA SOLID AXLE 14-19	0430-0724	0430-0058
TRX420 FE 07-19	0430-0724	0430-0058
TRX420 FM 07-19	0430-0724	0430-0058

FITS MODEL	UPGRADE KIT PART #	REPL. TIE ROD ENDS PART #
TIE ROD ASSEMBLY UPGRADE KITS (CON'T)		
HONDA (CON'T)		
TRX420 FPA IRS 09-14	0430-0724	0430-0058
TRX420 FPE 09-10	0430-0724	-
TRX420 FPE 11-13	0430-0724	0430-0058
TRX420 FPM 09-10	0430-0724	-
TRX420 FPM 11-13	0430-0724	0430-0058
TRX420 TE 14-16	0430-0724	0430-0058
TRX420 TM 14-19	0430-0724	0430-0058
TRX420 FA IRS 15-17	0430-0725	0430-0058
TRX420 FA IRS 18-19	0430-0725	-
TRX450ES 98-01	0430-0725	0430-0058
TRX450FE/FM 02-04	0430-0725	0430-0058
TRX450S 98-00	0430-0725	0430-0058
TRX450S 01	0430-0725	-
TRX500FA 01-14	0430-0723	-
TRX500FA 15-19	0430-0725	-
TRX500FM IRS 15-17	0430-0725	0430-0058
TRX500FM IRS 18-19	0430-0725	-
TRX500FM SOLID AXLE 14-19	0430-0725	-
TRX650 RINCON 03-05	0430-0723	-
TRX680 RINCON 06-19	0430-0723	-
JOHN DEERE		
TRAIL BUCK 650 ALL	0430-0674	0430-0717
KAWASAKI		
KLF220 BAYOU 88-02	0430-0633	0430-0066
KLF250 BAYOU 03-11	0430-0633	0430-0066
KLF300C BAYOU 4X4 89-05	0430-0672	0430-0066
KLF400 BAYOU 1993-99	0430-0672	0430-0066
KVF400A PRAIRIE 4X4 97-98	0430-0672	0430-0066
KVF400C PRAIRIE 4X4 98-00	0430-0672	0430-0066
KVF650 I BRUTE FORCE 06-13	0430-0600	0430-0066
KVF750 BRUTE FORCE 05-19	0430-0600	0430-0066
POLARIS		
TRAIL BLAZER 250 97-06	0430-0730	0430-0070
XPLORER 250 4X4 00-02	0430-0729	0430-0070
XPLORER 300 4X4 98-99	0430-0729	0430-0070
XPRESS 300 98-99	0430-0730	0430-0070
HAWKEYE 325 2X4 15	0430-0730	0430-0070
MAGNUM 325 2X4 00-02	0430-0730	0430-0070
MAGNUM 325 4X4 00-02	0430-0729	0430-0070
SPORTSMAN 325 ETX EFI 15	0430-0730	0430-0070
SPORTSMAN 325 ETX EFI MD 15	0430-0730	0430-0070
TRAIL BOSS 325 00-02	0430-0730	0430-0070
XPEDITION 325 00-02	0430-0729	0430-0070
ATP 330 4X4 04-05	0430-0729	0430-0070
MAGNUM 330 2X4 03-05	0430-0730	0430-0070
MAGNUM 330 4X4 05	0430-0729	0430-0070
MAGNUM 330 4X4 AA AB AC 03-04	0430-0729	0430-0070
MAGNUM 330 4X4 FB 03-04	0430-0729	0430-0070
TRAIL BLAZER 330 08-09	0430-0730	0430-0070
TRAIL BLAZER 330 10-13	0430-0729	0430-0070
TRAIL BOSS 330 03-09	0430-0730	0430-0070
TRAIL BOSS 330 10-13	0430-0729	0430-0070
SPORTSMAN 335 99-00	0430-0729	0430-0070
HAWKEYE 400 HO 2X4 12-14	0430-0730	0430-0070
SPORTSMAN 400 4X4 02-03	0430-0729	0430-0070
SPORTSMAN 400 4X4 04	0430-0730	0430-0070
SPORTSMAN 400 4X4 AA AE AG 04	0430-0729	0430-0070
SPORTSMAN 400 4X4 AQ-AV 04	0430-0729	0430-0070
SPORTSMAN 400 HO 4X4 11-14	0430-0730	0430-0070
TRAIL BLAZER 400 03	0430-0729	0430-0070
XPLORER 400L 4X4 98-02	0430-0729	0430-0070
MAGNUM 425 4X4 98	0430-0729	0430-0070
XPEDITION 425 00-02	0430-0729	0430-0070
SPORTSMAN 450 06	0430-0730	0430-0070
SPORTSMAN 450 EFI MD 16	0430-0730	0430-0070
SPORTSMAN 450 HD 2X4 18	0430-0730	0430-0070
SPORTSMAN 450 HO 16-19	0430-0730	0430-0070
SPORTSMAN 450 HO 2X4 MD 16	0430-0730	0430-0070
DIESEL 455 4X4 00-01	0430-0729	0430-0070
ATP 500 4X4 04-05	0430-0729	0430-0070
BIG BOSS 500 6X6 99-03	0430-0729	0430-0070
MAGNUM 500 2X4 HDS 02	0430-0729	0430-0070
SPORTSMAN 500 4X4 98-13	0430-0729	0430-0070
SPORTSMAN 500 4X4 HO 05-13	0430-0730	0430-0070

FITS MODEL	UPGRADE KIT PART #	REPL. TIE ROD ENDS PART #
TIE ROD ASSEMBLY UPGRADE KITS (CON'T)		
POLARIS (CON'T)		
SPORTSMAN 500 EFI 06-08	0430-0730	-
SPORTSMAN 500 EFI 09	0430-0730	0430-0070
SPORTSMAN 500 X2 06-09	0430-0730	0430-0070
SPORTSMAN TOURING 500 08-13	0430-0730	0430-0070
WORKER 500 4X4 00-02	0430-0729	0430-0070
SPORTSMAN 550 11-13	0430-0866	-
SPORTSMAN 550 EPS 10-14	0430-0866	-
SPORTSMAN 550 X2 10-14	0430-0866	-
SPORTSMAN 550 X2 EPS LE 14	0430-0941	-
SPORTSMAN 550 X2 INTL 14	0430-0866	-
SPORTSMAN 550 XP 10-14	0430-0866	-
SPORTSMAN 550 XP EPS HD INTL 14	0430-0941	-
SPORTSMAN TOURING 550 EPS 10-14	0430-0866	-
SPORTSMAN 570 EFI 14-19	0430-0730	0430-0070
SPORTSMAN 570 EFI X2 EPS 15-19	0430-0730	0430-0070
SPORTSMAN 570 EFI X2 EPS EU 15	0430-0730	-
SPORTSMAN 570 EPS EU 17-18	0430-0730	-
SPORTSMAN 570 HD 15	0430-0730	0430-0070
SPORTSMAN 570 HD EFI 14	0430-0730	0430-0070
SPORTSMAN 570 X2 EPS MD 17	0430-0730	-
SPORTSMAN TOURING 570 EFI 14-19	0430-0730	0430-0070
SPORTSMAN 600 4X4 03	0430-0729	0430-0070
SPORTSMAN 600 4X4 05	0430-0730	0430-0070
SPORTSMAN 700 4X4 02-03	0430-0729	0430-0070
SPORTSMAN 700 4X4 05-07	0430-0730	0430-0070
SPORTSMAN X2 700 EFI 08	0430-0730	0430-0070
SPORTSMAN 800 EFI 05-14	0430-0730	0430-0070
SPORTSMAN 800 EFI 6X6 09-14	0430-0730	0430-0070
SPORTSMAN 800 HD EFI 09	0430-0730	0430-0070
SPORTSMAN TOURING 800 EFI 08-09	0430-0730	0430-0070
SPORTSMAN X2 800 EFI 07-09	0430-0730	0430-0070
SPORTSMAN 850 SP 15-18	0430-0866	-
SPORTSMAN 850 WV 14	0430-0941	-
SPORTSMAN 850 XP HD EPS MD 15	0430-0941	-
SPORTSMAN TOURING 850 19	0430-0866	-
SPORTSMAN TOURING 850 EPS 14	0430-0866	-
SPORTSMAN TOURING 850 SP 15-18	0430-0866	-
SPORTSMAN TOURING 850 INTL 14	0430-0941	-
SPORTSMAN TOURING 850 SP EU 15	0430-0941	-
SPORTSMAN TOURING 850 SP MD 15	0430-0941	-
SPORTSMAN TOURING EPS 850 10-13	0430-0866	-
SPORTSMAN X2 850 11	0430-0866	-
SPORTSMAN XP 850 EPS 09-14	0430-0866	-
SPORTSMAN 1000 HIGH LIFTER 16-19	0430-0941	-
SPORTSMAN 1000 XP 15-18	0430-0941	-
SPORTSMAN TOURING 1000 15-19	0430-0941	-
SUZUKI		
LT-230E 87-93	0430-0672	0430-0066
LT-230S 85-90	0430-0672	0430-0066
LT-F230 86-87	0430-0672	0430-0066
LT-F250 OZARK 02-03	0430-0671	0430-0066
LT-A400F 4WD KING QUAD 08-18	0430-0566	0430-0066
LT-A400 EIGER 02-07	0430-0566	0430-0066
LT-F400F 4WD KING QUAD 08-18	0430-0566	0430-0066
LT-A500F VINSON 02-03	0430-0566	0430-0066
LT-F500F VINSON 04-07	0430-0317	0430-0227
TEXTRON		
450 XC 18	0430-0566	0430-0719
WILDCAT X LTD EPS 18	0430-0777	0430-0776
YAMAHA		
YFB250FW TIMBERWOLF 94-00	0430-0321	0430-0227
YFM350 GRIZZLY IRS 07-11	0430-0727	0430-0057
YFM350 WARRIOR 87-04	0430-0316	0430-0227
YFM350FA BRUIN 4WD 04-06	0430-0727	0430-0057
YFM350FGW GRIZZLY 4WD 07-11	0430-0727	0430-0057
YFM350FGW GRIZZLY 4WD 12-14	0430-0315	0430-0227
YFM350FW BIG BEAR 87-97	0430-0321	0430-0227
YFM350FW BIG BEAR 98-99	0430-0315	0430-0227
YFM350GW GRIZZLY 2WD 07-11	0430-0727	0430-0057
YFM350U BIG BEAR 96-97	0430-0321	0430-0227
YFM350U BIG BEAR 98-99	0430-0315	0430-0227
YFM350FX WOLVERINE 95-05	0430-0315	0430-0227
YFM350DX WOLVERINE 06-09	0430-0727	0430-0057
YFM400 BIG BEAR 4WD 00-06	0430-0727	0430-0057

FITS MODEL	UPGRADE KIT PART #	REPL. TIE ROD ENDS PART #
TIE ROD ASSEMBLY UPGRADE KITS (CON'T)		
YAMAHA (CON'T)		
YFM400 BIG BEAR IRS 07-12	0430-0727	0430-0057
YFM400 GRIZZLY IRS 07-08	0430-0728	0430-0615
YFM400 KODIAK 4WD 93-02	0430-0321	0430-0227
YFM400 KODIAK 4WD 03-04	0430-0727	0430-0057
YFM400 KODIAK 4WD 05-06	0430-0728	0430-0615
YFM450 GRIZZLY IRS 07-12	0430-0728	0430-0615
YFM450 GRIZZLY EPS 13-14	0430-0315	0430-0227
YFM450 KODIAK 03-04	0430-0727	0430-0057
YFM450 KODIAK 05-06	0430-0728	0430-0615
YFM45FX WOLVERINE 450 4X4 06-10	0430-0727	0430-0057
YFM550 GRIZZLY 09-14	0430-0320	0430-0227
YFM660 GRIZZLY 02-08	0430-0320	0430-0227
YFM700 GRIZZLY EPS 08-13	0430-0320	0430-0227

TIE ROD ENDS

Contains inner and outer tie rod ends that are designed to replace loose and worn out tie rod ends. Two required per vehicle.



FITS MODEL	UPGRADE KIT PART #	REPL. TIE ROD ENDS PART #
TIE ROD ENDS		
ARCTIC CAT		
50 Y-6 YOUTH 04-05	0430-0053	
50 2X4 08	0430-0062	
50 Y-6 04-05	0430-0053	
50 Y-6 06	0430-0307	
90 2-STROKE 02-04	0430-0053	
90 4-STROKE 04-05	0430-0053	
90 UTILITY 2X4 06	0430-0307	
90 UTILITY 2X4 07-16	0430-0062	
ALTEIRA 90 17	0430-0062	
150 UTILITY 09-12	0430-0065	
250 2X4 99-05	0430-0453	
250 2X4 06-09	0430-0065	
250 4X4 01-05	0430-0453	
250 DVX 06-08	0430-0065	
300 2X4 98-04	0430-0453	
300 2X4 10-16	0430-0065	
300 4X4 98-05	0430-0453	
300 DVX 09-15	0430-0065	
350 CR 12	0430-0062	
350 UTILITY 4X4 11	0430-0062	
366 FIS W/AT 08-11	0430-0453	
375 2X4 W/AT 02	0430-0453	
375 4X4 W/AT 02	0430-0453	
400 2X4 98-01	0430-0453	
400 4X4 98-00	0430-0453	
400 4X4 14-15	0430-0719	
400 4X4 W/AT 03-04	0430-0453	
400 4X4 W/MT 01-04	0430-0453	
400 DVX 04-08	0430-0065	
400 FIS 2X4 W/AT 03-04	0430-0453	
400 FIS 2X4 W/MT 03-04	0430-0453	
400 FIS 4X4 TRV 06-14	0430-0453	
400 FIS 4X4 W/AT 03-08	0430-0453	
400 FIS 4X4 W/AT 13-14	0430-0719	
400 FIS 4X4 W/MT 02-08	0430-0453	
400 TBX 4X4 04-06	0430-0453	
400 VP 4X4 W/AT 05-06	0430-0453	
400 VP 4X4 W/MT 05-06	0430-0453	
ALTEIRA 400 16-17	0430-0719	
425 4X4 11-12	0430-0062	
450 4X4 14-15	0430-0719	
450 H1 10-11	0430-0453	
450 TRV 12	0430-0453	
450 XC 11-12	0430-0062	
450 XC 14-17	0430-0719	
450I TRV EFI 11-12	0430-0453	
450I TRV GT EFI 12	0430-0453	
ALTEIRA 450 16	0430-0719	

FITS MODEL	PART #
TIE ROD ENDS (CON'T)	
ARCTIC CAT (CON'T)	
454 2X4 97-98	0430-0453
454 4X4 96-98	0430-0453
500 4X4 98-99	0430-0453
500 4X4 W/AT 00-02	0430-0453
500 4X4 W/MT 00-01	0430-0453
500 EFI 4X4 W/AT 13-14	0430-0453
500 EFI 4X4 W/AT 15-17	0430-0865
500 FIS 4X4 W/AT 02-09	0430-0453
500 FIS 4X4 W/MT 02-09	0430-0453
500 FIS TBX 4X4 02-06	0430-0453
500 FIS TRV 4X4 03-08	0430-0453
500 TRV 13-14	0430-0453
500 TRV 15	0430-0865
500 XR 15	0430-0865
500 XT EFI 13-14	0430-0453
ALTEIRA 500 17	0430-0719
ALTEIRA 500 XT EPS 16	0430-0865
ALTEIRA TRV 500 17	0430-0865
550 EFI 4X4 12-13	0430-0453
550 GT EFI 4X4 12	0430-0453
550 H1 FIS 4X4 09-11	0430-0453
550 TRV 4X4 W/AT 09-13	0430-0453
550 TRV XT/LTD 14-15	0430-0865
550 XR EFI/XT/LTD 15	0430-0865
550 XT EFI 4X4 13	0430-0453
550 XT EFI 4X4 14	0430-0865
550 XT LTD EFI 12-14	0430-0453
ALTEIRA TRV 550 XT EPS 16-17	0430-0865
650 4X4 H1 05-11	0430-0453
650 4X4 H1 MUD PRO 10-11	0430-0453
650 4X4 W/AT V2 04-06	0430-0453
650 H1 TBX 07-09	0430-0453
650 TRV 09	0430-0865
650I 4X4 12	0430-0453
700 AT EFI 06	0430-0453
700 DIESEL 07-14	0430-0453
700 DIESEL 15	0430-0865
700 EFI 07-08	0430-0453
700 EFI / LTD 11-14	0430-0453
700 EFI H1 08-11	0430-0453
700 EFI H1 MUDPRO 09-11	0430-0453
700 GT EFI 12	0430-0453
700 LTD EFI 13	0430-0453
700 TBX 10-14	0430-0453
700 TBX 15-17	0430-0865
700 TRV 08-13	0430-0453
700 TRV 14-15	0430-0865
700 XR 15	0430-0865
700 XT 13-14	0430-0453
700I EFI MUDPRO / LTD 12-13	0430-0453
700I EFI MUDPRO / LTD 14-15	0430-0865
700I H1 TRV GT EFI 11-12	0430-0453
ALTEIRA 700 16-17	0430-0865
ALTEIRA 700 XT EPS 17	0430-0865
ALTEIRA TRV 700 XT EPS 17	0430-0865
1000 LTD MUDPRO 15-17	0430-0865
1000 TRV 13	0430-0453
1000 TRV / CRUISER 09-12	0430-0453
1000 TRV GT 12	0430-0453
1000 TRV XT/LTD 15	0430-0865
1000 XT 13	0430-0453
1000 XT 14-17	0430-0865
1000I GT 12	0430-0453
1000I LTD EFI MUDPRO 12-14	0430-0453
ALTEIRA TRV 1000 XT 17	0430-0865
H2 MUDPRO 10-11	0430-0453
H2 THUNDERCAT 08-11	0430-0453
WILDCAT 1000 14	0430-0776
WILDCAT 1000 LATE BUILD 13	0430-0776
WILDCAT 4 13-14	0430-0776
WILDCAT 4 LTD 14	0430-0776
WILDCAT 4X 14-15	0430-0776
WILDCAT 6T 12-13	0430-0776
WILDCAT LTD 13-14	0430-0776
WILDCAT X 13	0430-0776
WILDCAT X / LTD 14-16	0430-0776

PLOWS
WINCHES
UTV
RACKS
IMPLEMENT & TOWING
LUGGAGE
BODY
CONTROLS
ELECTRICAL
WHEELS & TIRES
SUSPENSION & DRIVE
BRAKING
ENGINE
RIDER
GARAGE
PROMO

SUSPENSION & DRIVE

FITS MODEL	PART #	FITS MODEL	PART #	FITS MODEL	PART #
TIE ROD ENDS (CON'T)		TIE ROD ENDS (CON'T)		TIE ROD ENDS (CON'T)	
CAN-AM		CAN-AM (CON'T)		KAWASAKI	
DS 50 02-06	0430-0053	OUTLANDER MAX 800R STD 4X4 09-11	0430-0059	KLF110 87-88	0430-0062
QUEST 50 03	0430-0053	OUTLANDER MAX 800R STD 4X4 12-14	0430-0717	KLF185 BAYOU 85-88	0430-0062
DS 90 2 STROKE 02-06	0430-0053	OUTLANDER MAX 800R XT 4X4 09-12	0430-0059	KLF220 BAYOU 88-02	0430-0062
DS 90 4 STROKE 02-07	0430-0053	OUTLANDER MAX 800R XT 4X4 13-14	0430-0717	KLF250 BAYOU 03-11	0430-0062
QUEST 90 4 STROKE 03	0430-0053	OUTLANDER 850 16	0430-0717	KEF300 LAKOTA 95-03	0430-0062
RALLY 175 03-07	0430-0053	OUTLANDER 850 DPS 16-19	0430-0717	KLF300C BAYOU 4X4 89-05	0430-0062
OUTLANDER 330 04-05	0430-0059	OUTLANDER 850 XMR 16	0430-0717	KVF300 BRUTE FORCE 12-18	0430-0065
OUTLANDER 330 4X4 05	0430-0059	OUTLANDER 850 XT 16	0430-0717	KVF300A PRAIRIE 4X4 99-00	0430-0062
OUTLANDER 400 03-04	0430-0059	OUTLANDER 850 XTP 16	0430-0717	KVF300A PRAIRIE 4X4 01-02	0430-0063
OUTLANDER 400 STD 2X4 05	0430-0059	OUTLANDER MAX 850 DPS 17-19	0430-0717	KVF300B PRAIRIE 2X4 99-00	0430-0062
OUTLANDER 400 STD 4X4 05-15	0430-0059	OUTLANDER MAX 850 XT 16	0430-0717	KVF300B PRAIRIE 2X4 01-02	0430-0063
OUTLANDER 400 XT 4X4 04-14	0430-0059	OUTLANDER MAX 850 XTP 16	0430-0717	KVF300B PRAIRIE 4X4 03-13	0430-0059
OUTLANDER MAX 400 EFI/STD/XT 15	0430-0059	MAVERICK 900 X3 17	0430-0746	KVF360A PRAIRIE 4X4 03-13	0430-0059
OUTLANDER MAX 400 STD 4X4 05-14	0430-0059	MAVERICK 900 X3 XDS 17	0430-0746	KVF360B PRAIRIE 03-11	0430-0059
OUTLANDER MAX 400 XT 4X4 06-14	0430-0059	MAVERICK 900 X3 XRS 17	0430-0746	KVF360C PRAIRIE 4X4 03-13	0430-0059
OUTLANDER DPS 450 EFI 16-19	0430-0717	OUTLANDER 1000 DPS 12-19	0430-0717	KLF400 BAYOU 93-99	0430-0062
OUTLANDER L 450 EFI 15-16	0430-0717	OUTLANDER 1000 XMR 13-19	0430-0717	KVF400A PRAIRIE 4X4 97-98	0430-0062
OUTLANDER L MAX 450 EFI 15-16	0430-0717	OUTLANDER 1000 XT 12-19	0430-0717	KVF400B PRAIRIE 98	0430-0062
OUTLANDER MAX 450 EFI 17	0430-0717	OUTLANDER 1000 XTP 13-19	0430-0717	KVF400C PRAIRIE 4X4 99-00	0430-0062
OUTLANDER MAX DPS 450 EFI 16-19	0430-0717	OUTLANDER MAX 1000 13-19	0430-0717	KVF400C PRAIRIE 4X4 01-02	0430-0063
OUTLANDER MAX STD 450 EFI 18-19	0430-0717	OUTLANDER MAX 1000 LTD 15-16	0430-0717	KVF400D PRAIRIE 99-00	0430-0062
OUTLANDER STD 450 EFI 17-19	0430-0717	OUTLANDER MAX 1000 XT 13-19	0430-0717	KVF400D PRAIRIE 01-02	0430-0063
OUTLANDER 500 LTD 4X4 10	0430-0059	OUTLANDER MAX 1000 XTP 13-19	0430-0717	KVF650 BRUTE FORCE 05-13	0430-0224
OUTLANDER 500 STD 4X4 07-12	0430-0059			KVF650 I BRUTE FORCE 06-13	0430-0056
OUTLANDER 500 STD 4X4 13-15	0430-0717	CF-MOTO		KVF650 PRAIRIE 02-03	0430-0224
OUTLANDER 500 XT 4X4 07-12	0430-0059	C FORCE 500 X5 L CARB 14	0430-0227	KFX 700 V-FORCE 04-09	0430-0225
OUTLANDER 500 XT 4X4 13-14	0430-0717	C FORCE 500 X5 L EFI 14	0430-0227	KVF700 PRAIRIE 04-06	0430-0224
OUTLANDER L 500 EFI 15	0430-0717	C FORCE 500 X5 S CARB 14	0430-0227	KVF750 BRUTE FORCE 05-19	0430-0056
OUTLANDER L MAX 500 EFI 15	0430-0717	C FORCE 500 X5 S EFI 14	0430-0227	KVF750 BRUTE FORCE EPS 12-19	0430-0056
OUTLANDER MAX 500 EFI 15	0430-0717	C FORCE 500-2 L 11-12	0430-0227		
OUTLANDER MAX 500 STD 4X4 07-12	0430-0059	C FORCE 500-2 S 07-14	0430-0227	KYMCO	
OUTLANDER MAX 500 STD 4X4 13-14	0430-0717	C FORCE 500-2A L 07-14	0430-0227	MAXXER 50 ALL	0430-0053
OUTLANDER MAX 500 XT 4X4 07-12	0430-0059	C FORCE X5 500 L CARB 11-13	0430-0227	MONGOOSE 50 03-05	0430-0053
OUTLANDER MAX 500 XT 4X4 13-14	0430-0717	C FORCE X5 500 L EFI 11-13	0430-0227	MONGOOSE 50 4 STROKE 06-09	0430-0053
QUEST 500 02-04	0430-0717	C FORCE X5 500 S CARB 11-13	0430-0227	MXER 50 ALL	0430-0053
QUEST 500 XT 02-04	0430-0717	C FORCE X5 500 S EFI 11-12	0430-0227	MXU 50 ALL	0430-0065
TRAXTER 500 99-05	0430-0717	C FORCE X6 600 13	0430-0227	MONGOOSE 70 06-09	0430-0053
TRAXTER 500 AUTO CVT 05	0430-0717	C FORCE X6 600 L/C FORCE X6 600 S 11-12	0430-0227	MONGOOSE 90 04-08	0430-0053
OUTLANDER DPS 570 EFI 16-19	0430-0717	C FORCE X6 X-LANDER 12	0430-0227	MXER 150 04-05	0430-0065
OUTLANDER L 570 EFI 16	0430-0717	C FORCE X600 L 14	0430-0227	MXU 150 05-08	0430-0065
OUTLANDER LE 570 EFI 16	0430-0717	C FORCE X600 S 14	0430-0227	KXR250 ALL	0430-0065
OUTLANDER MAX 570 EFI 16-17	0430-0717	C FORCE X8 X-LANDER 12-14	0430-0227	MAXXER250 ALL	0430-0065
OUTLANDER MAX DPS 570 EFI 16-19	0430-0717			MONGOOSE 250 04-08	0430-0065
OUTLANDER MAX STD 570 EFI 18-19	0430-0717	HONDA		MXU250 04-08	0430-0065
OUTLANDER STD 570 EFI 17-19	0430-0717	TRX70 86-87	0430-0051	MAXXER300 ALL	0430-0065
OUTLANDER XMR 570 EFI 16-19	0430-0717	TRX90 93-19	0430-0051	MONGOOSE 300 05-10	0430-0065
DS650 00-07	0430-0717	TRX125 85-88	0430-0051	MXU 300 05-10	0430-0065
OUTLANDER 650 6X6 15-18	0430-0717	TRX200 84	0430-0051	MAXXER 375 10	0430-0453
OUTLANDER 650 STD 4X4 06-12	0430-0059	TRX200/TRX200D 90-97	0430-0058	MXU 375 09-10	0430-0453
OUTLANDER 650 STD 4X4 13-15	0430-0717	TRX200SX 86-88	0430-0051	MXU 375 UTILITY 10	0430-0453
OUTLANDER 650 XMR 13-15	0430-0717	FL250 1977-84	0430-0051	MXU 400 ALL	0430-0065
OUTLANDER 650 XT 4X4 06-12	0430-0059	TRX250 FOURTRAX 85-86	0430-0051	MAXXER 450I ALL	0430-0453
OUTLANDER 650 XT 4X4 13-14	0430-0717	TRX250 FOURTRAX 87	0430-0055	MXU 450I ALL	0430-0453
OUTLANDER DPS 650 EFI 17-19	0430-0717	TRX250 RECON 97-01	0430-0058	MXU 500 07-09	0430-0065
OUTLANDER MAX 650 STD 4X4 06-12	0430-0059	TRX250R 86-89	0430-0056	MXU 500 2WD/4WD ALL	0430-0065
OUTLANDER MAX 650 STD 4X4 13-15	0430-0717	TRX250TE RECON 02-19	0430-0058	MXU 500I ALL	0430-0453
OUTLANDER MAX 650 XT 4X4 06-12	0430-0059	TRX250TM RECON 02-19	0430-0058		
OUTLANDER MAX 650 XT 4X4 13-14	0430-0717	TRX300 FOURTRAX 88-00	0430-0058	POLARIS	
OUTLANDER STD 650 EFI 17-19	0430-0717	TRX300FW FOURTRAX 4X4 88-00	0430-0058	SPORTSMAN 90 01-06	0430-0307
QUEST 650 STD/XT 02-04	0430-0717	TRX350 86-87	0430-0053	SPORTSMAN 90 07-16	0430-0065
TRAXTER 650 04-05	0430-0717	TRX350D 87-89	0430-0053	SPORTSMAN 110 16-19	0430-0065
TRAXTER 650 AUTO CVT 05	0430-0717	TRX350DF 00-06	0430-0058	RZR 170 09-19	0430-0065
OUTLANDER 800 STD 4X4 06-08	0430-0059	TRX350FM/TRX350TM FOURTRAX RANCHER 00-06	0430-0058	PHOENIX 200 06-09	0430-0062
OUTLANDER 800 XMR 11-12	0430-0059	TRX350TE 00-06	0430-0058	SAWTOOTH 200 06-07	0430-0062
OUTLANDER 800 XT 4X4 06-08	0430-0059	TRX400FA 04-07	0430-0058	BIG BOSS 250 4X6 89-92	0430-0069
OUTLANDER 800 XXX 11	0430-0059	TRX400FGA FOURTRAX RANCHER 4X4 04-07	0430-0058	BIG BOSS 250 6X6 91-93	0430-0071
OUTLANDER 800R STD 4X4 09-11	0430-0059	TRX400FW FOURTRAX FOREMAN 4X4 95-03	0430-0058	TRAIL BLAZER 250 90-95	0430-0069
OUTLANDER 800R STD 4X4 12-15	0430-0717	TRX420 FA IRS 09-19	0430-0058	TRAIL BLAZER 250 96	0430-0071
OUTLANDER 800R XMR 15	0430-0717	TRX450ES 98-01	0430-0058	TRAIL BLAZER 250 97-06	0430-0070
OUTLANDER 800R XT 4X4 09-12	0430-0059	TRX450FE/FM 02-04	0430-0058	TRAIL BOSS 250 88	0430-0069
OUTLANDER 800R XT 4X4 13-14	0430-0717	TRX450S 98-01	0430-0058	TRAIL BOSS 250 2X4 88-99	0430-0069
OUTLANDER MAX 800 LTD 4X4 07-08	0430-0059	TRX500FA 18-19	0430-0058	TRAIL BOSS 250 4X4 87-88	0430-0069
OUTLANDER MAX 800 STD 4X4 06-08	0430-0059	TRX500FM IRS 15-19	0430-0058	TRAIL BOSS 250 4X4 89-95	0430-0071
OUTLANDER MAX 800 XT 4X4 06-08	0430-0059			TRAIL BOSS 250 R/ES 88	0430-0069
OUTLANDER MAX 800R EFI 15	0430-0717	JOHN DEERE		300 4X4 94-95	0430-0071
OUTLANDER MAX 800R LTD 4X4 09-12	0430-0059	TRAIL BUCK 500 UTILITY ALL	0430-0717	BIG BOSS 300 6X6 94	0430-0071
		TRAIL BUCK 650 EX ALL	0430-0717	HAWKEYE 2X4 06-11	0430-0668
		TRAIL BUCK 650 EXT ALL	0430-0717	HAWKEYE 4X4 06-07	0430-0668
		TRAIL BUCK 650 ALL	0430-0717	SPORTSMAN 300 4X4 08-10	0430-0668

FITS MODEL	PART #
TIE ROD ENDS (CON'T)	
POLARIS (CON'T)	
XPLORER 250 4X4 00-02	0430-0070
300 2X4 94-95	0430-0069
XPLORER 300 4X4 96-97	0430-0071
XPLORER 300 4X4 98-99	0430-0070
XPRESS 300 96-97	0430-0071
XPRESS 300 98-99	0430-0070
HAWKEYE 325 2X4 15	0430-0070
MAGNUM 325 2X4/4X4 00-02	0430-0070
MAGNUM 325 4X4 HDS 02	0430-0070
MAGNUM 325 4X4 HDS AA 01	0430-0070
MAGNUM 325 4X4 HDS FB 01	0430-0070
SPORTSMAN 325 ETX EFI 15	0430-0070
SPORTSMAN 325 ETX EFI MD 15	0430-0070
TRAIL BOSS 325 00-02	0430-0070
XPEDITION 325 00-02	0430-0070
ATP 330 4X4 04-05	0430-0070
MAGNUM 330 2X4 03-05	0430-0070
MAGNUM 330 4X4 05	0430-0070
MAGNUM 330 4X4 AA AB AC 03-04	0430-0070
MAGNUM 330 4X4 FB 03-04	0430-0070
TRAIL BLAZER 330 08-13	0430-0070
TRAIL BOSS 330 03-13	0430-0070
SPORTSMAN 335 99-00	0430-0070
350L 2X4 93	0430-0069
350L 4X4 93	0430-0071
BIG BOSS 350L 6X6 93	0430-0071
SPORTSMAN 350 4X4 93	0430-0071
TRAIL BOSS 350L 2X4 90-92	0430-0069
TRAIL BOSS 350L 4X4 90-92	0430-0071
400L 2X4 94-95	0430-0069
400L 4X4 94	0430-0071
BIG BOSS 400L 6X6 94-97	0430-0071
HAWKEYE 400 HO 2X4 11	0430-00668
HAWKEYE 400 HO 2X4 12-14	0430-0070
MAGNUM 400L 6X6 96-97	0430-0071
SPORTSMAN 400 4X4 94-97	0430-0071
SPORTSMAN 400 4X4 02-05	0430-0070
SPORTSMAN 400 4X4 AA AE AG 04	0430-0070
SPORTSMAN 400 4X4 AQ-AV 04	0430-0070
SPORTSMAN 400 HO 4X4 09-10	0430-00668
SPORTSMAN 400 HO 4X4 11-14	0430-0070
TRAIL BLAZER 400 03	0430-0070
XPLORER 400L 4X4 95-97	0430-0071
XPLORER 400L 4X4 98-02	0430-0070
XPRESS 400L 2X4 96-97	0430-0071
MAGNUM 425 2X4 95	0430-0069
MAGNUM 425 2X4 96-97	0430-0071
MAGNUM 425 2X4 98	0430-0070
MAGNUM 425 4X4 95-97	0430-0071
MAGNUM 425 4X4 98	0430-0070
XPEDITION 425 00-02	0430-0070
450 HO 2X4 MD 16	0430-0070
SPORTSMAN 450 06	0430-0070
SPORTSMAN 450 EFI MD 16	0430-0070
SPORTSMAN 450 EPS QUAD 16	0430-0070
SPORTSMAN 450 EPS ZUG 16	0430-0070
SPORTSMAN 450 HD 2X4 18	0430-0070
SPORTSMAN 450 HO 16-19	0430-0070
SPORTSMAN 450 HO 2X4 MD 16	0430-0070
DIESEL 455 4X4 00-01	0430-0070
ACE 500 17-19	0430-0073
ATP 500 4X4 04-05	0430-0070
ATV 500 PRO 02	0430-0070
BIG BOSS 500 6X6 98-03	0430-0070
MAGNUM 500 2X4 HDS 00-02	0430-0070
SPORTSMAN 500 4X4 96-97	0430-0071
SPORTSMAN 500 4X4 98-00	0430-0070
SPORTSMAN 500 4X4 DUSE 01-02	0430-0070
SPORTSMAN 500 4X4 DUSE HO 01	0430-0070
SPORTSMAN 500 4X4 HO 01-13	0430-0070
SPORTSMAN 500 6X6 00-08	0430-0070
SPORTSMAN 500 EFI 06-09	0430-0070
SPORTSMAN 500 X2 06-09	0430-0070
SPORTSMAN TOURING 500 08-13	0430-0070
WORKER 500 4X4 00-02	0430-0070
SPORTSMAN 500 4X4 HO AA-AC-AE-AG 04	0430-0070

FITS MODEL	PART #
TIE ROD ENDS (CON'T)	
POLARIS (CON'T)	
SPORTSMAN 500 4X4 HO AO-AX 04	0430-0070
SPORTSMAN 500 4X4 RSE 00-02	0430-0070
XPLORER 500 97	0430-0071
SPORTSMAN 550 11-13	0430-0078
SPORTSMAN 550 EPS 10-14	0430-0078
SPORTSMAN 550 X2 10-14	0430-0078
SPORTSMAN 550 X2 EPS LE 14	0430-0078
SPORTSMAN 550 X2 INTL 14	0430-0078
SPORTSMAN 550 XP 10-14	0430-0078
SPORTSMAN 550 XP EPS HD INTL 14	0430-0078
SPORTSMAN TOURING 550 EPS 10-14	0430-0078
SPORTSMAN 570 EFI 14-19	0430-0070
SPORTSMAN 570 EPS QUAD 16	0430-0078
SPORTSMAN 570 SP 15-19	0430-0078
SPORTSMAN 570 SP EPS QUAD 15-16	0430-0078
SPORTSMAN 570 SP MD 15-16	0430-0078
SPORTSMAN TOURING 570 EFI 14-19	0430-0070
SPORTSMAN 600 4X4 03-05	0430-0070
SPORTSMAN 700 4X4 02-07	0430-0070
SPORTSMAN 700 EFI 05-07	0430-0070
SPORTSMAN MV7 05	0430-0070
SPORTSMAN X2 700 EFI 08	0430-0070
SPORTSMAN 800 EFI 05-14	0430-0070
SPORTSMAN 800 EFI 6X6 09-14	0430-0070
SPORTSMAN 800 HO EFI 09	0430-0070
SPORTSMAN TOURING 800 EFI 08-09	0430-0070
SPORTSMAN X2 800 EFI 07-09	0430-0070
SPORTSMAN 850 HIGH LIFTER 17-19	0430-0078
SPORTSMAN 850 SP 15-18	0430-0078
SPORTSMAN 850 WV 14	0430-0078
SPORTSMAN 850 XP HO EPS MD 15	0430-0078
SPORTSMAN TOURING 850 13-19	0430-0078
SPORTSMAN X2 850 11	0430-0078
SPORTSMAN XP 850 10-13	0430-0078
SPORTSMAN XP 850 EPS 10-14	0430-0078
SPORTSMAN 1000 HIGH LIFTER 16-19	0430-0078
SPORTSMAN 1000 MD 15	0430-0078
SPORTSMAN 1000 XP 15-18	0430-0078
SPORTSMAN TOURING 1000 15-19	0430-0078
SUZUKI	
LT-50 84-87	0430-0062
LT-80 87-06	0430-0064
LT-125 83-84	0430-0062
LT-125 85-87	0430-0064
LT-160 03-04	0430-0052
LT-160E 89-92	0430-0052
LT-F160 91-01	0430-0052
LT-185 84-87	0430-0064
LT-230E 87-93	0430-0064
LT-230G 85-86	0430-0064
LT-230S 85-90	0430-0064
LT-F230 86-87	0430-0064
LT-250EF 85-86	0430-0064
LT-250S 89-90	0430-0064
LT-4WD 250 QUAD RUNNER 87-98	0430-0535
LT-F250 2WD 88-01	0430-0064
LT-F250 OZARK 02	0430-0064
LT-F250 OZARK 03	0430-0062
LT-F250 OZARK 04-14	0430-0065
LT-F250F 4WD QUAD RUNNER 99-02	0430-0535
LT-300E 87-89	0430-0064
LT-F300F KING QUAD 99-02	0430-0535
LT-F4WDX KING QUAD 300 91-98	0430-0535
LT-A400 2WD KING QUAD 08-09	0430-0065
LT-A400 EIGER 2WD 02-04	0430-0064
LT-A400 EIGER 2WD 06-07	0430-0065
LT-A400F 4WD KING QUAD 08-18	0430-0065
LT-A400F EIGER 4WD 02-04	0430-0064
LT-A400F EIGER 4WD 05-07	0430-0065
LT-F400 2WD KING QUAD 08-09	0430-0065
LT-F400F EIGER 4WD 02-04	0430-0064
LT-F400F EIGER 4WD 05-07	0430-0065
LTA-450 X KING QUAD 07-10	0430-0454
LT-A500F VINSON 02-03	0430-0062
LT-A500F VINSON 04-07	0430-0065
LT-A500X 09-10	0430-0227

FITS MODEL	PART #
TIE ROD ENDS (CON'T)	
SUZUKI (CON'T)	
LT-F400 EIGER 2WD 02-04	0430-0064
LT-F400 EIGER 2WD 07	0430-0065
LT-F400F 4WD KING QUAD 08-18	0430-0065
LT-A500X 11-18	0430-0454
LT-A500XP POWER STEERING 11-18	0430-0227
LT-F500F VINSON 03	0430-0062
LT-F500F VINSON 04-07	0430-0065
LTA-700 X KING QUAD 05-07	0430-0454
LTV-700F TWIN PEAKS 04-06	0430-0224
LTA-750 X KING QUAD 08-14	0430-0454
LTA-750 X KING QUAD 15	0430-0227
LTA-750 X KING QUAD 16-18	0430-0454
LTA-750 XP KING QUAD POWER STEERING 11-15	0430-0227
LTA-750 XP KING QUAD POWER STEERING 16-18	0430-0454
TEXTRON	
90 DVX 18	0430-0062
ALTERRA 90 18	0430-0062
150 UTILITY 18	0430-0065
ALTERRA 300 18	0430-0065
450 XC 18	0430-0719
ALTERRA 500 18	0430-0719
700 TBX 18	0430-0865
ALTERRA 700 18	0430-0865
ALTERRA 700 VLX 18	0430-0865
ALTERRA 700 VLX EPS 18	0430-0865
ALTERRA 700 XT EPS 18	0430-0865
WILDCAT X LTD EPS 18	0430-0776
YAMAHA	
YFA1 89-04	0430-0065
YFM125 GRIZZLY 04-13	0430-0065
YFM200 MOTO-4 86-89	0430-0065
YFS200 BLASTER 88-06	0430-0065
YFM225 MOTO-4 86-88	0430-0065
YFB250 TIMBERWOLF 92-98	0430-0065
YFB250FV TIMBERWOLF 94-00	0430-0065
YFM250 BEARTRACKER 99-04	0430-0057
YFM250 BIG BEAR 07-09	0430-0057
YFM250 MOTO-4 89-91	0430-0065
YFM250B BRUIN 05-06	0430-0057
YFM350 GRIZZLY IRS 07-11	0430-0057
YFM350 WARRIOR 87-04	0430-0065
YFM350BA BRUIN 2WD 04-06	0430-0057
YFM350ER MOTO-4 87-95	0430-0065
YFM350FA BRUIN 4WD 04-06	0430-0057
YFM350FGW GRIZZLY 4WD 07-11	0430-0057
YFM350FGW GRIZZLY 4WD 12-14	0430-0065
YFM350FW BIG BEAR 87-99	0430-0065
YFM350GW GRIZZLY 2WD 07-11	0430-0057
YFM350U BIG BEAR 96-99	0430-0065
YFM35FX WOLVERINE 95-05	0430-0065
YFM35X WOLVERINE 06-09	0430-0057
YFP350U TERRA PRO 88	0430-0065
YFM400 BIG BEAR 2WD 00-04	0430-0057
YFM400 BIG BEAR 4WD 00-06	0430-0057
YFM400 BIG BEAR IRS 07-12	0430-0057
YFM400 GRIZZLY IRS 07-08	0430-0615
YFM400 KODIAK 2WD 00-01	0430-0065
YFM400 KODIAK 2WD 03-04	0430-0057
YFM400 KODIAK 4WD 93-02	0430-0065
YFM400 KODIAK 4WD 03-04	0430-0057
YFM400 KODIAK 4WD 05-06	0430-0615
KODIAK 450 4WD 18-19	0430-0065
KODIAK 450 EPS 4WD 18-19	0430-0065
KODIAK 450 EPS 4WD ARMOR GREY 18	0430-0065
YFM450 GRIZZLY EPS 11-12	0430-0615
YFM450 GRIZZLY EPS 13-14	0430-0065
YFM450 GRIZZLY IRS 07-12	0430-0615
YFM450 GRIZZLY IRS 13-14	0430-0065
YFM450 KODIAK 03-04	0430-0057
YFM450 KODIAK 05-06	0430-0615
YFM45FX WOLVERINE 450 4X4 06-10	0430-0057
YFM550 GRIZZLY 09-14	0430-0065
YFM600 GRIZZLY 98-01	0430-0065
YFM660 GRIZZLY 02-08	0430-0065
KODIAK 700 4WD 16-19	0430-0065
YFM700 GRIZZLY 07-19	0430-0065

SUSPENSION & DRIVE

STEERING STEM BEARING AND SEAL KITS

Drop in replacement to upgrade OEM ball type bearing sets to taper bearings. Tapered roller bearings provide decreased maintenance, less wear, smooth operation and longer life. Comes complete with both upper and lower taper bearing cups, cones and seals.



FITS MODEL	PART #
STEERING STEM BEARING AND SEAL KITS	
CAN-AM	
RALLY 175 03-07	0410-0163 ¹
OUTLANDER 330 04-05	0410-0163 ¹
OUTLANDER 400 03-16	0410-0163 ¹
OUTLANDER 500 07-12	0410-0163 ¹
QUEST 500 02-03	0410-0163 ¹
RENEGADE 500 08-12	0410-0163 ¹
TRAXTER 500 99-05	0410-0163 ¹
OUTLANDER 650 07-12	0410-0163 ¹
QUEST 650 02-04	0410-0163 ¹
TRAXTER 650 04-05	0410-0163 ¹
OUTLANDER 800 06-12	0410-0163 ¹
RENEGADE 800 07-11	0410-0163 ¹
CF MOTO	
ATV 500	0410-0073 ¹
X-LANDER 500	0410-0073 ¹
HONDA	
ATC70 73-85	0410-0021
ATC90 73-78	0410-0021
TRX90 93-18	0410-0070 ¹
ATC110 79-85	0410-0021
ATC125M 84-87	0410-0021
ATC185 80-83	0410-0021
ATC200E 82-83	0410-0021
ATC200ES 84	0410-0021
ATC200M 84-85	0410-0021
ATC200S 84-86	0410-0021
ATC200X 83-87	0410-0041
TRX200 90-91	0410-0070 ¹
TRX200 96-97	0410-0070 ¹
TRX200D 90-97	0410-0070 ¹
ATC250ES 85-87	0410-0041
ATC250SX 85-87	0410-0041
TRX250 RECON 97-18	0410-0070 ¹
TRX300 FOURTRAX 88-92	0410-0070 ¹
TRX300 FOURTRAX 93-00	0410-0069 ¹
TRX300FW FOURTRAX 4X4 88-00	0410-0069 ¹
ATC350X 85-86	0410-0041
TRX350FM/FE/TE/TM 00-06	0410-0069 ¹
TRX400FA/FGA 04-07	0410-0069 ¹
TRX400FW FOURTRAX FOREMAN 4X4 95-03	0410-0069 ¹
TRX420FA 09-14	0410-0069 ¹
TRX420FE/FM 07-14	0410-0069 ¹
TRX420FPE/FPM 11-14	0410-0069 ¹
TRX420TE/TM 07-13	0410-0069 ¹
TRX420 FE/FM 14-17	0410-0235
TRX420 TE/TM 14-17	0410-0235
TRX450ES 98-01	0410-0069 ¹
TRX450FE/FM 02-04	0410-0069 ¹
TRX450S 98-01	0410-0069 ¹
TRX500FA 01-14	0410-0072 ¹
TRX500FA 04-09	0410-0072 ¹
TRX500FE/FM 05-11	0410-0072 ¹
TRX500FPA 09-14	0410-0072 ¹
TRX500TM 05-06	0410-0072 ¹
TRX500FE/FM 14-18	0410-0235
TRX650 RINCON 03-05	0410-0072 ¹
TRX680 RINCON 06-17	0410-0072 ¹
KAWASAKI	
KFX90 14-17	0410-0235
KLF185 BAYOU 85-88	0410-0085 ¹
KLF220 BAYOU 88-02	0410-0085 ¹
KLF250 BAYOU 03-11	0410-0085 ¹
KXF250 TECATE 87-88	0410-0085 ¹
KXT250 TECATE 84-87	0410-0022
KEF300 LAKOTA 95-03	0410-0085 ¹

FITS MODEL	PART #
STEERING STEM BEARING AND SEAL KITS (CON'T)	
KAWASAKI (CON'T)	
KLF300A BAYOU 86-87	0410-0085 ¹
KLF300B BAYOU 88-04	0410-0085 ¹
KLF300C BAYOU 4X4 89-04	0410-0085 ¹
KLF400 BAYOU 93-99	0410-0085 ¹
KVF400A PRAIRIE 4X4 97-99	0410-0085 ¹
KFX 700 V-FORCE 04-09	0410-0085 ¹
KVF750 BRUTE FORCE 12-17	0410-0233
POLARIS	
TRAIL BLAZER 250 02-06	0410-0162 ¹
XPLORER 250 4X4 01-02	0410-0162 ¹
HAWKEYE 2X4 06-07	0410-0162 ¹
HAWKEYE 4X4 06-07	0410-0162 ¹
MAGNUM 325 2X4/4X4 02	0410-0162 ¹
MAGNUM 325 4X4 HDS 02	0410-0162 ¹
TRAIL BOSS 325 02	0410-0162 ¹
XPEDITION 325 02	0410-0162 ¹
ATP 330 4X4 04-05	0410-0162 ¹
MAGNUM 330 2X4 03-05	0410-0162 ¹
MAGNUM 330 4X4 03-05	0410-0162 ¹
TRAIL BOSS 330 03-07	0410-0162 ¹
SCRAMBLER 400 2X4 01-02	0410-0162 ¹
SCRAMBLER 400 4X4 02	0410-0162 ¹
SPORTSMAN 400 4X4 01-03	0410-0162 ¹
SPORTSMAN 400 4X4 05	0410-0162 ¹
SPORTSMAN 400 4X4 AA AE AG 04	0410-0162 ¹
TRAIL BLAZER 400 03	0410-0162 ¹
XPLORER 400L 4X4 01-02	0410-0162 ¹
XPEDITION 425 01-02	0410-0162 ¹
SPORTSMAN 450 06-07	0410-0162 ¹
ATP 500 4X4 04-05	0410-0162 ¹
MAGNUM 500 4X4 HDS 01-03	0410-0162 ¹
SPORTSMAN 500 4X4 HO 01-03	0410-0162 ¹
SPORTSMAN 500 4X4 HO 05-07	0410-0162 ¹
SPORTSMAN 500 4X4 HO 04	0410-0162 ¹
SPORTSMAN 500 X2 06-07	0410-0162 ¹
SPORTSMAN 500 6X6 01-07	0410-0162 ¹
SPORTSMAN 600 4X4 03-05	0410-0162 ¹
SPORTSMAN 700 4X4 02-07	0410-0162 ¹
SPORTSMAN 800 EFI 05-07	0410-0162 ¹
SPORTSMAN X2 800 EFI 07	0410-0162 ¹
YAMAHA	
YTM225 TRI-MOTO DXK 83-84	0410-0024
YFB250FW TIMBERWOLF 94-00	0410-0073 ¹
YFM350 GRIZZLY IRS 07-11	0410-0073 ¹
YFM350 WARRIOR 88-99	0410-0073 ¹
YFM350 WARRIOR 00-04	0410-0073 ¹
YFM350A BRUIN 2WD 04	0410-0073 ¹
YFM350BA BRUIN 2WD 05-06	0410-0073 ¹
YFM350FA BRUIN 4WD 04-06	0410-0073 ¹
YFM350FEW GRIZZLY 4WD 07-14	0410-0073 ¹
YFM350FW BIG BEAR 87-99	0410-0073 ¹
YFM350GW GRIZZLY 2WD 07-11	0410-0073 ¹
YFM350U BIG BEAR 96-99	0410-0073 ¹
YFM35FX WOLVERINE 95-99	0410-0073 ¹
YFM35FX WOLVERINE 00-05	0410-0073 ¹
YFM35X WOLVERINE 06-09	0410-0073 ¹
YFM400 BIG BEAR 2WD 00-04	0410-0073 ¹
YFM400 BIG BEAR 4WD 00-06	0410-0073 ¹
YFM400 BIG BEAR IRS 07-13	0410-0073 ¹
YFM400 GRIZZLY IRS 07-08	0410-0073 ¹
YFM400 KODIAK 2WD 00-01	0410-0073 ¹
YFM400 KODIAK 2WD 03-04	0410-0073 ¹
YFM400 KODIAK 4WD 93-99	0410-0073 ¹
YFM400 KODIAK 4WD 00-06	0410-0073 ¹
YFM450 GRIZZLY IRS 07-14	0410-0073 ¹
YFM450 KODIAK 03-06	0410-0073 ¹
YFM450 KODIAK 18	0410-0073 ¹
YFM450FX WOLVERINE 4X4 06-10	0410-0073 ¹
YFM550 GRIZZLY 09-14	0410-0073 ¹
YFM600 GRIZZLY 98-02	0410-0073 ¹
YFM660 GRIZZLY 02-08	0410-0073 ¹
YFM700 GRIZZLY 07-17	0410-0073 ¹
YFM700 KODIAK 16-18	0410-0073 ¹

¹ACTUAL BALL BEARING



SWING ARM BEARING KITS

OEM replacement parts designed to rebuild the swing arm to factory specification. Kit contains bearings, seals, spacers and pins.

FITS MODEL	PART #
SWING ARM BEARING KITS	
ARCTIC CAT	
250 2X4 06-09	A28-1056
300 2X4 10-15	A28-1056
HONDA	
TRX200 84	A28-1056
TRX200 90-91	A28-1010
TRX200 96-97	A28-1010
TRX200D 90-97	A28-1010
TRX200SX 86-88	A28-1010
ATC250ES 85-87	A28-1056
ATC250SX 85-87	A28-1056
TRX250 FOURTRAX 85-87	A28-1056
TRX250 RECON 97-17	A28-1056
TRX300 FOURTRAX 300 88-00	A28-1056
TRX350FE/FM/TE/TM 00-06	A28-1056
TRX400FA/FGA 04-07	A28-1056
TRX400FW FOREMAN 4X4 95-03	A28-1056
TRX420 FE/FM 07-17	1302-0303
TRX450ES 98-01	A28-1056
TRX450FE/FM 02-04	A28-1056
TRX450S 98-01	A28-1056
TRX500FPE/FPM FOREMAN 12-13	1302-0303
TRX500FM FOREMAN 14-17	1302-0600
TRX500FA RUBICON 01-13	A28-1056
TRX500FE FOREMAN 05-13	A28-1056
KAWASAKI	
KVF300A PRAIRIE 4X4 99-02	A28-1059
KVF300 BRUTE FORCE 12-16	1302-0619
KVF360A & C PRAIRIE 4X4 03-13	A28-1059
KVF400A PRAIRIE 4X4 97-02	A28-1059
KVF650 BRUTE FORCE 05-13	A28-1059
KVF650 PRAIRIE 02-03	A28-1059
KFX 700 V-FORCE 04-09	A28-1059
KVF700 PRAIRIE 04-06	A28-1059
SUZUKI	
LT-230E 87-93	A28-1085
LT-230S 85-88	A28-1085
LT-250S 89-90	A28-1085
LT-F500F VINSON 03-07	1302-0235
LTV-700F TWIN PEAKS 04-06	A28-1059
YAMAHA	
YFB250FW TIMBERWOLF 92-00	A28-1058
YFM250 BEARTRACKER 99-04	A28-1084
YFM250 BIG BEAR 07-09	A28-1084
YFM250 MOTO-4 89-91	A28-1058
YFM250B BRUIN 05-06	A28-1084
YFM350 WARRIOR 87-04	A28-1027
YFM350ER MOTO-4 87-95	A28-1058
YFM350FW BIG BEAR 87-99	A28-1058
YFM350FX WOLVERINE 95-05	A28-1058
YFM400 BIG BEAR 4WD 00-06	A28-1084
YFM400 KODIAK 4WD 93-99	A28-1058
YFM600 GRIZZLY 98-01	A28-1058

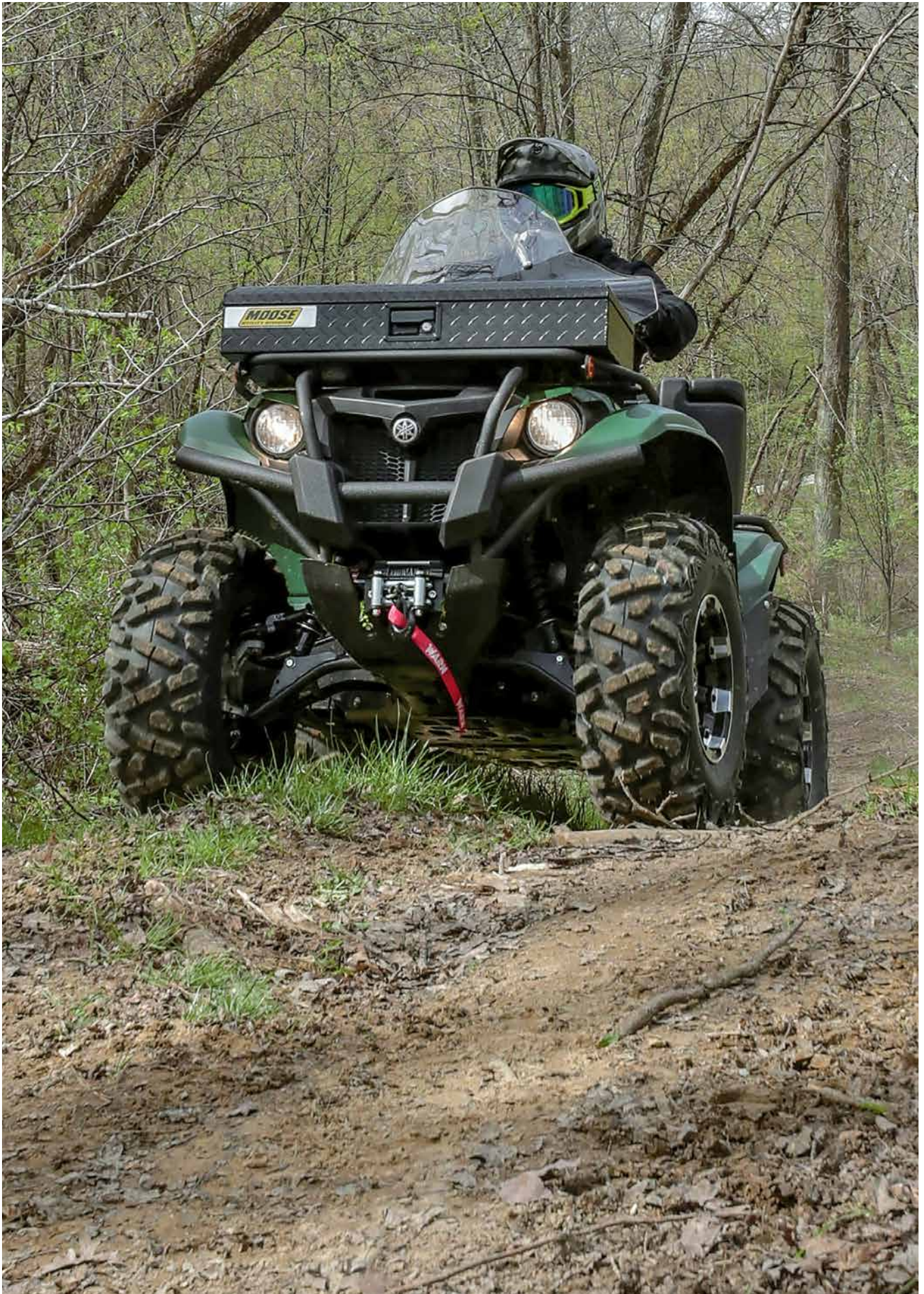

PLOWS

WINCHES

UTV

RACKS

IMPLEMENTS
& TOWING

LUGGAGE

BODY

CONTROLS

ELECTRICAL

WHEELS
& TIRES

SUSPENSION
& DRIVE

BRAKING

ENGINE

RIDER

GARAGE

PROMO

SUSPENSION & DRIVE



PROPELLER SHAFTS

Direct replacement for the OEM shafts. Heat-treated carbon steel. Long lasting operation. Vibration-free design. Direct OEM replacement. Powder-coated black for extreme durability. Heavy-duty U-joints with greased fittings. Replaceable U-joints.

FITS MODEL	POSITION	PART #
PROPELLER SHAFTS		
CAN-AM		
FOR OUTLANDER 500		
STD/XT 4X4 08	R	1205-0313
EFI STD/DPS/XT 4X4 13-14	R	1205-0307
EFI 4X4 15	R	1205-0307
L 500 EFI 4X4 15	R	1205-0307
FOR OUTLANDER MAX 500		
STD/XT 4X4 06-11	R	1205-0314
EFI STD/DPS/XT 4X4 13-14	R	1205-0308
EFI 4X4 15	R	1205-0308
L MAX 500 EFI 4X4 15	R	1205-0308
FOR RENEGADE 500		
EFI 4X4 15	R	1205-0307
EFI STD 4X4 13-14	R	1205-0307
STD 4X4 08	R	1205-0313
FOR OUTLANDER 650		
STD/XT 4X4 08	R	1205-0313
EFI STD/DPS/XT 4X4 13-14	R	1205-0307
EFI XMR 4X4 13-15	R	1205-0307
EFI 4X4 15	R	1205-0307
EFI 6X6 15	R	1205-0308
EFI 6X6 15-17	R-MIDDLE	1205-0305
FOR OUTLANDER MAX 650		
STD/XT 4X4 06-11	R	1205-0314
EFI STD/DPS/XT 4X4 13	R	1205-0308
EFI STD/DPS/XT-P 4X4 14	R	1205-0308
EFI 4X4 15	R	1205-0308
FOR COMMANDER 800		
800R EFI STD/DPS/XT 4X4 13	R	1205-0304
STD/DPS/XT 4X4 14	R	1205-0311
STD/DPS/XT 4X4 15	R	1205-0311
FOR OUTLANDER 800		
STD/XT 4X4 08	R	1205-0313
800R EFI 4X4 15	R	1205-0307
800R EFI STD/DPS/XT/XT-P 4X4 13-14	R	1205-0307
OUTLANDER MAX 800		
STD/XT 4X4 06-10	R	1205-0314
800R EFI DPS/XT/XT-P 4X4 13-14	R	1205-0308
800R EFI 4X4 15	R	1205-0308
FOR RENEGADE 800		
800R EFI 4X4 15	R	1205-0307
800R EFI STD/XXC 4X4 13-14	R	1205-0307
STD/X 4X4 08	R	1205-0313
FOR COMMANDER 1000		
LTD 4X4 13	R	1205-0304
LTD 4X4 14-15	R	1205-0311
STD/DPS/XT/XTP 4X4 14-15	R	1205-0311
MAX 1000 LTD 4X4 15	R	1205-0311
MAX 1000 DPS/XT 4X4 14-15	R	1205-0311
EFI STD/ DPS/ XT/ X 4X4 13	R	1205-0304
FOR MAVERICK 1000		
STD/XRS 4X4 13	R	1205-0312
STD/XRS/XRS-DPS 4X4 14-15	R	1205-0312
XMR 4X4 14-15	R	1205-0312
XXC 4X4 14-15	R	1205-0312
FOR MAVERICK MAX 1000		
STD/ XRS/ XRS-DPS-PART 1 4X4 14	R	1205-0312
STD/ XRS-DPS 4X4 15	R	1205-0312
FOR OUTLANDER 1000		
EFI 4X4 15	R	1205-0307
EFI DPS/XT/XT-P 4X4 13-14	R	1205-0305
EFI XMR 4X4 13-14	R	1205-0310
EFI 6X6 15	R	1205-0308
EFI 6X6 15-17	R-MIDDLE	1205-0305
FOR OUTLANDER MAX 1000		
EFI DPS/XT/XT-P 4X4 13-14	R	1205-0306
EFI LTD 4X4 13-15	R	1205-0306
EFI 4X4 15	R	1205-0308

FITS MODEL	POSITION	PART #
PROPELLER SHAFTS (CON'T)		
CAN-AM (CON'T)		
FOR RENEGADE 1000		
EFI 4X4 15	R	1205-0307
EFI STD/XXC 4X4 13-14	R	1205-0305
POLARIS		
FOR BRUTUS HD HDPTO		
D142M9JDJ/119JDJ/109JDJ/2D9JDJ 4X4 14	F	1205-0298
FOR MILITARY RANGER RZR		
S/SW-M13VE76AA/AD 4X4 13	F	1205-0288
SW-M12VE76AA/AD 4X4 12	F	1205-0288
FOR MILITARY RZR		
SW 800 EFI-M11VE76AA 4X4 11	F	1205-0288
FOR RANGER 570		
570-R16RMA57A1/A4/A9/L1/E57AS/A9/H57AR 4X4 16	F	1205-0289
570 EFI CREW-R17RNA57A1/A9/EAM/NM 4X4 17	F	1205-0292
570 EPS HDPE-R17RMH57A4 4X4 17	F	1205-0289
570 EU-R16RMA57F1/N1/EFH/SF1/2N1 4X4 16	F	1205-0289
CREW 570-6-R16RDA57A1/B1 4X4 16	R	1205-0301
EFI-R14RH57AA/AC/AR/6EAZ 4X4 14	F	1205-0289
EFI CREW-R16RNA57A1/A9/A4/EAH 4X4 16	F	1205-0292
	R	1205-0301
EFI FULL SIZE CREW-R15RUA57AA/E57AC 4X4 15	F	1205-0290
	R	1205-0291
EFI MID SIZE CREW-R15RNA57AA/AC/AR/E57AS 4X4 15	F	1205-0292
	R	1205-0301
FULL SIZE CREW-R16RVA57A1/B1/E57A9/B9 4X4 16	F	1205-0290
	R	1205-0291
INTL-R14RH57FX 4X4 14	F	1205-0289
MID SIZE-R15RMA57AA/AR/AZ/AC/ER 4X4 15	F	1205-0289
FOR RANGER 900 CREW		
6P SP-R17RVA87A1/B1/E87A9/B9 4X4 17	F	1205-0290
	R	1205-0291
6P SP-R17RVA87A1/E87A9 4X4 17	F	1205-0290
	R	1205-0291
ALL OPTIONS-R14WH88A/9EA 4X4 14	F	1205-0290
	R	1205-0291
ALL OPTIONS-R15RUA87/E87 4X4 15	F	1205-0290
	R	1205-0291
ALL OPTIONS-R16RUA/RUE/RVA/RVE 4X4 16	F	1205-0290
	R	1205-0291
FOR RANGER 1000		
CREW 1000XP 6P,PS,NB,MD-R17RVE99NY 4X4 17	F	1205-0290
	R	1205-0291
CREW 1000XP PS ALL OPTIONS-R17RV 99 4X4 17	F	1205-0290
	R	1205-0291
CREW 1000XP PS -		
R17RVA99A1/E99A9/E99AS/E99AV/M99AM/U99AV 4X4 17	F	1205-0290
	R	1205-0291
DIESEL-R16RTAD1A1/ED1E1 4X4 16	F	1205-0298
DIESEL CREW-R15RUA10A 4X4 15	F	1205-0290
	R	1205-0291
DIESEL CREW-R16RVAD1A1 4X4 16	F	1205-0290
	R	1205-0291
DIESEL CREW-R17RVAD1A1 4X4 17	F	1205-0290
	R	1205-0291
DIESEL CREW MD POL-R17RVAD1N1 4X4 17	F	1205-0290
	R	1205-0291
FOR RANGER ETX		
R16RMA32A1/A2 4X4 16	F	1205-0297
R15RMA32AA/AJ 4X4 15	F	1205-0297
EU-R15RMA32FA 4X4 15	F	1205-0297
FOR RANGER HST		
DIESEL DELUXE-R141D9JDA/2D9JDA 4X4 14	F	1205-0298
R151DPD1AA/2D 4X4 15	F	1205-0298
R16B1PD1AA/2P 4X4 16	F	1205-0298
R17B1PD1AA/2P 4X4 17	F	1205-0298
FOR RZR 800		
800-Z14VH76AC/AD/EAL/EAK/EAL/EAW 4X4 2014	F	1205-0288
800 EFI-R08VH76AD/AG 4X4 08	F	1205-0288
800 EFI-R13VH76AC/AD/AN/AS/EAI 4X4 13	F	1205-0288
800 EFI ALL OPTIONS-R09VH76 4X4 09	F	1205-0288
800 EFI ALL OPTIONS-R10VH76/VY76A 4X4 10	F	1205-0288
800 EFI ALL OPTIONS-R11VH76/VY76 4X4 11	F	1205-0288
800 EFI/EPS-R12VH76AB/AD/AF/AH/AI/AJ 4X4 12	F	1205-0288
FOR RZR S 800		
EFI-R09VH76AX 4X4 2009	F	1205-0288
EFI-R10VH76AB/AQ/AW 4X4 10	F	1205-0288

FITS MODEL	POSITION	PART #
PROPELLER SHAFTS (CON'T)		
POLARIS (CON'T)		
FOR RZR S 800 (CON'T)		
EFI-R11VE76AC/AD/AT/AW/AZ 4X4 11	F	1205-0288
EFI-R12VE76AB/AD/AE/AJ/AO 4X4 12	F	1205-0288
EFI-R13VE76AD/AI/AW/7EAS 4X4 13	F	1205-0288
EFI INTL-R09VH76FX 4X4 09	F	1205-0288
EFI INTL-R10VH76FX 4X4 10	F	1205-0288
EFI INTL/ISRAEL-R13VE76FX/FI 4X4 13	F	1205-0288
EFI INTL/ISRAEL-Z14VE76FX/FI 4X4 14	F	1205-0288
EPS INTL-R11VM76FX 4X4 11	F	1205-0288
INTL/ISRAEL-R12VE76FX/FI 4X4 12	F	1205-0288
Z14VE76AD/7EAL/7EAW/7EAJ 4X4 14	F	1205-0288
FOR RZR 900		
50 INCH ALL OPTIONS-Z15VAA87/E87 4X4 15	F	1205-0296
60 INCH ALL OPTIONS-Z15VBA87AJ/E87AK/AM/AT 4X4 15	F	1205-0296
R11JH87AA/AD 4X4 11	F	1205-0299
R12JT87AB/AD/AS/AW/9EAW/R12JT9EFX 4X4 12	F	1205-0299
R13JT87AD/AL/9EAK/EAL/EAO/R13JT9EFX 4X4 13	F	1205-0299
Z14JT87AD/9EAO/9EAO1/9EAL/Z14JT9EFX 4X4 14	F	1205-0299
FOR RZR 4 900		
4-R12XT87AA/9EAS 4X4 12	F	1205-0300
4-R13XT9EFX/R13XT9EAL/R13XT87AA/9EAK 4X4 13	F	1205-0300
4-Z14XT9EAO/Z14XT9EFX 4X4 14	F	1205-0300
4-Z15VCE87AT/AV 4X4 15	F	1205-0294
4 (R07)-Z16VCE87AB/AR/AE/AS 4X4 16	F	1205-0294
FOR RZR XP 1000		
(R06)-Z16VDE99AF/AM/LM/M99AM 4X4 16	F	1205-0302
	R	1205-0295
EU/MD (R03)-Z16VDE99FM/NM 4X4 16	F	1205-0302
	R	1205-0295
INTL-Z15VDE99FV 4X4 15	F	1205-0302
	R	1205-0295
Z15VDE99AT/AL/AV/AW/AA 4X4 15	F	1205-0302
	R	1205-0295
FOR RZR XP 4 1000		
4 1000-Z15VFE99AT/AV/AP 4X4 15	F	1205-0294
	R	1205-0295
4 1000 (R07)-Z16VFE99AF/AS/AM/M99AM 4X4 16	F	1205-0294
	R	1205-0295
4 1000/PS-Z146T1EAM/EAW 4X4 14	F	1205-0294
	R	1205-0295
FOR SPORTSMAN ACE		
ACE-A14BH33AJ 4X4 14	F	1205-0293
ACE 325 EFI-A15DAA32AA/AJ 4X4 15	F	1205-0293
ACE 325 EURO-A15DAA32EA/EJ 4X4 15	F	1205-0293
ACE 325 HD-A15DAH32EJ 4X4 15	F	1205-0293
ACE 570 EFI-A15DAA57AJ/AH 4X4 15	F	1205-0293
ACE 570 EURO-A15DAA57EJ/EH 4X4 15	F	1205-0293
ACE EURO-A14BH33FJ 4X4 14	F	1205-0293
YAMAHA		
FOR GRIZZLY 660		
GRIZZLY 660 (ALL) 4X4 03-08	F	1205-0303



ELECTRIC POWER STEERING KITS

Housing is weather sealed to an IP67 submersion rating and has waterproof connectors. The injection-molded design allows for the EPS to be moisture, debris and vibration resistance. UTV applications come with an adjustable shaft to fine-tune for a perfect fit. No drilling is required for installation.

FITS MODEL	PART #
ELECTRIC POWER STEERING KITS	
CAN-AM	
COMMANDER 800/1000 11-14	0450-0399
MAVERICK 1000 12-15	0450-0400
HONDA	
BIG RED 09-18	0450-0401
PIONEER 500 15-18	0450-0402
PIONEER 700 14-18	0450-0528
KAWASAKI	
TERYX 750 08-13	0450-0403 ¹
POLARIS	
RANGER MID SIZE 400 11-14	0450-0529
RANGER CREW 500 08-09	0450-0407
RANGER CREW 500 10-13	0450-0529
RANGER MID SIZE 500 11-13	0450-0529
RANGER XP 500 11-14	0450-0406
RANGER XP 500 09-10	0450-0405
RANGER XP 500 05-08	0450-0407
RANGER 570 15-16 (FULL SIZE)	0450-0408
RANGER CREW 570 15-16	0450-0408
RZR 570 12-17	0450-0410
RANGER 700 09	0450-0405
RANGER CREW 700 08-09	0450-0407
RANGER XP 700 09	0450-0407 ²
RANGER XP 700 05-08	0450-0407
RANGER MID SIZE 800 11-13	0450-0529
RANGER XP 800 11-14	0450-0406
RANGER 800 11-14 6X6	0450-0406
RANGER CREW 800 10	0450-0405
RANGER CREW 800 11-14	0450-0406
RANGER XP 800 10	0450-0405
RZR 800 09-14	0450-0410
RZR 800 08	0450-0412
RZR S 800 09-14	0450-0410
RZR 4 800 10-14	0450-0410
RANGER CREW 900 13-16	0450-0408
RANGER XP 900 13-17 (GAS)	0450-0408
RANGER XP 900 12-14 (DIESEL)	0450-0406
RZR XP 900 11-14	0450-0411
RZR XP 900 4 12-18	0450-0411
RZR 900/900XC 15-16	0450-0530
RZR 900 S 15-18	0450-0530
RANGER 1000 16-17 DIESEL	0450-0408
RANGER XP 1000 17	0450-0408
RZR 1000 S 16-18	0450-0530
YAMAHA	
RHINO 450 04-14	0450-0409
RHINO 660 04-14	0450-0409
RHINO 700 04-14	0450-0409

¹ WILL NOT FIT VEHICLE WITH DUAL CUP HOLDER EQUIPPED.

² WITH PARKING BRAKE ON THE RIGHT SIDE OF STEERING WHEEL

SUSPENSION & DRIVE

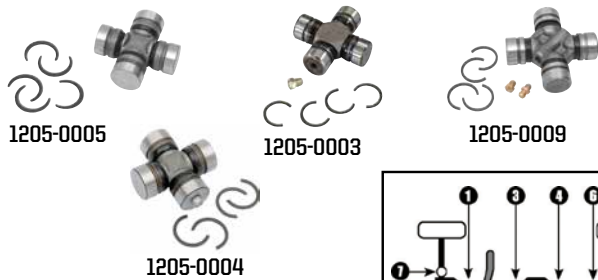

HEAVY-DUTY U-JOINTS
Heavy-duty construction.

U-JOINT FIGURE DIAGRAMS

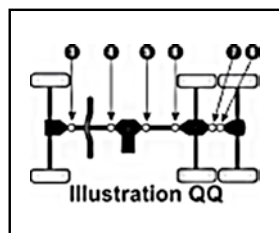
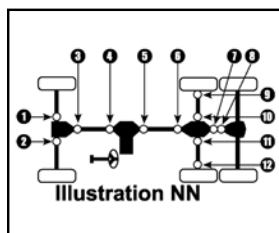
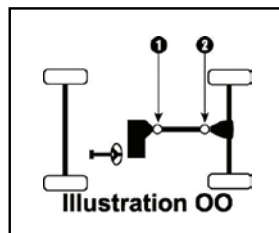
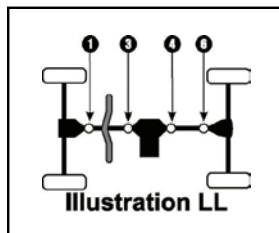
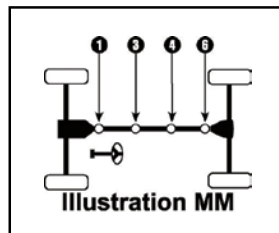
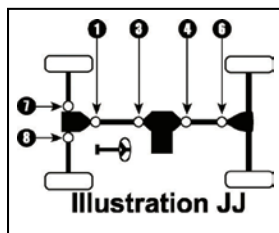
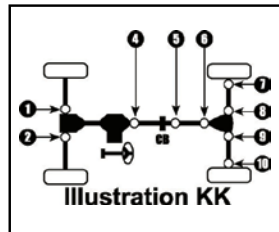
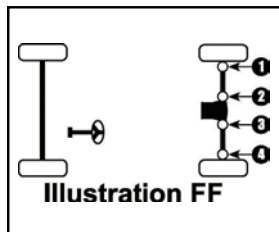
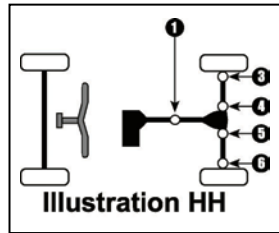
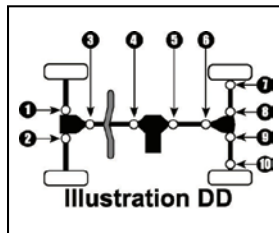
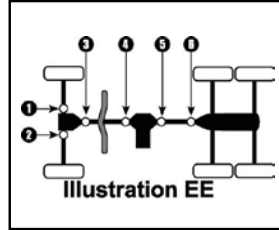
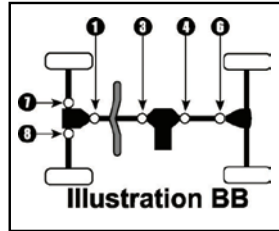
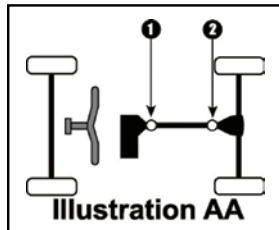

FITS MODEL	FIGURE	LOCATION	PART #
HEAVY-DUTY U-JOINTS			
ARCTIC CAT			
375 02 4X4	BB	1	1205-0179
400 07-08 4X4	BB	1	1205-0179
400 05-06 4X4-EXC. VALUE PACKAGE	BB	1	1205-0179
400 05-06 4X4-VALUE PACKAGE	BB	1,3	1205-0179
400 03-04 4X4	BB	1	1205-0179
500 03-08 4X4	BB	1	1205-0179
650 07-08 4X4-SECONDARY DRIVE SHAFT	BB	4	1205-0179
650 05-06 4X4 H1-SECONDARY DRIVE SHAFT	BB	4	1205-0179
650 05-06 4X4 V2-REAR DRIVE SHAFT	BB	4,6	1205-0197
650 05-06 4X4 V2-FRONT DRIVE SHAFT	BB	1,3	1205-0179
650 04 4X4-REAR DRIVE SHAFT	BB	4,6	1205-0197
650 04 4X4-FRONT DRIVE SHAFT	BB	1,3	1205-0179
700 07-08 4X4-FRONT DRIVE SHAFT	BB	1,3	1205-0179
650 PROWLER XT 07-08 4X4-REAR DRIVE SHAFT	MM	6	1205-0197
650 PROWLER XT 07-08 4X4-SECONDARY DRIVE SHAFT	MM	4	1205-0197
650 PROWLER XT 06 4X4-SECONDARY DRIVE SHAFT	MM	3	1205-0179
650 PROWLER XT 06 4X4-SECONDARY DRIVE SHAFT	MM	4	1205-0197
650 PROWLER XT 06 4X4-REAR DRIVE SHAFT	MM	6	1205-0197
650 PROWLER XT 06 4X4-FRONT DRIVE SHAFT	MM	1	1205-0179
CAN-AM			
OUTLANDER 330 04-05 4WD	LL	4,6	1205-0194
OUTLANDER 330 04-05 2WD	AA	1,2	1205-0194
OUTLANDER 400 06-07 4WD	LL	4,6	1205-0194
OUTLANDER 400 03-05 2WD	AA	1,2	1205-0194
OUTLANDER 400 03-05 4WD	LL	4,6	1205-0194
OUTLANDER 500 07 4WD	LL	3	1205-0194
OUTLANDER 500 07 4WD	LL	4,6	1205-0195
QUEST 500 04 4WD	LL	4	1205-0194
QUEST 500 02-03 4WD	LL	1,3,4	1205-0194
RENEGADE 500 08 4WD	LL	3	1205-0194
RENEGADE 500 08 4WD	LL	4,6	1205-0195
TRAXTER 99-04 4WD	LL	1,3,4	1205-0194
OUTLANDER 650 06-07 4WD	LL	3	1205-0194
OUTLANDER 650 06-07 4WD	LL	4,6	1205-0195
QUEST 650 04 4WD	LL	4	1205-0195
QUEST 650 02-03 4WD	LL	1,3	1205-0194
QUEST 650 02-03 4WD	LL	4	1205-0195
OUTLANDER 800 06-07 4WD	LL	3	1205-0194
OUTLANDER 800 06-07 4WD	LL	4,6	1205-0195
RENEGADE 800 07-08 4WD	LL	3	1205-0194
RENEGADE 800 07-08 4WD	LL	4,6	1205-0195
OUTLANDER 400 13 2015 4WD	LL	4,6	1205-0263
OUTLANDER L 450 15-16 4WD (REAR SHAFT)	LL	4,6	1205-0264
OUTLANDER 500 13-15 4WD	LL	4,6	1205-0264
OUTLANDER L 500 15 4WD (REAR SHAFT)	LL	4,6	1205-0264
OUTLANDER 650 13-15 4WD	LL	4,6	1205-0264
OUTLANDER 800 15 4WD-EXC. XMR	LL	4,6	1205-0264
OUTLANDER 800 13-14 4WD	LL	4,6	1205-0264
OUTLANDER 1000 13 4WD	LL	4,6	1205-0264
OUTLANDER 1000 14 4WD	LL	4,6	1205-0264
OUTLANDER 1000 14 6X6-(MIDDLE AXLES)	QQ	5,6	1205-0264
OUTLANDER 1000 14 6X6-(REAR AXLES)	QQ	7,8	1205-0264
OUTLANDER 1000 15 4WD-EXC. XMR	LL	4,6	1205-0264
OUTLANDER 1000 15 6X6-(MIDDLE AXLES)	QQ	5,6	1205-0264
OUTLANDER 1000 15 6X6-(REAR AXLES)	QQ	7,8	1205-0264
RENEGADE 1000 13-15 4WD	LL	4,6	1205-0264
RENEGADE 500 13-15 4WD	LL	4,6	1205-0264
RENEGADE 800 13-15 4WD	LL	4,6	1205-0264
COMMANDER 800 13-15 4WD (REAR SHAFT)	JJ	4,6	1205-0264
COMMANDER 800 13-15 4WD (FRONT SHAFT)	JJ	1,3	1205-0263
COMMANDER 1000 13-15 4WD (FRONT SHAFT)	JJ	1,3	1205-0263
COMMANDER 1000 13-15 4WD (REAR SHAFT)	JJ	4,6	1205-0264
COMMANDER (ELECTRIC 9KW) 13-14 4WD (FRONT SHAFT)	JJ	1,3	1205-0263
COMMANDER (ELECTRIC 9KW) 14 4WD (REAR SHAFT)	JJ	4,6	1205-0264
MAVERICK 1000 13-15 4WD (FRONT SHAFT)	JJ	1,3	1205-0263
MAVERICK 1000 13-15 4WD (REAR SHAFT)	JJ	4,6	1205-0264
JOHN DEERE			
GATOR HPX 05-07 4X4-FRONT AXLES	JJ	7,8	1205-0004
KAWASAKI			
BAYOU 300 89-04 4WD-FRONT PROP SHAFT	LL	1,3	1205-0005
PRAIRIE 300 99-02 2WD	AA	2	1205-0153
PRAIRIE 300 99-02 4WD-REAR PROP SHAFT	LL	4	1205-0153
PRAIRIE 300 99-02 4WD-FRONT PROP SHAFT	LL	1,3	1205-0175
PRAIRIE 360 10-12 4WD	LL	4	1205-0180
PRAIRIE 360 03-09 2WD	AA	2	1205-0180
PRAIRIE 360 03-09 4WD	LL	4	1205-0180

FITS MODEL	FIGURE	LOCATION	PART #
HEAVY-DUTY U-JOINTS (CON'T)			
KAWASAKI (CON'T)			
PRAIRIE 400 98-02 2WD	AA	2	1205-0153
PRAIRIE 400 98-02 4WD-FRONT PROP SHAFT	LL	1,3	1205-0175
PRAIRIE 400 98-02 4WD-REAR PROP SHAFT	LL	4	1205-0153
PRAIRIE 400 97 4WD-FRONT PROP SHAFT	LL	1,3	1205-0175
PRAIRIE 400 97 4WD-REAR PROP SHAFT	LL	4	1205-0153
BRUTE FORCE 650 05-13 4WD	LL	4	1205-0180
BRUTE FORCE 650I 06-13 4WD	DD	5,6	1205-0180
PRAIRIE 650 02-03 4WD	LL	4	1205-0180
KFX 700 04-09 2WD	AA	2	1205-0180
PRAIRIE 700 04-06 4WD	LL	4	1205-0180
BRUTE FORCE 750I 05-11 4WD	DD	5,6	1205-0180
TERYX 750 08-12 4WD-REAR PROP SHAFT	LL	4,6	1205-0130
TERYX 750 08-12 4WD-FRONT PROP SHAFT	LL	1,3	1205-0153
MULE 1000 88 2WD-450CC	KK	7,10	1205-0153
MULE 2500 94-00 2WD-620CC	KK	7,8,9,10	1205-0130
MULE 2510 00-02 4WD-620CC & 950CC DIESEL-REAR AXLES	KK	7,8,9,10	1205-0130
MULE 2510 00-02 4WD-620CC & 950CC DIESEL-FRONT PROP SHAFT	KK	4,5,6	1205-0153
MULE 2510 93-99 4WD-620CC-FRONT AXLES	KK	1,2	1205-0130
MULE 2510 93-99 4WD-620CC-PROP SHAFT	KK	4,5,6	1205-0005
MULE 2510 93-99 4WD-620CC-REAR AXLES	KK	7,8,9,10	1205-0130
MULE 2520 93-00 2WD-620CC	FF	1,2,3,4	1205-0130
MULE 3000 01-08 2WD-620CC	FF	1,2,3,4	1205-0130
MULE 3010 01-08 4WD-620CC & 950CC DIESEL-PROP SHAFT	KK	4,5,6	1205-0153
MULE 3010 01-08 4WD-620CC & 950CC DIESEL-REAR AXLES	KK	7,8,9,10	1205-0130
MULE 3020 01-03 2WD-620CC	FF	1,2,3,4	1205-0130
MULE 4000 09-12 2WD-620CC	FF	1,2,3,4	1205-0130
MULE 4010 09-12 4WD-620CC & 950CC DIESEL-PROP SHAFT	KK	4,5,6	1205-0153
MULE 4010 09-12 4WD-620CC & 950CC DIESEL-REAR AXLES	KK	7,8,9,10	1205-0130
MULE 610 05-12 4WD-400CC-FRONT PROP SHAFT	DD	3,4	1205-0153
MULE 610 05-12 4WD-400CC-REAR PROP SHAFT	DD	5,6	1205-0153
KUBOTA			
RTV900 03-08 4WD-REAR AXLES	DD	7,8,9,10	1205-0198
POLARIS (CON'T)			
250 90 4X4	BB	7,8	1205-0004
250 93 4X4	BB	7,8	1205-0004
250 93 6X6	EE	1,2	1205-0004
BIG BOSS 250 91-92 6X6	EE	1,2	1205-0004
TRAIL BOSS 250 87-92 4X4	BB	7,8	1205-0004
XPLORER 250 00-02 4X4-FRONT AXLES	BB	7,8	1205-0004
XPLORER 250 00-02 4X4-PROP SHAFT	BB	1,3	1205-0004
300 94 4X4	BB	7,8	1205-0004
300 94 6X6	EE	1,2	1205-0004
SPORTSMAN 300 08-10 4X4-FRONT PROP SHAFT	JJ	1,3	1205-0004
XPLORER 300 96-99 4X4	BB	7,8	1205-0010
MAGNUM 325 00 2X4-REAR PROP SHAFT	AA	1	1205-0004
MAGNUM 325 00 4X4-FRONT AXLES	BB	7,8	1205-0010
MAGNUM 325 00 4X4-FRONT PROP SHAFT	BB	1,3	1205-0004
MAGNUM 325 00 4X4-REAR PROP SHAFT	BB	4	1205-0004
MAGNUM 325 01-02 2X4-REAR PROP SHAFT	AA	1	1205-0004
MAGNUM 325 01-02 4X4-FRONT AXLES-EXC. HDS (VISCO-LOK)	BB	7,8	1205-0010
MAGNUM 325 01-02 4X4-FRONT PROP SHAFT-EXC. HDS (VISCO-LOK)	BB	1,3	1205-0004
MAGNUM 325 01-02 4X4-REAR PROP SHAFT	BB	4	1205-0004
SPORTSMAN ACE 325 15-16 4X4-FRONT PROP SHAFT	BB	1,3	1205-0262
XPEDITION 325 00-02 4X4-FRONT AXLES	DD	1,2	1205-0010
XPEDITION 325 00-02 4X4-FRONT PROP SHAFT	DD	3,4	1205-0004
XPEDITION 325 00-02 4X4-REAR PROP SHAFT	DD	5	1205-0004
ATP 330 04 4X4-FRONT AXLES	BB	7,8	1205-0004
ATP 330 04 4X4-FRONT PROP SHAFT	BB	1,3	1205-0004
ATP 330 04 4X4-REAR PROP SHAFT	BB	4	1205-0010
ATP 330 05 4X4-FRONT PROP SHAFT	BB	1,3	1205-0004
ATP 330 05 4X4-REAR PROP SHAFT	BB	4	1205-0010
MAGNUM 330 03-04 2X4-REAR PROP SHAFT	AA	1	1205-0010
MAGNUM 330 03-04 4X4-FRONT AXLES-EXC. HDS (VISCO-LOK)	BB	7,8	1205-0004
MAGNUM 330 03-04 4X4-FRONT PROP SHAFT	BB	1,3	1205-0004
MAGNUM 330 03-04 4X4-REAR PROP SHAFT	BB	4	1205-0010
MAGNUM 330 05 2X4-REAR PROP SHAFT	AA	1	1205-0010
MAGNUM 330 05 4X4-FRONT PROP SHAFT	BB	1,3	1205-0004
MAGNUM 330 05 4X4-REAR PROP SHAFT	BB	4	1205-0010
MAGNUM 330 06 4X4-FRONT PROP SHAFT	BB	1,3	1205-0004
MAGNUM 330 06 4X4-REAR PROP SHAFT	BB	4	1205-0010
SPORTSMAN 335 99-00 4X4-FRONT AXLES	DD	1,2	1205-0010
SPORTSMAN 335 99-00 4X4-PROP SHAFT	DD	3,4	1205-0004
SPORTSMAN 335 99-00 4X4-REAR AXLES	DD	7,10	1205-0007
SPORTSMAN 335 99-00 4X4-REAR AXLES	DD	8,9	1205-0009
300 96 4X4	BB	7,8	1205-0004

FITS MODEL	FIGURE	LOCATION	PART #
HEAVY-DUTY U-JOINTS (CON'T)			
POLARIS (CON'T)			
350L 90 4X4	BB	7,8	1205-0004
350L 93 4X4	BB	7,8	1205-0004
350L 93 6X6	EE	1,2	1205-0004
TRAIL BOSS 350L 90-92 4X4	BB	7,8	1205-0004
400 94 4X4	BB	7,8	1205-0004
400 94 6X6	EE	1,2	1205-0004
400 95 6X6-W/ INSIDE LOCK RINGS	EE	1,2	1205-0004
400 95 6X6-W/ OUTSIDE LOCK RINGS	EE	1,2	1205-0010
BIG BOSS 400L 97 6X6	EE	1,2	1205-0010
SCRAMBLER 400 95-97 4X4-W/ INSIDE LOCK RINGS	BB	7,8	1205-0004
SCRAMBLER 400 95-97 4X4-W/ OUTSIDE LOCK RINGS	BB	7,8	1205-0010
SCRAMBLER 400 98-02 4X4-FRONT AXLE-W/ INSIDE LOCK RINGS	BB	7,8	1205-0004
SCRAMBLER 400 98-02 4X4-FRONT AXLE-W/ OUTSIDE LOCK RINGS	BB	7,8	1205-0010
SCRAMBLER 400 98-02 4X4-PROP SHAFT	BB	1,3	1205-0004
SPORTSMAN 400 01 4X4-FRONT AXLES	BB	7,8	1205-0010
SPORTSMAN 400 01 4X4-PROP SHAFT	BB	1,3	1205-0004
SPORTSMAN 400 02-04 4X4-FRONT AXLES	BB	7,8	1205-0004
SPORTSMAN 400 02-04 4X4-PROP SHAFT	BB	1,3	1205-0004
SPORTSMAN 400 05 4X4-PROP SHAFT	BB	1,3	1205-0004
SPORTSMAN 400 08-10 4X4-PROP SHAFT	BB	1,3	1205-0004
SPORTSMAN 400 08-14 4X4-PROP SHAFT	BB	1,3	1205-0004
SPORTSMAN 400 93-94 4X4	BB	7,8	1205-0004
SPORTSMAN 400 95-96 4X4-W/ INSIDE LOCK RINGS	BB	7,8	1205-0004
SPORTSMAN 400 95-96 4X4-W/ OUTSIDE LOCK RINGS	BB	7,8	1205-0010
SPORTSMAN 400 97 4X4	BB	7,8	1205-0010
XPLORER 400 95-96 4X4-W/ INSIDE LOCK RINGS	BB	7,8	1205-0004
XPLORER 400 95-96 4X4-W/ OUTSIDE LOCK RINGS	BB	7,8	1205-0010
XPLORER 400 97-98 4X4	BB	7,8	1205-0010
XPLORER 400 99-02 4X4-FRONT AXLES	BB	7,8	1205-0004
XPLORER 400 99-02 4X4-PROP SHAFT	BB	1,3	1205-0004
MAGNUM 425 95 4X4-W/ INSIDE LOCK RINGS	BB	7,8	1205-0004
MAGNUM 425 95 4X4-W/ OUTSIDE LOCK RINGS	BB	7,8	1205-0010
MAGNUM 425 96 4X4-W/ INSIDE LOCK RINGS	BB	7,8	1205-0004
MAGNUM 425 96 4X4-W/ OUTSIDE LOCK RINGS	BB	7,8	1205-0010
MAGNUM 425 96 6X6-W/ INSIDE LOCK RINGS	EE	1,2	1205-0004
MAGNUM 425 96 6X6-W/ OUTSIDE LOCK RINGS	EE	1,2	1205-0010
MAGNUM 425 97 4X4	BB	7,8	1205-0010
MAGNUM 425 97 6X6	EE	1,2	1205-0010
MAGNUM 425 98 4X4	BB	7,8	1205-0010
XPEDITION 425 00-01 4X4-FRONT AXLES	DD	1,2	1205-0010
XPEDITION 425 00-01 4X4-FRONT PROP SHAFT	DD	3,4	1205-0004
XPEDITION 425 00-01 4X4-REAR PROP SHAFT	DD	5	1205-0004
XPEDITION 425 02 4X4-FRONT AXLES	DD	1,2	1205-0004
XPEDITION 425 02 4X4-FRONT PROP SHAFT	DD	3,4	1205-0004
XPEDITION 425 02 4X4-REAR PROP SHAFT	DD	5	1205-0004
SPORTSMAN 450 06-07 4X4	BB	1,3	1205-0004
SPORTSMAN 450 16 4X4-FRONT PROP SHAFT	LL	1,3	1205-0004
DIESEL 455 00 4X4-FRONT AXLES	DD	1,2	1205-0010
DIESEL 455 01 4X4-FRONT AXLES-W/ INSIDE LOCK RINGS	DD	1,2	1205-0004
DIESEL 455 01 4X4-FRONT AXLES-W/ OUTSIDE LOCK RINGS	DD	1,2	1205-0010
DIESEL 455 01 4X4-PROP SHAFT-FRONT 12/07/00	DD	3,4	1205-0004
DIESEL 455 99 4X4-FRONT AXLES	DD	1,2	1205-0010
DIESEL 455 99 4X4-PROP SHAFT	DD	3,4	1205-0004
DIESEL 455 99 4X4-REAR AXLES	DD	7,10	1205-0007
DIESEL 455 99 4X4-REAR AXLES	DD	8,9	1205-0009
ATV 500 H.O. 04 4X4-FRONT AXLES	BB	7,8	1205-0004
ATV 500 H.O. 04 4X4-FRONT PROP SHAFT	BB	1,3	1205-0004
ATV 500 H.O. 04 4X4-REAR PROP SHAFT	BB	4	1205-0010
ATV 500 H.O. 05 4X4-FRONT PROP SHAFT	BB	1,3	1205-0004
ATV 500 H.O. 05 4X4-REAR PROP SHAFT	BB	4	1205-0010
ATV PRO 500 02 4X4-FRONT PROP SHAFT	BB	1,3	1205-0004
ATV PRO 500 02 4X4-REAR PROP SHAFT	BB	4	1205-0004
BIG BOSS 500 98-99 6X6	EE	1,2	1205-0010
MAGNUM 500 01 4X4-FRONT AXLES-EXC. HDS (VISCO-LOK)	BB	7,8	1205-0010
MAGNUM 500 01 4X4-FRONT PROP SHAFT-EXC. HDS (VISCO-LOK)	BB	1,3	1205-0004
MAGNUM 500 01 4X4-REAR PROP SHAFT	BB	4	1205-0004
MAGNUM 500 02 4X4-FRONT AXLES-EXC. HDS (VISCO-LOK)	BB	7,8	1205-0010
MAGNUM 500 02 4X4-FRONT PROP SHAFT	BB	1,3	1205-0004
MAGNUM 500 02 4X4-REAR PROP SHAFT	BB	4	1205-0004
MAGNUM 500 03 4X4-FRONT PROP SHAFT	BB	1,3	1205-0004
MAGNUM 500 03 4X4-REAR PROP SHAFT	BB	4	1205-0010
MAGNUM 500 99-00 4X4-FRONT AXLES	BB	7,8	1205-0010
MAGNUM 500 99-00 4X4-FRONT PROP SHAFT	BB	1,3	1205-0004
SCRAMBLER 500 10-12 4X4-PROP SHAFT	BB	1,3	1205-0004
SCRAMBLER 500 10-12 4X4-PROP SHAFT	BB	1,3	1205-0004
SCRAMBLER 500 97 4X4	BB	7,8	1205-0010

PROMO RIDER ENGINE BRAKING SUSPENSION & DRIVE WHEELS & TIRES ELECTRICAL CONTROLS BODY LUGGAGE IMPLEMENTS & TOWING RACKS UTV WINCHES PLOWES

SUSPENSION & DRIVE

FITS MODEL	FIGURE	LOCATION	PART #
HEAVY-DUTY U-JOINTS (CON'T)			
POLARIS (CON'T)			
SCRAMBLER 500 98 4X4-FRONT AXLES	BB	7,8	1205-0010
SCRAMBLER 500 98 4X4-PROP SHAFT	BB	1,3	1205-0004
SCRAMBLER 500 99-09 4X4-FRONT AXLES	BB	7,8	1205-0004
SCRAMBLER 500 99-09 4X4-PROP SHAFT	BB	1,3	1205-0004
SPORTSMAN 500 02-03 4X4-FRONT AXLES	BB	7,8	1205-0004
SPORTSMAN 500 02-03 4X4-PROP SHAFT	BB	1,3	1205-0004
SPORTSMAN 500 02-03 6X6-FRONT AXLES	EE	1,2	1205-0004
SPORTSMAN 500 02-03 6X6-PROP SHAFT	EE	3,4	1205-0004
SPORTSMAN 500 04 4X4-FRONT AXLES	BB	7,8	1205-0004
SPORTSMAN 500 04 4X4-PROP SHAFT-W/ INSIDE LOCK RINGS	BB	1,3	1205-0004
SPORTSMAN 500 04 4X4-PROP SHAFT-W/ OUTSIDE LOCK RINGS	BB	1,3	1205-0010
SPORTSMAN 500 04 6X6-FRONT AXLES	EE	1,2	1205-0004
SPORTSMAN 500 04 6X6-PROP SHAFT	EE	3,4	1205-0004
SPORTSMAN 500 05-08 4X4-PROP SHAFT	BB	1,3	1205-0004
SPORTSMAN 500 05-08 6X6-FRONT AXLES	EE	1,2	1205-0004
SPORTSMAN 500 05-08 6X6-PROP SHAFT	EE	3,4	1205-0004
SPORTSMAN 500 09-10 4X4-PROP SHAFT	BB	1,3	1205-0004
SPORTSMAN 500 09-14 4X4-PROP SHAFT	BB	1,3	1205-0004
SPORTSMAN 500 96 4X4-FRONT AXLES-W/ INSIDE SNAP RINGS	DD	1,2	1205-0004
SPORTSMAN 500 96 4X4-FRONT AXLES-W/ OUTSIDE SNAP RINGS	DD	1,2	1205-0010
SPORTSMAN 500 96 4X4-PROP SHAFT	DD	3,4	1205-0004
SPORTSMAN 500 96 4X4-REAR AXLES	DD	7,10	1205-0007
SPORTSMAN 500 96 4X4-REAR AXLES	DD	8,9	1205-0009
SPORTSMAN 500 97 4X4-FRONT AXLES	DD	1,2	1205-0004
SPORTSMAN 500 97 4X4-PROP SHAFT	DD	3,4	1205-0004
SPORTSMAN 500 97 4X4-REAR AXLES	DD	7,10	1205-0007
SPORTSMAN 500 97 4X4-REAR AXLES	DD	8,9	1205-0009
SPORTSMAN 500 98 4X4-FRONT AXLES	DD	1,2	1205-0010
SPORTSMAN 500 98 4X4-PROP SHAFT	DD	3,4	1205-0004
SPORTSMAN 500 98 4X4-REAR AXLES	DD	7,10	1205-0007
SPORTSMAN 500 98 4X4-REAR AXLES	DD	8,9	1205-0009
SPORTSMAN 500 99-01 4X4-FRONT AXLES	BB	7,8	1205-0010
SPORTSMAN 500 99-01 4X4-PROP SHAFT-W/ INSIDE LOCK RINGS	BB	1,3	1205-0004
SPORTSMAN 500 99-01 4X4-PROP SHAFT-W/ OUTSIDE LOCK RINGS	BB	1,3	1205-0010
SPORTSMAN 500 99-01 6X6-FRONT AXLES	EE	1,2	1205-0010
SPORTSMAN 500 99-01 6X6-PROP SHAFT	EE	3,4	1205-0004
SPORTSMAN X2 500 06-09 4X4-PROP SHAFT	BB	1,3	1205-0004
XPLORER 500 97 4X4-FRONT AXLES	DD	1,2	1205-0004
XPLORER 500 97 4X4-PROP SHAFT	DD	3,4	1205-0004
XPLORER 500 97 4X4-REAR AXLES	DD	7,10	1205-0007
XPLORER 500 97 4X4-REAR AXLES	DD	8,9	1205-0009
SPORTSMAN 550 11 4X4-11/23/10 AND AFTER-FRONT PROP SHAFT	BB	1,3	1205-0261
SPORTSMAN 550 12-14 4X4-FRONT PROP SHAFT	BB	1,3	1205-0261
SPORTSMAN 550 12-14 4X4-REAR PROP SHAFT	BB	4,6	1205-0004
SPORTSMAN X2 550 10 4X4-FRONT PROP SHAFT	BB	1,3	1205-0004
SPORTSMAN X2 550 10 4X4-REAR PROP SHAFT	BB	4,6	1205-0004
SPORTSMAN XP 550 09-10 4X4-FRONT PROP SHAFT	BB	1,3	1205-0004
SPORTSMAN XP 550 09-10 4X4-REAR PROP SHAFT	BB	4,6	1205-0004
SPORTSMAN 570 14 4X4-PROP SHAFT	BB	1,3	1205-0004
SPORTSMAN 570 14-16 4X4-PROP SHAFT	BB	1,3	1205-0004
SPORTSMAN ACE 570 15-16 4X4-FRONT PROP SHAFT	BB	1,3	1205-0262
SPORTSMAN 600 03-04 4X4-FRONT AXLES	BB	7,8	1205-0004
SPORTSMAN 600 03-04 4X4-FRONT PROP SHAFT	BB	1,3	1205-0004
SPORTSMAN 600 03-04 4X4-REAR PROP SHAFT	BB	4,6	1205-0004
SPORTSMAN 600 05 4X4-FRONT PROP SHAFT	BB	1,3	1205-0004
SPORTSMAN 600 05 4X4-REAR PROP SHAFT	BB	4,6	1205-0004
SPORTSMAN 700 02-04 4X4-FRONT AXLES	BB	7,8	1205-0004
SPORTSMAN 700 02-04 4X4-FRONT PROP SHAFT	BB	1,3	1205-0004
SPORTSMAN 700 02-04 4X4-REAR PROP SHAFT	BB	4,6	1205-0004
SPORTSMAN 700 05-07 4X4-FRONT PROP SHAFT	BB	1,3	1205-0004
SPORTSMAN 700 05-07 4X4-REAR PROP SHAFT	BB	4,6	1205-0004
SPORTSMAN 800 05-08 4X4-FRONT PROP SHAFT	BB	1,3	1205-0004
SPORTSMAN 800 05-08 4X4-REAR PROP SHAFT	BB	4,6	1205-0004
SPORTSMAN 800 09-14 4X4-FRONT PROP SHAFT	BB	1,3	1205-0004
SPORTSMAN 800 09-14 4X4-REAR PROP SHAFT	BB	4,6	1205-0004
SPORTSMAN 800 09-14 6X6-FRONT PROP SHAFT	BB	1,3	1205-0004
SPORTSMAN 800 09-14 6X6-REAR PROP SHAFT	BB	4,6	1205-0004
SPORTSMAN X2 800 07-09 4X4-PROP SHAFT	BB	1,3	1205-0004
SCRAMBLER 850 13-14 4X4-FRONT PROP SHAFT	BB	1,3	1205-0261
SCRAMBLER 850 13-14 4X4-REAR PROP SHAFT	BB	4,6	1205-0004
SCRAMBLER 850 13-17 4X4-FRONT PROP SHAFT	BB	1,3	1205-0261
SCRAMBLER 850 13-17 4X4-REAR PROP SHAFT	BB	4,6	1205-0004
SPORTSMAN 850 10-14 4X4-FRONT PROP SHAFT	LL	1,3	1205-0004
SPORTSMAN 850 10-14 4X4-REAR PROP SHAFT	LL	4,6	1205-0004
SPORTSMAN 850 11 4X4-FRONT PROP SHAFT-11/23/10 AND AFTER	BB	1,3	1205-0261
SPORTSMAN 850 12-14 4X4-FRONT PROP SHAFT	BB	1,3	1205-0261

FITS MODEL	FIGURE	LOCATION	PART #
HEAVY-DUTY U-JOINTS (CON'T)			
POLARIS (CON'T)			
SPORTSMAN 850 16-17 4X4-FRONT PROP SHAFT-EXC. HL	BB	1,3	1205-0261
SPORTSMAN 850 16-17 4X4-FRONT PROP SHAFT-HL (HIGH LIFTER)	BB	1,3	1205-0004
SPORTSMAN 850 16-17 4X4-REAR PROP SHAFT	BB	4,6	1205-0004
SPORTSMAN XP 850 09-10 4X4-FRONT PROP SHAFT	BB	1,3	1205-0004
SPORTSMAN XP 850 09-10 4X4-REAR PROP SHAFT	BB	4,6	1205-0004
SPORTSMAN ACE 900 16 4X4-FRONT PROP SHAFT	BB	1,3	1205-0262
SCRAMBLER 1000 14 4X4-REAR PROP SHAFT	BB	4,6	1205-0004
SCRAMBLER 1000 14-17 4X4-FRONT PROP SHAFT	BB	1,3	1205-0261
SCRAMBLER 1000 14-17 4X4-REAR PROP SHAFT	BB	4,6	1205-0004
SPORTSMAN 1000 16-17 4X4-FRONT PROP SHAFT-EXC. HL	BB	1,3	1205-0261
SPORTSMAN 1000 16-17 4X4-REAR PROP SHAFT	BB	4,6	1205-0004
RANGER 02 2X4-SERIES 10	OO	1,2	1205-0004
RANGER 02 4X4-SERIES 10-FRONT AXLES	JJ	7,8	1205-0004
RANGER 02 4X4-SERIES 10-FRONT PROP SHAFT	JJ	1,3	1205-0004
RANGER 02 4X4-SERIES 10-REAR PROP SHAFT	JJ	4,6	1205-0004
RANGER 02 6X6-SERIES 10-COUPLER SHAFT	NN	7,8	1205-0004
RANGER 02 6X6-SERIES 10-FRONT AXLES	NN	1,2	1205-0004
RANGER 02 6X6-SERIES 10-FRONT PROP SHAFT	NN	3,4	1205-0004
RANGER 02 6X6-SERIES 10-MIDDLE AXLES	NN	9,10,11,12	1205-0007
RANGER 02 6X6-SERIES 10-REAR PROP SHAFT	NN	6	1205-0004
RANGER 03-04 2X4-SERIES 11	OO	1,2	1205-0004
RANGER 03-04 4X4-SERIES 11-FRONT AXLES	JJ	7,8	1205-0004
RANGER 03-04 4X4-SERIES 11-FRONT PROP SHAFT	JJ	1,3	1205-0004
RANGER 03-04 4X4-SERIES 11-REAR PROP SHAFT	JJ	4,6	1205-0004
RANGER 03-04 6X6-SERIES 11-COUPLER SHAFT	NN	7,8	1205-0004
RANGER 03-04 6X6-SERIES 11-FRONT AXLES	NN	1,2	1205-0004
RANGER 03-04 6X6-SERIES 11-FRONT PROP SHAFT	NN	3,4	1205-0004
RANGER 03-04 6X6-SERIES 11-MIDDLE AXLES	NN	9,10,11,12	1205-0007
RANGER 03-04 6X6-SERIES 11-REAR PROP SHAFT	NN	6	1205-0004
RANGER 99-01 6X6-FRONT AXLES	NN	1,2	1205-0004
RANGER 99-01 6X6-FRONT PROP SHAFT	NN	3,4	1205-0004
RANGER 99-01 6X6-MIDDLE AXLES	NN	9,10,11,12	1205-0007
RANGER 99-01 6X6-REAR PROP SHAFT	NN	6	1205-0004
RANGER ETX 15-16 4X4-FRONT PROP SHAFT	JJ	1,3	1205-0262
RANGER EV (ELECTRIC VEHICLE) 10-16 4X4-FRONT PROP SHAFT	JJ	1,3	1205-0004
RANGER 400 10-13 4X4-FRONT PROP SHAFT	JJ	1,3	1205-0004
RANGER 400 10-14-4X4-FRONT PROP SHAFT	JJ	1,3	1205-0004
RANGER 500 05 2X4	OO	1,2	1205-0004
RANGER 500 05 4X4-FRONT PROP SHAFT	JJ	1,3	1205-0004
RANGER 500 05 4X4-REAR PROP SHAFT	JJ	4,6	1205-0004
RANGER 500 05 6X6-COUPLER SHAFT	NN	7,8	1205-0004
RANGER 500 05 6X6-FRONT AXLES	NN	1,2	1205-0004
RANGER 500 05 6X6-FRONT PROP SHAFT	NN	3,4	1205-0004
RANGER 500 05 6X6-MIDDLE AXLES	NN	9,10,11,12	1205-0007
RANGER 500 05 6X6-REAR PROP SHAFT	NN	5,6	1205-0004
RANGER 500 06-07 2X4	OO	1,2	1205-0004
RANGER 500 06-07 4X4-FRONT PROP SHAFT	JJ	1,3	1205-0004
RANGER 500 06-07 4X4-REAR PROP SHAFT	JJ	4,6	1205-0004
RANGER 500 08-09 2X4	OO	1,2	1205-0004
RANGER 500 08-09 4X4-FRONT PROP SHAFT	JJ	1,3	1205-0004
RANGER 500 08-09 4X4-REAR PROP SHAFT	JJ	4,6	1205-0004
RANGER 500 10 4X4-FRONT PROP SHAFT	JJ	1,3	1205-0004
RANGER 500 11-13 4X4-CREW (FRONT PROP SHAFT)	PP	1,2,3	1205-0004
RANGER 500 11-13 4X4-EXC. CREW (FRONT PROP SHAFT)	JJ	1,3	1205-0004
RANGER 570 14 4X4-CREW (FRONT PROP SHAFT)	PP	1,2,3	1205-0262
RANGER 570 14 4X4-EXC. CREW (FRONT PROP SHAFT)	JJ	1,3	1205-0262
RANGER 570 16 4X4-FRONT PROP SHAFT-CREW	PP	1,2,3	1205-0262
RANGER 570 16 4X4-FRONT PROP SHAFT-EXC. CREW-FULL-SIZE W/137 CM (54") WIDE BED BOX	JJ	1,3	1205-0004
RANGER 570 16 4X4-FRONT PROP SHAFT-EXC. CREW-MID-SIZE W/107 CM (42") WIDE BED BOX	JJ	1,3	1205-0262
RANGER 570 16 4X4-FRONT PROP SHAFT-XP 2 SEATER	JJ	1,3	1205-0004
RANGER 570 16 4X4-FRONT PROP SHAFT-XP 4 SEATER	PP	1,2,3	1205-0262
RANGER 700 06-07 6X6-COUPLER SHAFT	NN	7,8	1205-0004
RANGER 700 06-07 6X6-FRONT PROP SHAFT	NN	3,4	1205-0004
RANGER 700 06-07 6X6-REAR PROP SHAFT	NN	5,6	1205-0004
RANGER 700 08-09 4X4-FRONT PROP SHAFT	JJ	1,3	1205-0004
RANGER 700 08-09 4X4-REAR PROP SHAFT	JJ	4,6	1205-0004
RANGER 700 08-09 6X6-COUPLER SHAFT	NN	7,8	1205-0004
RANGER 700 08-09 6X6-FRONT PROP SHAFT	NN	3,4	1205-0004
RANGER 700 08-09 6X6-REAR PROP SHAFT	NN	5,6	1205-0004
RANGER XP 700 05-09 4X4-FRONT PROP SHAFT	JJ	1,3	1205-0004
RANGER XP 700 05-09 4X4-REAR PROP SHAFT	JJ	4,6	1205-0004
RANGER 800 10-14 4X4-EFI CREW-(PROP SHAFT)	JJ	1,3	1205-0004
RANGER 800 10-14 4X4-EXC. EFI CREW (FRONT SHAFT)	KK	4,5,6	1205-0004
RANGER 800 10-14 6X6-COUPLER SHAFT	NN	7,8	1205-0004

FITS MODEL	FIGURE	LOCATION	PART #
HEAVY-DUTY U-JOINTS (CON'T)			
POLARIS (CON'T)			
RANGER 800 10-14 6X6-FRONT PROP SHAFT	NN	3,4	1205-0004
RANGER 800 10-14 6X6-REAR PROP SHAFT	NN	5,6	1205-0004
RANGER 800 15-16 6X6-COUPLER SHAFT	NN	7,8	1205-0004
RANGER 800 15-16 6X6-FRONT PROP SHAFT	NN	3,4	1205-0004
RANGER 800 15-16 6X6-REAR PROP SHAFT	NN	5,6	1205-0004
RANGER 900 13-14 4X4-DIESEL CREW-FRONT PROP SHAFT	PP	1,2,3	1205-0004
RANGER 900 13-14 4X4-DIESEL CREW-REAR PROP SHAFT	PP	4,6	1205-0004
RANGER 900 13-14 4X4-XP-FRONT PROP SHAFT	JJ	1,3	1205-0004
RANGER 900 13-14 4X4 DIESEL-FRONT PROP SHAFT	PP	1,2,3	1205-0004
RANGER 900 13-14 4X4 DIESEL-REAR PROP SHAFT	PP	4,6	1205-0004
RANGER 900 14 4X4-XP CREW-FRONT PROP SHAFT	PP	1,2,3	1205-0262
RANGER 900 15-16 4X4-CREW-FRONT PROP SHAFT	KK	4,5,6	1205-0262
RANGER 900 15-16 4X4-XP-FRONT PROP SHAFT	JJ	1,3	1205-0004
RANGER 1000 16 4X4-DIESEL-FRONT PROP SHAFT	JJ	1,3	1205-0262
RANGER 1000 16 4X4-DIESEL CREW-FRONT PROP SHAFT	KK	4,5,6	1205-0262
RANGER GENERAL 1000 16 4X4-FRONT PROP SHAFT	KK	4,5,6	1205-0004
RZR 570 12-16 4X4-FRONT PROP SHAFT	JJ	1,3	1205-0004
RZR 800 08 4X4-FRONT PROP SHAFT	JJ	1,3	1205-0194
RZR 800 09 4X4-FRONT PROP SHAFT-"S"			
MODELS-(USE INSIDE SNAP RINGS)	JJ	1,3	1205-0004
RZR 800 09 4X4-FRONT PROP SHAFT-EXC.			
"S" MODELS-(USE OUTSIDE SNAP RINGS)	JJ	1,3	1205-0194
RZR 800 10 4X4-FRONT PROP SHAFT	JJ	1,3	1205-0004
RZR 800 11-14 4X4-4 SEATER-FRONT PROP SHAFT	PP	1,2,3	1205-0004
RZR 800 11-14 4X4-EXC. 4 SEATER-FRONT PROP SHAFT	JJ	1,3	1205-0004
RZR 900 11-14 4X4-FRONT PROP SHAFT	KK	4,5,6	1205-0004
RZR 900 15-16 4X4-FRONT PROP SHAFT	KK	4,5,6	1205-0262
RZR 1000 14 4X4-FRONT PROP SHAFT-4 SEATER	KK	4,5,6	1205-0262
RZR 1000 14 4X4-FRONT PROP SHAFT-EXC. 4 SEATER	KK	4,5,6	1205-0004
RZR 1000 15 4X4-FRONT PROP SHAFT-4 SEATER	KK	4,5,6	1205-0262
RZR 1000 15 4X4-FRONT PROP SHAFT-EXC. 4 SEATER	KK	6	1205-0262
RZR 1000 15 4X4-FRONT PROP SHAFT-EXC. 4 SEATER	KK	4,5	1205-0004
RZR 1000 16 4X4-FRONT PROP SHAFT-EXC. XP	KK	4,5,6	1205-0262
RZR 1000 16 4X4-FRONT PROP SHAFT-XP	KK	6	1205-0262
RZR 1000 16 4X4-FRONT PROP SHAFT-XP	KK	4,5	1205-0004
RZR 1000 16 4X4-FRONT PROP SHAFT-XP 4 SEATER	KK	4,5,6	1205-0262
RZR 1000 16 4X4-FRONT PROP SHAFT-XP TURBO	KK	6	1205-0004
RZR 1000 16 4X4-FRONT PROP SHAFT-XP TURBO	KK	4,5	1205-0004
SUZUKI			
OZARK 250 02-06 2WD	HH	1	1205-0174
QUAD RUNNER 250 02 4WD-REAR AXLES	HH	3,6	1205-0172
QUAD RUNNER 250 02 4WD-REAR AXLES	HH	4,5	1205-0178
QUAD RUNNER 250 02 4WD-SECONDARY DRIVE	HH	1	1205-0174
QUAD RUNNER 250 01 2WD	HH	3,6	1205-0172
QUAD RUNNER 250 01 2WD	HH	4,5	1205-0178
QUAD RUNNER 250 01 4WD-REAR AXLES	HH	3,6	1205-0172
QUAD RUNNER 250 01 4WD-REAR AXLES	HH	4,5	1205-0178
QUAD RUNNER 250 01 4WD-SECONDARY DRIVE	HH	1	1205-0174
QUAD RUNNER 250 95-00 2WD	HH	3,6	1205-0172
QUAD RUNNER 250 95-00 4WD-REAR AXLES	HH	3,6	1205-0172
QUAD RUNNER 250 95-00 4WD-SECONDARY DRIVE	HH	1	1205-0176
QUAD RUNNER 250 94 2WD	HH	3,6	1205-0172
QUAD RUNNER 250 94 2WD	HH	4,5	1205-0169
QUAD RUNNER 250 94 4WD-REAR AXLES	HH	3,6	1205-0172
QUAD RUNNER 250 94 4WD-SECONDARY DRIVE	HH	1	1205-0176
QUAD RUNNER 250 88-93 2WD	HH	3,6	1205-0172
QUAD RUNNER 250 88-93 2WD	HH	4,5	1205-0169
QUAD RUNNER 250 88-93 4WD-REAR AXLES	HH	3,6	1205-0172
QUAD RUNNER 250 88-93 4WD-REAR AXLES	HH	4,5	1205-0169
QUAD RUNNER 250 88-93 4WD-SECONDARY DRIVE	HH	1	1205-0176
QUAD RUNNER 250 87 4WD-REAR AXLES	HH	3,6	1205-0008
QUAD RUNNER 250 87 4WD-REAR AXLES	HH	4,5	1205-0169
QUAD RUNNER 250 87 4WD-SECONDARY DRIVE	HH	1	1205-0176
QUAD SPORT 250 04-06 2WD	HH	1	1205-0174
KING QUAD 300 01-02 4WD-REAR AXLES	HH	3,6	1205-0173
KING QUAD 300 01-02 4WD-REAR AXLES	HH	4,5	1205-0178
KING QUAD 300 01-02 4WD-SECONDARY DRIVE	HH	1	1205-0174
KING QUAD 300 96-00 4WD-REAR AXLES	HH	3,6	1205-0173
KING QUAD 300 96-00 4WD-SECONDARY DRIVE	HH	1	1205-0176
KING QUAD 300 91-93 4WD-REAR AXLES	HH	3,6	1205-0173
KING QUAD 300 91-93 4WD-REAR AXLES	HH	4,5	1205-0169
QUAD RUNNER 300 95 4WD-REAR AXLES	HH	3,6	1205-0173
QUAD RUNNER 300 95 4WD-SECONDARY DRIVE	HH	1	1205-0176
QUAD RUNNER 300 94 4WD-REAR AXLES	HH	3,6	1205-0173
QUAD RUNNER 300 94 4WD-REAR AXLES	HH	4,5	1205-0169
QUAD RUNNER 300 94 4WD-SECONDARY DRIVE	HH	1	1205-0176

FITS MODEL	FIGURE	LOCATION	PART #
HEAVY-DUTY U-JOINTS (CON'T)			
SUZUKI (CON'T)			
EIGER 400 05-06 4WD-FRONT BEVEL GEAR	LL	1	1205-0174
EIGER 400 05-06 4WD-SECONDARY DRIVE	LL	4,6	1205-0174
EIGER 400 02-04 2WD	HH	1	1205-0174
EIGER 400 02-04 4WD-FRONT BEVEL GEAR	LL	1	1205-0174
EIGER 400 02-04 4WD-SECONDARY DRIVE	LL	4,6	1205-0174
KING QUAD 400 10-12 4WD-FRONT BEVEL GEAR	LL	3	1205-0174
KING QUAD 400 10-12 4WD-SECONDARY DRIVE	LL	4,6	1205-0174
QUAD MASTER 500 01 4WD-FRONT BEVEL GEAR	LL	1	1205-0174
QUAD MASTER 500 01 4WD-SECONDARY DRIVE	LL	4,6	1205-0176
QUAD MASTER 500 00 4WD-FRONT BEVEL GEAR	LL	1	1205-0176
QUAD MASTER 500 00 4WD-SECONDARY DRIVE	LL	4	1205-0176
QUAD RUNNER 500 02 4WD-FRONT BEVEL GEAR	LL	1	1205-0174
QUAD RUNNER 500 02 4WD-SECONDARY DRIVE	LL	4,6	1205-0174
QUAD RUNNER 500 01 4WD	LL	4,6	1205-0174
QUAD RUNNER 500 98-00 4WD	LL	4	1205-0176
VINSON 500 02-06 4WD-FRONT BEVEL GEAR	LL	1	1205-0174
VINSON 500 02-06 4WD-SECONDARY DRIVE	LL	4	1205-0176
VINSON 500 02-06 4WD-SECONDARY DRIVE	LL	6	1205-0176
KING QUAD 700 05-06 4WD-SECONDARY DRIVE	LL	6	1205-0176
KING QUAD 750 08-12 4WD-SECONDARY DRIVE	LL	6	1205-0176
TWIN PEAKS 700 04-05 4WD	LL	4	1205-0180
QUV UTILITY 620 05 4WD-FRONT PROP SHAFT	KK	4	1205-0153
QUV UTILITY 620 05 4WD-REAR AXLES	KK	7,8,9,10	1205-0130
QUV UTILITY 620 05 4WD-REAR PROP SHAFT	KK	5,6	1205-0153
YAMAHA			
MOTO-4 225 86-88 2WD	AA	1	1205-0170
MOTO-4 250 89-91 2WD	AA	1	1205-0170
TIMBERWOLF 250 99-00 4WD-FRONT DRIVE SHAFT	LL	1,3	1205-0003
TIMBERWOLF 250 99-00 4WD-REAR DRIVE SHAFT	LL	4	1205-0170
TIMBERWOLF 250 94-98 4WD-FRONT DRIVE SHAFT	LL	1,3	1205-0003
TIMBERWOLF 250 94-98 4WD-REAR DRIVE SHAFT	LL	4	1205-0170
TIMBERWOLF 250 94-98 2WD	AA	1	1205-0170
TIMBERWOLF 250 92-93 2WD	AA	1	1205-0170
BEAR TRACKER 250 99-04 2WD	AA	1	1205-0170
BIG BEAR 250 07-08 2WD	HH	1	1205-0170
BRUIN 250 06 2WD	HH	1	1205-0170
BIG BEAR 350 87-99 4WD-FRONT DRIVE SHAFT	LL	1,3	1205-0003
BIG BEAR 350 87-99 4WD-REAR DRIVE SHAFT	LL	4,6	1205-0006
BIG BEAR 350 86 4WD-FRONT DRIVE SHAFT	LL	1,3	1205-0170
GRIZZLY 350 07-14 4WD-W/O IRS	LL	4	1205-0170
GRIZZLY 350 07-14 2WD	HH	1	1205-0170
GRIZZLY 350 07-14 4WD-W/ IRS-(FRONT DRIVE SHAFT)	LL	1,3	1205-0170
GRIZZLY 350 07-14 4WD-W/ IRS-(REAR DRIVE SHAFT)	LL	4,6	1205-0170
WOLVERINE 350 06-08 2WD	HH	1	1205-0170
WOLVERINE 350 95-98 4WD-FRONT DRIVE SHAFT	LL	1,3	1205-0170
WOLVERINE 350 95-98 4WD-REAR DRIVE SHAFT	LL	4,6	1205-0006
BIG BEAR 400 07-12 4WD-W/ IRS-(FRONT DRIVE SHAFT)	LL	1,3	1205-0170
BIG BEAR 400 07-12 4WD-W/ IRS-(REAR DRIVE SHAFT)	LL	4,6	1205-0170
BIG BEAR 400 06 4WD-FRONT DRIVE SHAFT	LL	1,3	1205-0170
GRIZZLY 400 07-08 4WD-REAR DRIVE SHAFT	LL	4,6	1205-0170
KODIAK 400 05-06 4WD-REAR DRIVE SHAFT	AA	1,2	1205-0170
KODIAK 400 98-99 4WD-FRONT DRIVE SHAFT	LL	1,3	1205-0170
KODIAK 400 93-97 4WD-FRONT DRIVE SHAFT	LL	1,3	1205-0003
KODIAK 400 93-97 4WD-REAR DRIVE SHAFT	LL	4,6	1205-0006
GRIZZLY 450 07-14 4WD-W/ IRS-(FRONT DRIVE SHAFT)	LL	1,3	1205-0170
GRIZZLY 450 07-14 4WD-W/ IRS-(REAR DRIVE SHAFT)	LL	4,6	1205-0170
KODIAK 450 03-06 4WD-REAR DRIVE SHAFT	LL	4,6	1205-0170
KODIAK 450 03-06 4WD-FRONT DRIVE SHAFT	LL	1,3	1205-0170
WOLVERINE 450 07-08 4WD-REAR DRIVE SHAFT	HH	1	1205-0170
GRIZZLY 600 98 4WD-FRONT DRIVE SHAFT	LL	1,3	1205-0003
GRIZZLY 600 98 4WD-REAR DRIVE SHAFT	LL	4,6	1205-0006
RHINO 450 06 4WD-FRONT DRIVE SHAFT	LL	1,3	1205-0170
RHINO 660 04-07 4WD-FRONT DRIVE SHAFT	LL	1,3	1205-0170
RHINO 700 08-09 4WD-FRONT DRIVE SHAFT	LL	1,3	1205-0170

PLOWES
WINCHES
UTV
RACKS
IMPLEMENTES & TOWING
LUGGAGE
BODY
CONTROLS
ELECTRICAL
WHEELS & TIRES
SUSPENSION & DRIVE
BRAKING
ENGINE
RIDER
GARAGE
PROMO





PLOWS

WINCHES

UTV

RACKS

IMPLEMENTS
& TOWING

LUGGAGE

BODY

CONTROLS

ELECTRICAL

WHEELS
& TIRES

SUSPENSION
& DRIVE

BRAKING

ENGINE

RIDER

GARAGE

PROMO

BRAKING

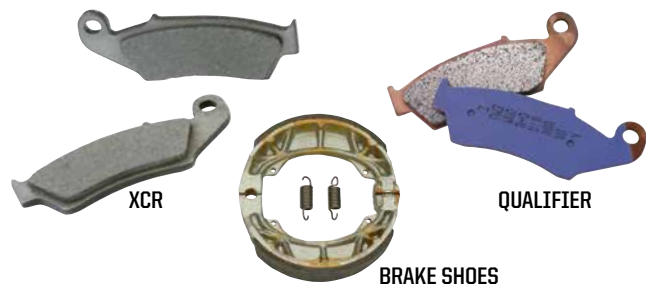

BRAKE PADS & SHOES BY DP BRAKES

Pads are constructed of durable sintered metal which stands up to the toughest conditions and provides equal braking power, wet or dry. Brake shoes are asbestos-free and offer durability and performance.

XCR BRAKE PADS

Ultimate wet condition pads. Low-wear S-47 sintered metal compound outlasts the gnarliest conditions. High-tech gray zirconium-based ceramic applied extra thick to protect brake fluid from heat.

QUALIFIER BRAKE PADS

Latest generation of Kevlar® based organic material. Progressive feel and rider feedback. No rotor wear and quiet.

FITS MODEL	COMPOUND	FRONT PART #	COMPOUND	REAR PART #
BRAKE PADS & SHOES				
ARCTIC CAT/TEXTRON				
ALL DISC BRAKE MODELS (EXCEPT BELOW) 96-04				
	XCR	M914-S47	XCR	M914-S47
	QUALIFIER	1720-0236	QUALIFIER	1720-0236
50 YOUTH 2X4 04-05	XCR	1723-0139	XCR	1723-0133
ALTERRA 90 18-19	XCR	1723-0138	XCR	
90 YOUTH 2X4 02-05	XCR	1723-0139	XCR	1723-0133
250 2X4/4X4 99-04	QUALIFIER	1720-0236	QUALIFIER	1720-0236
	XCR	M914-S47	XCR	M914-S47
250 2X4/4X4 05	QUALIFIER	1720-0232	QUALIFIER	1720-0232
	XCR	1721-0621	XCR	1721-0621
300 4X4 05-16	QUALIFIER	1720-0232	QUALIFIER	1720-0232
	XCR	1721-0621	XCR	1721-0621
300 2X4/4X4 98-04	QUALIFIER	1720-0236	QUALIFIER	1720-0236
	XCR	M914-S47	XCR	M914-S47
350 4X4 12	QUALIFIER	1720-0232	QUALIFIER	1720-0232
	XCR	1721-0621	XCR	1721-0621
366 (AUTO 4X4) 07-11	QUALIFIER	1720-0232	QUALIFIER	1720-0232
	XCR	1721-0621	XCR	1721-0621
400 TRV (2X4/4X4) (2-PASSENGER) 09-13	QUALIFIER	1720-0232	QUALIFIER	1720-0232
	XCR	1721-0621	XCR	1721-0621
400 4X4 UTILITY / LE 05-08, VP / AUTO 06-08	QUALIFIER	1720-0232	QUALIFIER	1720-0232
	XCR	1721-0621	XCR	1721-0621
400 4X4 FIS (MANUAL TRANSMISSION) 05-06 PARKING BRAKE	QUALIFIER	1720-0236	QUALIFIER	-
	XCR	M914-S47	XCR	-
400 4X4 FIS (MANUAL TRANSMISSION) 05-06	QUALIFIER	1720-0232	QUALIFIER	1720-0232
	XCR	1721-0621	XCR	1721-0621
400 2X4/4X4 CORE 13-14	QUALIFIER	1720-0232	QUALIFIER	1720-0232
	XCR	1721-0621	XCR	1721-0621
400 2X4/4X4 ACT/UTILITY/AUTO ALL 98-04	QUALIFIER	1720-0236	QUALIFIER	1720-0236
	XCR	M914-S47	XCR	M914-S47
425I/SE 12	QUALIFIER	1720-0232	QUALIFIER	1720-0232
	XCR	1721-0621	XCR	1721-0621
450I/GT (2 PASSENGER) 11-12	QUALIFIER	1720-0232	QUALIFIER	1720-0232
	XCR	1721-0621	XCR	1721-0621
450 TRV/TRV / XCI 11-18	QUALIFIER	1720-0232	QUALIFIER	1720-0232
	XCR	1721-0621	XCR	1721-0621
450 IXC 11-13	QUALIFIER	1720-0232	QUALIFIER	1720-0232
	XCR	1721-0621	XCR	1721-0621
450 HI EFI 10	QUALIFIER	1720-0232	QUALIFIER	1720-0232
	XCR	1721-0621	XCR	1721-0621
450 2X4/4X4 CORE 13-14	QUALIFIER	1720-0232	QUALIFIER	1720-0232
	XCR	1721-0621	XCR	1721-0621
454 BEARCAT 96-97	QUALIFIER	1720-0236	QUALIFIER	1720-0236
	XCR	M914-S47	XCR	M914-S47

FITS MODEL	COMPOUND	FRONT PART #	COMPOUND	REAR PART #
BRAKE PADS & SHOES (CON'T)				
ARCTIC CAT/TEXTRON (CON'T)				
454 BEARCAT 98	QUALIFIER	1720-0236	QUALIFIER	1720-0236
	XCR	M914-S47	XCR	M914-S47
ALTERRA 500 18-19	XCR	1721-0621	XCR	1721-0621
500 TRV (AUTOMATIC) 03-04	QUALIFIER	1720-0236	QUALIFIER	1720-0236
	XCR	M914-S47	XCR	M914-S47
500 PARKING BRAKE ALL MODELS 06-18	QUALIFIER	-	QUALIFIER	1720-0232
	XCR	-	XCR	1721-0621
500 HDX POWLER / LTD / XT 18-19	XCR	1721-0621	XCR	1721-0621
	QUALIFIER	1720-0232	QUALIFIER	1720-0232
500 FIS (MANUAL AND AUTOMATIC) 05-09 PARKING BRAKE	QUALIFIER	1720-0236	QUALIFIER	-
	XCR	M914-S47	XCR	-
500 FIS (MANUAL AND AUTOMATIC) 05-09	QUALIFIER	1720-0232	QUALIFIER	1720-0232
	XCR	1721-0621	XCR	1721-0621
500 2X4/4X4 (MANUAL) 98-04, (AUTO) 02-04	QUALIFIER	1720-0236	QUALIFIER	1720-0236
	XCR	M914-S47	XCR	M914-S47
500 - ALL MODELS 06-18	QUALIFIER	1720-0232	QUALIFIER	1720-0232
	XCR	1721-0621	XCR	1721-0621
550 TRV HI/GT EFI 2-UP 09-13	QUALIFIER	1720-0232	QUALIFIER	1720-0232
	XCR	1721-0621	XCR	1721-0621
550 PROWLER/XT/LTD 4X4 09-14	XCR	1721-0621	XCR	1721-0621
	QUALIFIER	1720-0232	QUALIFIER	1720-0232
550 LTDI GT/GT TRV/LTD 11-12	QUALIFIER	1720-0232	QUALIFIER	1720-0232
	XCR	1721-0621	XCR	1721-0621
550 HI EFI 09-11	QUALIFIER	1720-0232	QUALIFIER	1720-0232
	XCR	1721-0621	XCR	1721-0621
550 CORE/LTD/XT/TRVXT 13-14	QUALIFIER	1720-0232	QUALIFIER	1720-0232
	XCR	1721-0621	XCR	1721-0621
550 ALTERRA XT 16	QUALIFIER	1720-0232	QUALIFIER	1720-0232
	XCR	1721-0621	XCR	1721-0621
650 XT PROWLER 05-10	QUALIFIER	1720-0232	QUALIFIER	1720-0232
	XCR	1721-0621	XCR	1721-0621
650 V2 (4X4) 04-06	QUALIFIER	1720-0232	QUALIFIER	1720-0232
	XCR	1721-0621	XCR	1721-0621
650 HI TBX/TRV 4X4 AUTO 09-10	QUALIFIER	1720-0232	QUALIFIER	1720-0232
	XCR	1721-0621	XCR	1721-0621
650 (4X4 AUTO/AUTO LE) 04-06 PARKING BRAKE	QUALIFIER	1720-0232	QUALIFIER	-
	XCR	1721-0621	XCR	-
650 (4X4 AUTO/AUTO LE) 04-06	QUALIFIER	1720-0232	QUALIFIER	1720-0232
	XCR	1721-0621	XCR	1721-0621
ALTERRA 700 18-19	QUALIFIER	1720-0232	QUALIFIER	1720-0232
	XCR	1721-0621	XCR	1721-0621
700I XTX PROWLER 11-16	XCR	1721-0621	XCR	1721-0621
	QUALIFIER	1720-0232	QUALIFIER	1720-0232
700I MUD PRO/LTD 11-18	QUALIFIER	1720-0232	QUALIFIER	1720-0232
	XCR	1721-0621	XCR	1721-0621
700I GT/LTD/TBX/MUD PRO LTD 09-18	QUALIFIER	1720-0232	QUALIFIER	1720-0232
	XCR	1721-0621	XCR	1721-0621
700 TBX 10-15	QUALIFIER	1720-0232	QUALIFIER	1720-0232
	XCR	1721-0621	XCR	1721-0621
700 PROWLER HDX / XTX 09-18	XCR	1721-0621	XCR	1721-0621
	QUALIFIER	1720-0232	QUALIFIER	1720-0232
700 CORE/LTD/XT/MUD PRO/DIESEL 13-14	QUALIFIER	1720-0232	QUALIFIER	1720-0232
	XCR	1721-0621	XCR	1721-0621
700 - ALL MODELS PARKING BRAKE 06-18	QUALIFIER	-	QUALIFIER	1720-0232
	XCR	-	XCR	1721-0621
700 4X4 AUTO 06-10	QUALIFIER	1720-0232	QUALIFIER	1720-0232
	XCR	1721-0621	XCR	1721-0621
700 - ALL MODELS INC PROWLER 06-18	QUALIFIER	1720-0232	QUALIFIER	1720-0232
	XCR	1721-0621	XCR	1721-0621
700 WILDCAT 18-19	XCR	1721-0621	XCR	1721-0621
812 PROWLER PRO CREW XT/RANCH EDITION (6 SEAT) 18-19	XCR	1721-2875	XCR	1721-2874
812 PROWLER PRO/HUNTER EDITION (3 SEAT) 18-19	XCR	1721-2875	XCR	1721-2874
850 STAMPEDE 4 18-19	XCR	1721-0621	XCR	1721-0621
	QUALIFIER	1720-0232	QUALIFIER	1720-0232
850 STAMPEDE X/HUNTER EDITION (2 SEAT) 18-19	XCR	1721-2871	XCR	1721-2871

FITS MODEL	COMPOUND	FRONT PART #	COMPOUND	REAR PART #
BRAKE PADS & SHOES (CON'T)				
ARCTIC CAT/TEXTRON (CON'T)				
850 STAMPEDE 4/4X/4 HUNTER EDITION (4SEAT) 18-19	XCR	1721-2871	XCR	1721-2871
850 STAMPEDE FOREST/LTD/XT/XTR (4 SEAT) 17	XCR	1721-2871	XCR	1721-2871
957 HAVOC /X/BACKCOUNTRY EDITION (2 SEAT) 18-19	XCR	1721-2873	XCR	1721-2874
998 WILDCAT XX/XX LTD (2 SEAT) 18-19	XCR	1721-2875	XCR	1721-2874
1000 XTZ/11-18	XCR	1721-0621	XCR	1721-0621
	QUALIFIER	1720-0232	QUALIFIER	1720-0232
1000 XT/MUD PRO LTD 11-18	QUALIFIER	1720-0232	QUALIFIER	1720-0232
	XCR	1721-0621	XCR	1721-0621
1000 WILDCAT/GT/LTD 11-18	XCR	1721-0621	XCR	1721-0621
	QUALIFIER	1720-0232	QUALIFIER	1720-0232
1000 WILDCAT 4/X1000 /LTD 13 - 16	XCR	1721-0621	XCR	1721-0621
	QUALIFIER	1720-0232	QUALIFIER	1720-0232
1000 THUNDERCAT 08-13	QUALIFIER	1720-0232	QUALIFIER	1720-0232
	XCR	1721-0621	XCR	1721-0621
1000 H2 TRV 09-16	QUALIFIER	1720-0232	QUALIFIER	1720-0232
	XCR	1721-0621	XCR	1721-0621
1000 XTZ H2 PROWLER 09-15	XCR	1721-0621	XCR	1721-0621
	QUALIFIER	1720-0232	QUALIFIER	1720-0232
PROWLER EV ELECTRIC EV/EV IS (4 SEAT) 18-19	XCR	1721-2873	XCR	1721-2874
CAN-AM				
200 RALLY 03-08	XCR	M312-S47	XCR	-
330 OUTLANDER/MAX 03-09 (LEFT)	QUALIFIER	1720-0234	QUALIFIER	-
	XCR	M920-S47	XCR	-
330 OUTLANDER/MAX 03-09 (RIGHT)	QUALIFIER	1720-0233	QUALIFIER	1720-0234
	XCR	M919-S47	XCR	M920-S47
400 OUTLANDER EFI 09-13 (LEFT)	QUALIFIER	1720-0234	QUALIFIER	-
	XCR	M920-S47	XCR	-
400 OUTLANDER EFI 09-13 (RIGHT)	QUALIFIER	1720-0233	QUALIFIER	1720-0234
	XCR	M919-S47	XCR	M920-S47
400 OUTLANDER/MAX (STD/XT) 07-14 (LEFT)	QUALIFIER	1720-0234	QUALIFIER	-
	XCR	M920-S47	XCR	-
400 OUTLANDER/MAX (STD/XT) 07-14 (RIGHT)	QUALIFIER	1720-0233	QUALIFIER	1720-0234
	XCR	M919-S47	XCR	M920-S47
450 OUTLANDER L EFI / MAX EFI 15-18 (LEFT)	XCR	1721-1446	XCR	1721-1446
450 OUTLANDER L EFI / MAX EFI 15-18 (RIGHT)	XCR	1721-1445	XCR	1721-1445
500 OUTLANDER 4X4 /MAX STD/DPS/XT 13-15 (LEFT)	XCR	1721-1445	XCR	-
500 OUTLANDER 4X4 /MAX STD/DPS/XT 13-15 (RIGHT)	XCR	1721-1446	XCR	1721-1446
500 OUTLANDER L EFI / MAX EFI 15 (LEFT)	XCR	1721-1446	XCR	1721-1446
500 OUTLANDER L EFI / MAX EFI 15 (RIGHT)	XCR	1721-1445	XCR	1721-1445
500 OUTLANDER STD/DPS/XT 13 (LEFT)	XCR	1721-1445	XCR	1721-1445
500 OUTLANDER STD/DPS/XT 13 (RIGHT)	XCR	1721-1446	XCR	1721-1446
500 OUTLANDER/MAX (STD/XT) 07-12 (LEFT)	QUALIFIER	1720-0234	QUALIFIER	-
	XCR	M920-S47	XCR	-
500 OUTLANDER/MAX (STD/XT) 07-12 (RIGHT)	QUALIFIER	1720-0233	QUALIFIER	1720-0234
	XCR	M919-S47	XCR	M920-S47
500 QUEST 03-05 (LEFT)	QUALIFIER	1720-0233	QUALIFIER	-
	XCR	M919-S47	XCR	-
500 QUEST 03-05 (RIGHT)	QUALIFIER	1720-0234	QUALIFIER	1720-0233
	XCR	M920-S47	XCR	M919-S47
500 RENEGADE (4X4/EFI) 07-15 (LEFT)	QUALIFIER	1720-0234	QUALIFIER	-
	XCR	M920-S47	XCR	-
500 RENEGADE (4X4/EFI) 07-15 (RIGHT)	QUALIFIER	1720-0233	QUALIFIER	1720-0234
	XCR	M919-S47	XCR	M920-S47
500 TRAXTER 01-05 (LEFT)	QUALIFIER	1720-0233	QUALIFIER	1720-0233
	XCR	M919-S47	XCR	M919-S47
500 TRAXTER 01-05 (RIGHT)	QUALIFIER	1720-0234	QUALIFIER	-
	XCR	M920-S47	XCR	-
570 OUTLANDER L/L MAX/ EFI 16-18 (LEFT)	XCR	1721-1445	XCR	-

FITS MODEL	COMPOUND	FRONT PART #	COMPOUND	REAR PART #
BRAKE PADS & SHOES (CON'T)				
CAN-AM (CON'T)				
570 OUTLANDER L/L MAX/ EFI 16-18 (RIGHT)	XCR	1721-1446	XCR	1721-1446
570 RENEGADE EFI 16-19 (LEFT)	XCR	1721-1445	XCR	1721-1446
570 RENEGADE EFI 16-19 (RIGHT)	XCR	1721-1446	XCR	1721-1445
DS650/BAJA/X 01-07 (LEFT) (ALL)	QUALIFIER	1720-0234	QUALIFIER	1720-0234
	XCR	M920-S47	XCR	M920-S47
DS650/BAJA/X 01-07 (RIGHT) (ALL)	QUALIFIER	1720-0233	QUALIFIER	-
	XCR	M919-S47	XCR	-
650 OUTLANDER MAX STD/DPS/XT 13-18 (LEFT)	XCR	1721-1445	XCR	-
650 OUTLANDER MAX STD/DPS/XT 13-18 (RIGHT)	XCR	1721-1446	XCR	1721-1446
650 OUTLANDER MMR 15-18 (LEFT)	XCR	1721-1446	XCR	1721-1446
650 OUTLANDER MMR 15-18 (RIGHT)	XCR	1721-1445	XCR	1721-1445
650 OUTLANDER STD/DPS/XT 13-19 (LEFT)	XCR	1721-1445	XCR	-
650 OUTLANDER STD/DPS/XT 13-19 (RIGHT)	XCR	1721-1446	XCR	1721-1446
650 OUTLANDER/OUTLANDER MAX 06-12 (ALL) (LEFT)	QUALIFIER	1720-0234	QUALIFIER	-
	XCR	M920-S47	XCR	-
650 OUTLANDER/OUTLANDER MAX 06-12 (ALL) (RIGHT)	QUALIFIER	1720-0233	QUALIFIER	1720-0234
	XCR	M919-S47	XCR	M920-S47
650 QUEST 02-05 (LEFT)	QUALIFIER	1720-0233	QUALIFIER	1720-0233
	XCR	M919-S47	XCR	M919-S47
650 QUEST 02-05 (RIGHT)	QUALIFIER	1720-0234	QUALIFIER	-
	XCR	M920-S47	XCR	-
650 TRAXTER CVT/MAX 05 (LEFT)	QUALIFIER	1720-0233	QUALIFIER	-
	XCR	M919-S47	XCR	-
650 TRAXTER CVT/MAX 05 (RIGHT)	QUALIFIER	1720-0234	QUALIFIER	1720-0233
	XCR	M920-S47	XCR	M919-S47
800 OUTLANDER R STD/XT/EFI 12-15 (LEFT)	XCR	1721-1445	XCR	-
800 OUTLANDER R STD/XT/EFI 12-15 (RIGHT)	XCR	1721-1446	XCR	1721-1446
800 OUTLANDER R XMR 11-12 (LEFT)	QUALIFIER	1720-0234	QUALIFIER	-
	XCR	M920-S47	XCR	-
800 OUTLANDER R XMR 11-12 (RIGHT)	QUALIFIER	1720-0233	QUALIFIER	1720-0234
	XCR	M919-S47	XCR	M920-S47
800 OUTLANDER R XXC 11 (LEFT)	QUALIFIER	1720-0234	QUALIFIER	-
	XCR	M920-S47	XCR	-
800 OUTLANDER R XXC 11 (RIGHT)	QUALIFIER	1720-0233	QUALIFIER	1720-0234
	XCR	M919-S47	XCR	M920-S47
800 OUTLANDER STD/LTD/R XMR/R XXM/XT 07-12 (LEFT)	QUALIFIER	1720-0234	QUALIFIER	-
	XCR	M920-S47	XCR	-
800 OUTLANDER STD/LTD/R XMR/R XXM/XT 07-12 (RIGHT)	QUALIFIER	1720-0233	QUALIFIER	1720-0234
	XCR	M919-S47	XCR	M920-S47
800 R OUTLANDER MAX 4X4 (STD/XT/XT-P) 13-14 (LEFT)	XCR	1721-1445	XCR	-
800 R OUTLANDER MAX 4X4 (STD/XT/XT-P) 13-14 (RIGHT)	XCR	1721-1446	XCR	1721-1446
800 RENEGADE R XXC 11 (LEFT)	QUALIFIER	1720-0234	QUALIFIER	-
	XCR	M920-S47	XCR	-
800 RENEGADE R XXC 11 (RIGHT)	QUALIFIER	1720-0233	QUALIFIER	1720-0234
	XCR	M919-S47	XCR	M920-S47
800 RENEGADE R/STD/XXC 12-15 (LEFT)	XCR	1721-1445	XCR	1721-1445
800 RENEGADE R/STD/XXC 12-15 (RIGHT)	XCR	1721-1446	XCR	1721-1446
COMMANDER 800 R/XT/DPS 11-16 (LEFT)	XCR	M412-S47	XCR	-
	QUALIFIER	1720-0238	QUALIFIER	-
COMMANDER 800 R/XT/DPS 11-16 (RIGHT)	XCR	M411-S47	XCR	M411-S47
	QUALIFIER	1720-0237	QUALIFIER	1720-0237
COMMANDER 800 R/XT/DPS 17-18 (LEFT)	XCR	1721-1889	XCR	M920-S47
	QUALIFIER	-	QUALIFIER	1720-0234
COMMANDER 800 R/XT/DPS 17-18 (RIGHT)	XCR	1721-1888	XCR	M919-S47
	QUALIFIER	-	QUALIFIER	1720-0233
COMMANDER MAX 800 R/XT/DPS 17-18 (LEFT)	QUALIFIER	-	QUALIFIER	1720-0234

BRAKING

FITS MODEL	COMPOUND	FRONT PART #	COMPOUND	REAR PART #
BRAKE PADS & SHOES (CON'T)				
CAN-AM (CON'T)				
COMMANDER MAX 800 R/XT/DPS 17-18 LEFT (CON'T)	XCR	1721-1889	XCR	M920-S47
COMMANDER MAX 800 R/XT/DPS 17-18 (RIGHT)	QUALIFIER	-	QUALIFIER	1720-0233
	XCR	1721-1888	XCR	M919-S47
DEFENDER DPS 800 R EFI 16-19 (LEFT)	XCR	1721-2495	XCR	1721-2497
DEFENDER DPS 800 R EFI 16-19 (RIGHT)	XCR	1721-2496	XCR	1721-2498
DEFENDER XT 800 R EFI 16-19 (LEFT)	XCR	1721-2495	XCR	1721-2497
DEFENDER XT 800 R EFI 16-19 (RIGHT)	XCR	1721-2496	XCR	1721-2498
RENEGADE 800/800R/EFI 07-11 (LEFT)	QUALIFIER	1720-0234	QUALIFIER	-
	XCR	M920-S47	XCR	-
RENEGADE 800/800R/EFI 07-11 (RIGHT)	QUALIFIER	1720-0233	QUALIFIER	1720-0234
	XCR	M919-S47	XCR	M920-S47
OUTLANDER 850 ALL 16-19 (LEFT)	XCR	1721-1445	XCR	1721-1445
OUTLANDER 850 ALL 16-19 (RIGHT)	XCR	1721-1446	XCR	1721-1446
850 RENEGADE EFI 16-19 (LEFT)	XCR	1721-1445	XCR	1721-1445
850 RENEGADE EFI 16-19 (RIGHT)	XCR	1721-1446	XCR	1721-1446
COMMANDER 1000 R/XT/DPS 17-18 (LEFT)	XCR	1721-1889	XCR	M920-S47
	QUALIFIER	-	QUALIFIER	1720-0234
COMMANDER 1000 R/XT/DPS 17-18 (RIGHT)	XCR	1721-1888	XCR	M919-S47
	QUALIFIER	-	QUALIFIER	1720-0233
COMMANDER 1000 11-16 (LEFT)	XCR	M412-S47	XCR	-
	QUALIFIER	1720-0238	QUALIFIER	-
COMMANDER 1000 11-16 (RIGHT)	XCR	M411-S47	XCR	M411-S47
	QUALIFIER	1720-0237	QUALIFIER	1720-0237
COMMANDER 1000 DPS/LTD/X/XT/XT-P 11-16 (LEFT)	XCR	M412-S47	XCR	-
	QUALIFIER	1720-0238	QUALIFIER	-
COMMANDER 1000 DPS/LTD/X/XT/XT-P 11-16 (RIGHT)	XCR	M411-S47	XCR	M411-S47
	QUALIFIER	1720-0237	QUALIFIER	1720-0237
COMMANDER 1000 XT-P 14-15 (LEFT)	XCR	M412-S47	XCR	-
	QUALIFIER	1720-0238	QUALIFIER	-
COMMANDER 1000 XT-P 14-15 (RIGHT)	XCR	M411-S47	XCR	M411-S47
	QUALIFIER	1720-0237	QUALIFIER	1720-0237
COMMANDER MAX 1000 DPS/LTD/XT 14-19 (LEFT)	QUALIFIER	-	QUALIFIER	1720-0234
	XCR	1721-1889	XCR	M920-S47
COMMANDER MAX 1000 DPS/LTD/XT 14-19 (RIGHT)	QUALIFIER	-	QUALIFIER	1720-0233
	XCR	1721-1888	XCR	M919-S47
MAVERICK 1000R 14-18 (LEFT)	XCR	M412-S47	XCR	M920-S47
	QUALIFIER	1720-0238	QUALIFIER	1720-0234
MAVERICK 1000R 14-18 (RIGHT)	XCR	M411-S47	XCR	M919-S47
	QUALIFIER	1720-0237	QUALIFIER	1720-0233
MAVERICK MAX 1000R/XMR/XXC 13 (LEFT)	QUALIFIER	1720-0238	QUALIFIER	1720-0234
	XCR	M412-S47	XCR	M920-S47
MAVERICK MAX 1000R/XMR/XXC 13 (RIGHT)	QUALIFIER	1720-0237	QUALIFIER	1720-0233
	XCR	M411-S47	XCR	M919-S47
MAVERICKMAX 1000 STD/XDS-DPS/XRS-DPS 14-15 (LEFT)	QUALIFIER	-	QUALIFIER	1720-0234
	XCR	1721-2166	XCR	M920-S47
MAVERICKMAX 1000 STD/XDS-DPS/XRS-DPS 14-15 (RIGHT)	QUALIFIER	-	QUALIFIER	1720-0233
	XCR	1721-2165	XCR	M919-S47
MAVERICK X3 17-19 (LEFT)	XCR	1721-2495	XCR	1721-2495
MAVERICK X3 17-19 (RIGHT)	XCR	1721-2496	XCR	1721-2496
OUTLANDER 1000 4X4 DPS/XT/XTP/LTD/XMR 13-19 (LEFT)	XCR	1721-1445	XCR	-
OUTLANDER 1000 4X4 DPS/XT/XTP/LTD/XMR 13-19 (RIGHT)	XCR	1721-1446	XCR	1721-1446
OUTLANDER 1000 STD/XT 12-18 (LEFT)	XCR	1721-1445	XCR	-
OUTLANDER 1000 STD/XT 12-18 (RIGHT)	XCR	1721-1446	XCR	1721-1446
RENEGADE 1000 STD/XXC 12-16 (LEFT)	XCR	1721-1445	XCR	1721-1445
RENEGADE 1000 STD/XXC 12-16 (RIGHT)	XCR	1721-1446	XCR	1721-1446
CF MOTO				
400 C-FORCE 14-16	XCR	1721-1884	XCR	M930-S47
400 C-FORCE 14-16 (PARK BRAKE)	XCR	-	XCR	M909-S47
500 C-FORCE 14-16	XCR	1721-1884	XCR	M930-S47
500 C-FORCE 14-16 (PARK BRAKE)	XCR	-	XCR	M909-S47
500 C-FORCE HO EPS 14-16	XCR	1721-1884	XCR	M920-S47

FITS MODEL	COMPOUND	FRONT PART #	COMPOUND	REAR PART #
BRAKE PADS & SHOES (CON'T)				
CF MOTO (CON'T)				
500 U-FORCE EPS 14-16 (LEFT)	XCR	M412-S47	XCR	M310-S47
	QUALIFIER	1720-0238	QUALIFIER	-
500 U-FORCE EPS 14-16 (RIGHT)	XCR	M411-S47	XCR	M310-S47
	QUALIFIER	1720-0237	QUALIFIER	-
500 Z-FORCE 14-16 (LEFT)	XCR	M412-S47	XCR	-
	QUALIFIER	1720-0238	QUALIFIER	-
500 Z-FORCE 14-16 (RIGHT)	XCR	M411-S47	XCR	-
	QUALIFIER	1720-0237	QUALIFIER	-
550 U-FORCE 16-19 (LEFT)	XCR	M411-S47	XCR	M310-S47
550 U-FORCE 16-19 (RIGHT)	XCR	M412-S47	XCR	M310-S47
800 C-FORCE EPS 14-16	XCR	1721-1884	XCR	M930-S47
800 EX Z-FORCE 14-16 (LEFT)	XCR	M412-S47	XCR	-
	QUALIFIER	1720-0238	QUALIFIER	-
800 EX Z-FORCE 14-16 (RIGHT)	XCR	M411-S47	XCR	-
	QUALIFIER	1720-0237	QUALIFIER	-
800 U-FORCE 14-19 (LEFT)	XCR	M412-S47	XCR	-
	QUALIFIER	1720-0238	QUALIFIER	-
800 U-FORCE 14-19 (RIGHT)	XCR	M411-S47	XCR	-
	QUALIFIER	1720-0237	QUALIFIER	-
800 Z-FORCE 15-16 (LEFT)	XCR	M412-S47	XCR	-
	QUALIFIER	1720-0238	QUALIFIER	-
800 Z-FORCE 15-16 (RIGHT)	XCR	M411-S47	XCR	-
	QUALIFIER	1720-0237	QUALIFIER	-
HONDA				
ATC70 76-77	XCR	-	XCR	M9100
ATC70 78-85	XCR	M9122	XCR	-
TRX70 86-87	XCR	1723-0139	XCR	1723-0133
ATC90 73-78	XCR	-	XCR	M9122
ATC110 79-85	XCR	-	XCR	M9122
ATC125 84-87	XCR	M9100	XCR	M9122
TRX125 85-88	XCR	M9100	XCR	M9122
ATC185 80-83	XCR	M9100	XCR	M9122
ATC200 84-86	XCR	M9100	XCR	M9122
ATC200ES BIG RED 81-84	XCR	M9100	XCR	M9122
ATC200X 83-85	QUALIFIER	1720-0229	QUALIFIER	1720-0229
	XCR	M811-S47	XCR	M811-S47
ATC200X 86-87	QUALIFIER	1720-0229	QUALIFIER	1720-0229
	XCR	M811-S47	XCR	M811-S47
TRX200 84	XCR	M9149	XCR	M9122
TRX200/SX 86-98	XCR	M9149	XCR	M9122
ATC250ES BIG RED 85-87	XCR	M9122	XCR	M9119
ATC250SX 85-87	XCR	M9122	XCR	M9119
FL250 ODYSSEY 77-83	XCR	-	XCR	M9122
FL250 ODYSSEY 84	XCR	-	XCR	M9122
TRX250 85-87	XCR	M9146	XCR	M9119
TRX250 TE/TEA RECON ES 07-09/11-19	XCR	M9149	XCR	M9186
TRX250X 08-09/11-14	QUALIFIER	1720-0229	QUALIFIER	-
	XCR	M811-S47	XCR	M9186
TRX300 2WD 88-00	XCR	M9149	XCR	M9119
TRX300 4WD 88-00	XCR	M9150	XCR	M9119
ATC350X 85	QUALIFIER	-	QUALIFIER	1720-0229
	XCR	M812-S47	XCR	M811-S47
ATC350X 86	QUALIFIER	1720-0250	QUALIFIER	1720-0229
	XCR	M814-S47	XCR	M811-S47
FL350 ODYSSEY 85-87	XCR	M9146	XCR	-
TRX350 RANCHER 00-06 (ALL)	XCR	M9150	XCR	M9167
TRX350/D 86-89	XCR	-	XCR	1723-0136
FL400R PILOT 89-90	XCR	M9146	XCR	-
TRX400FA/FGA RANCHER AT 04-07	XCR	M9150	XCR	M9167
TRX400FW 4WD 95-02	XCR	M9150	XCR	M9167
TRX420 FOURTRAX RANCHER AT/ES/2X4/4X4 07-19	QUALIFIER	1720-0229	QUALIFIER	-
	XCR	M811-S47	XCR	M9167
TRX450ES/S 98-03	QUALIFIER	-	QUALIFIER	-
	XCR	M9150	XCR	M9167
TRX500 FOREMAN (FA/FM) RUBICON 4X4/AUTO/DCT/EPS 05-14	QUALIFIER	1720-0229	QUALIFIER	-
	XCR	M811-S47	XCR	M9167
TRX500 FOREMAN FA 15-19	QUALIFIER	1720-0229	QUALIFIER	-
	XCR	M811-S47	XCR	1721-0748
TRX500 FOURTRAX FOREMAN 2X4/4X4 05-11	XCR	1721-0622	XCR	1723-0136
TRX500 FOURTRAX FOREMAN FE/FM/FPE/FPM 12-19	QUALIFIER	1720-0229	QUALIFIER	-
	XCR	M811-S47	XCR	1723-0136

FITS MODEL	COMPOUND	FRONT PART #	COMPOUND	REAR PART #
BRAKE PADS & SHOES (CON'T)				
HONDA (CON'T)				
TRX500 RUBICON 01-04	XCR	M9150	XCR	1723-0136
TRX500 RUBICON 05-16	XCR	1721-0622	XCR	1723-0136
TRX500(FE/FM) FOREMAN ES/EPS 14-15	QUALIFIER	1720-0229	QUALIFIER	-
	XCR	M811-S47	XCR	M9167
TRX650 RINCON 03-05	XCR	M9150	XCR	1721-0748
TRX650 RINCON 06-07	XCR	-	XCR	1721-0748
TRX680 FOURTRAX RINCON/GPSCAPE 06-19	XCR	1721-0622	XCR	1721-0748
PIONEER 700 SXS M2/M4 14-18 (RIGHT)	XCR	-	XCR	1721-0748
PIONEER 700-4 14-19 (LEFT)	XCR	-	XCR	-
PIONEER 700-4 14-19 (RIGHT)	XCR	-	XCR	1721-0748
PIONEER 1000 SXS 16-19	XCR	1721-2491	XCR	1721-0622
JOHN DEERE				
TRAIL BUCK 500/650 EX/EXT 04-05 (RIGHT)	XCR	M920-S47	XCR	M919-S47
TRAIL BUCK 500/650 EX/EXT 04-05 (LEFT)	XCR	M919-S47	XCR	-
KAWASAKI				
KLT110 84-86	XCR	1723-0001	XCR	-
KLT160 85	XCR	1723-0001	XCR	-
KLF185 85	XCR	-	XCR	M9117
KLF185 BAYOU 86-88	XCR	M9161	XCR	M9117
KLT185 86-87	XCR	1723-0001	XCR	-
KLT200 81-84	XCR	1723-0001	XCR	M9161
KLF220 BAYOU 88-02	XCR	M9161	XCR	M9117
KLF250 BAYOU 03-11	XCR	M9161	XCR	M9117
KLT250 82-85	XCR	1723-0001	XCR	M9161
KLT250C 84	XCR	1723-0001	XCR	M9161
KAF300 (MULE 500) 92-95	XCR	-	XCR	M9202
KAF300C (MULE 550) 97-00	XCR	M9158	XCR	M9202
KAF300D (MULE 250)	XCR	M9158	XCR	M9202
KLF300 BAYOU 86-87	XCR	-	XCR	M9117
KLF300B BAYOU 2X4 88-04	XCR	M310-S47	XCR	M9117
KLF300C BAYOU 4X4 89-05 (LEFT)	XCR	M411-S47	XCR	M9145
	QUALIFIER	1720-0237	QUALIFIER	-
KLF300C BAYOU 4X4 89-05 (RIGHT)	XCR	M412-S47	XCR	-
	QUALIFIER	1720-0238	QUALIFIER	-
KVF300 PRAIRIE 2X4/4X4 99-02	XCR	M107-S47	XCR	M9145
	QUALIFIER	1720-0231	QUALIFIER	-
KVF360 PRAIRIE 4X4 03-13 (ALL)	XCR	M107-S47	XCR	-
	QUALIFIER	1720-0231	QUALIFIER	-
KAF400 (MULE 610, 4X4, SX, SE, ALL) 17-19	XCR	M9202	XCR	M9202
KAF400 B/BAF (MULE 600 2X4) 06-18	XCR	M9202	XCR	M9202
KAF400 FEF (MULE 610 4X4/XC/CAMD/SE) 10-18	XCR	M9202	XCR	M9202
KLF400 BAYOU 93-99 (LEFT)	XCR	M411-S47	XCR	M9145
	QUALIFIER	1720-0237	QUALIFIER	-
KLF400 BAYOU 93-99 (RIGHT)	XCR	M412-S47	XCR	-
	QUALIFIER	1720-0238	QUALIFIER	-
KVF400 C/D PRAIRIE 2WD/4WD 97-02	XCR	M107-S47	XCR	M9145
	QUALIFIER	1720-0231	QUALIFIER	-
KAF450B (MULE 1000)	XCR	M9203	XCR	M9204
KAF540C/D/E (MULE 2010/2020/2030)	XCR	M9203	XCR	M9204
KAF620 MULE 3100 4X4 03-05	XCR	M9203	XCR	M9204
KAF620 MULE 4000/4010 09-19	XCR	M9203	XCR	M9204
KAF620A/B/C (MULE 2500/2510/2520)	XCR	M9203	XCR	M9204
KAF620E/F/G (MULE 3000/3010/3020)	XCR	M9204	XCR	M9204
KVF650 D/E BRUTE FORCE 4X4 05-11 (LEFT)	XCR	M929-S47	XCR	-
KVF650 D/E BRUTE FORCE 4X4 05-11 (RIGHT)	XCR	M326-S47	XCR	-
KVF650 F/H BRUTE FORCE 4X4 05-13 (LEFT)	XCR	M411-S47	XCR	-
	QUALIFIER	1720-0237	QUALIFIER	-
KVF650 F/H BRUTE FORCE 4X4 05-13 (RIGHT)	XCR	M412-S47	XCR	-
	QUALIFIER	1720-0238	QUALIFIER	-
KVF650A1 PRAIRIE 02-03 (LEFT)	XCR	M929-S47	XCR	-
KVF650A1 PRAIRIE 02-03 (RIGHT)	XCR	M326-S47	XCR	-
KVF700 PRAIRIE 4X4 04-06 (ALL) (LEFT)	XCR	M929-S47	XCR	-
KVF700 PRAIRIE 4X4 04-06 (ALL) (RIGHT)	XCR	M326-S47	XCR	-
KVF750 BRUTE FORCE 4X4 04-19 (ALL) (LEFT)	XCR	M411-S47	XCR	-

FITS MODEL	COMPOUND	FRONT PART #	COMPOUND	REAR PART #
BRAKE PADS & SHOES (CON'T)				
KAWASAKI (CON'T)				
KVF750 BRUTE FORCE 4X4 04-19 (ALL) (LEFT) (CON'T)	QUALIFIER	1720-0237	QUALIFIER	-
KVF750 BRUTE FORCE 4X4 04-19 (ALL) (RIGHT)	XCR	M412-S47	XCR	-
	QUALIFIER	1720-0238	QUALIFIER	-
KXF700 FORCE 04-09 (LEFT)	XCR	M929-S47	XCR	-
KXF700 FORCE 04-09 (RIGHT)	XCR	M326-S47	XCR	-
KAF 700 MULE PRO-MX (ALL MODELS) 19 (LEFT FRONT)	XCR	1721-2877	XCR	1721-2876
KAF 700 MULE PRO-MX (ALL MODELS) 19 (RIGHT FRONT)	XCR	1721-2878	XCR	1721-2876
TERYX 750 08-13 (ALL) (LEFT)	XCR	M411-S47	XCR	-
TERYX 750 08-13 (ALL) (RIGHT)	XCR	M412-S47	XCR	-
TERYX 800 / TERYX 4/ CAMO/LE/SPORT 14-19 (LEFT)	XCR	M411-S47	XCR	-
TERYX 800 / TERYX 4/CAMO/LE/SPORT 14-19 (RIGHT)	XCR	M412-S47	XCR	-
KAF820 MULE PRO (BFF/CFF) ALL 15-19 (LEFT)	XCR	M412-S47	XCR	-
KAF820 MULE PRO (BFF/CFF) ALL 15-19 (RIGHT)	XCR	M411-S47	XCR	-
KAF920A2 MULE 2510 DIESEL 02	XCR	M9203	XCR	M9204
KAF950A/B (MULE 2510/3010 DIESEL) 03-05	XCR	M9203	XCR	M9204
KAF950D/E/F/G MULE 3010/4010 08-12	XCR	M9203	XCR	M9204
KAF1000 MULE PRO DX/OXT/EPS/LE (ALL) 16-17 (LEFT)	XCR	M412-S47	XCR	-
KAF1000 MULE PRO DX/OXT/EPS/LE (ALL) 16-17 (RIGHT)	XCR	M411-S47	XCR	-
KYMCO				
MX50 MONGOOSE 04-08	XCR	1723-0139	XCR	1723-0140
MONGOOSE 50 (REAR DISC MODEL) 08-09	XCR	1723-0139	XCR	-
MX70 MONGOOSE 07-16	XCR	1723-0139	XCR	-
MX90 MONGOOSE /R/(REVERSE GEAR) 02-16	XCR	1723-0139	XCR	-
MX ER 125/150 QUAD 02-05	XCR	-	XCR	-
MXU150 05-14	XCR	M9100	XCR	-
MXU 400 08-09	XCR	1721-0621	XCR	1721-0621
MAXXER 450 4X4IRS 11-16	XCR	1721-0621	XCR	-
MAXXER 450 18-19	XCR	1721-0621	XCR	1721-0621
MAXXER 450 RI 12-15	XCR	1721-0621	XCR	1721-1886
MXU 450 I 12-13	XCR	1721-0621	XCR	1721-1886
MXU 500 I DX 12-13	XCR	1721-1885	XCR	-
MXU 550 I 12-14	XCR	1721-1885	XCR	1721-1886
MXU 500 IRS 4X4 (CARB & EFI) 10-12	XCR	1721-1885	XCR	1721-1886
MXU 700I (ALL) 14-18	XCR	1721-1885	XCR	1721-1886
MXU 700 I 13-18	XCR	1721-1885	XCR	1721-1886
MXU 700 19	XCR	1721-1885	XCR	-
MXU 700 I EX 19	XCR	1721-1885	XCR	1721-0621
MXU 700 I 13-18	XCR	1721-1885	XCR	1721-1886
UXV 700 I 14	XCR	1721-0621	XCR	1721-1886
POLARIS				
DISC BRAKE MODELS 88-94	QUALIFIER	1720-0230	QUALIFIER	-
	XCR	M902-S47	XCR	-
DISC BRAKE MODELS 95-98	QUALIFIER	1720-0230	QUALIFIER	-
	XCR	M902-S47	XCR	M909-S47
90 SPORTSMAN 01-14	XCR	1723-0138	XCR	1723-0140
110 SPORTSMAN 12-19	XCR	1723-0138	XCR	1723-0140
150 ACE 17-19	XCR	M107-S47	XCR	M919-S47
200 PHOENIX (REAR DRUM MODEL) 06-19	XCR	M312-S47	XCR	M9122
200 SAWTOOTH 06-07	XCR	M312-S47	XCR	M9122
250 TRAIL BOSS 98-01	QUALIFIER	1720-0230	QUALIFIER	-
	XCR	M902-S47	XCR	M909-S47
250 TRAILBLAZER 94-98	QUALIFIER	1720-0230	QUALIFIER	-
	XCR	M902-S47	XCR	M909-S47
250 TRAILBLAZER ES 05-06	QUALIFIER	1720-0230	QUALIFIER	1720-0240
	XCR	M902-S47	XCR	M932-S47
250 TRAILBLAZER ES 99-04	QUALIFIER	1720-0230	QUALIFIER	1720-0235
	XCR	M902-S47	XCR	M915-S47
250 XPLORER 00-01	QUALIFIER	1720-0230	QUALIFIER	1720-0235
	XCR	M902-S47	XCR	M915-S47
250 XPLORER 4X4 00-01	QUALIFIER	1720-0230	QUALIFIER	1720-0235
	XCR	M902-S47	XCR	M915-S47
300 HAWKEYE 2X4/4X4 06	QUALIFIER	1720-0232	QUALIFIER	1720-0232

PLOWS
WINCHES
UTV
RACKS
IMPLEMENTS & TOWING
LUGGAGE
BODY
CONTROLS
ELECTRICAL
WHEELS & TIRES
SUSPENSION & DRIVE
BRAKING
ENGINE
RIDER
GARAGE
PROMO

BRAKING

FITS MODEL	COMPOUND	FRONT PART #	COMPOUND	REAR PART #
BRAKE PADS & SHOES (CON'T)				
POLARIS (CON'T)				
300 HAWKEYE 2X4/4X4 06 (CON'T)	XCR	1721-0621	XCR	1721-0621
300 HAWKEYE 2X4/4X4 07-09	QUALIFIER	1720-0230	QUALIFIER	1720-0230
	XCR	M902-S47	XCR	M902-S47
300 SPORTSMAN 4X4 08-10	QUALIFIER	1720-0230	QUALIFIER	1720-0230
	XCR	M902-S47	XCR	M902-S47
300 XPLORER 96-01	QUALIFIER	1720-0230	QUALIFIER	-
	XCR	M902-S47	XCR	M909-S47
300 XPRESS 96-00	QUALIFIER	1720-0230	QUALIFIER	-
	XCR	M902-S47	XCR	M909-S47
325 HAWKEYE 2X4 15	QUALIFIER	1720-0230	QUALIFIER	-
	XCR	M902-S47	XCR	1721-1228
325 MAGNUM 2X4 02	QUALIFIER	1720-0230	QUALIFIER	1720-0240
	XCR	M902-S47	XCR	M932-S47
325 MAGNUM 2X4/4X4 00-01	QUALIFIER	1720-0230	QUALIFIER	1720-0235
	XCR	M902-S47	XCR	M915-S47
325 SPORTSMAN ACE /EFI/EURO/HD 14-18	QUALIFIER	-	QUALIFIER	1720-0242
	XCR	1721-1229	XCR	1721-1230
325 TRAIL BOSS 00	QUALIFIER	1720-0230	QUALIFIER	1720-0235
	XCR	M902-S47	XCR	M915-S47
325 TRAIL BOSS 01-02	QUALIFIER	1720-0230	QUALIFIER	1720-0235
	XCR	M902-S47	XCR	M915-S47
330 ATP 4X4 04-06	QUALIFIER	1720-0230	QUALIFIER	1720-0230
	XCR	M902-S47	XCR	M902-S47
330 MAGNUM 2X4/4X4 HDS 03-06	QUALIFIER	1720-0230	QUALIFIER	1720-0240
	XCR	M902-S47	XCR	M932-S47
330 TRAIL BOSS 03-04	QUALIFIER	1720-0230	QUALIFIER	1720-0235
	XCR	M902-S47	XCR	M915-S47
330 TRAIL BOSS 05-13	QUALIFIER	1720-0230	QUALIFIER	1720-0240
	XCR	M902-S47	XCR	M932-S47
330 TRAILBLAZER 04	QUALIFIER	1720-0230	QUALIFIER	1720-0235
	XCR	M902-S47	XCR	M915-S47
330 TRAILBLAZER 08-13	QUALIFIER	1720-0230	QUALIFIER	1720-0240
	XCR	M902-S47	XCR	M932-S47
335 SPORTSMAN 98-00	QUALIFIER	1720-0230	QUALIFIER	1720-0235
	XCR	M902-S47	XCR	M915-S47
350L SPORTSMAN/TRAIL BOSS 90-93	QUALIFIER	1720-0230	QUALIFIER	-
	XCR	M902-S47	XCR	M909-S47
400 BIG BOSS L 6X6 (MIDDLE AXLE BRAKE) 94-95, 97	QUALIFIER	1720-0230	QUALIFIER	-
	XCR	M902-S47	XCR	M909-S47
400 BIG BOSS L 6X6 (MIDDLE AXLE BRAKE) 96	QUALIFIER	1720-0230	QUALIFIER	-
	XCR	M902-S47	XCR	M909-S47
400 RANGER 4X4 10-14 (ALL)	QUALIFIER	1720-0242	QUALIFIER	1720-0242
	XCR	1721-1230	XCR	1721-1230
400 SPORTSMAN 01-02	QUALIFIER	1720-0230	QUALIFIER	1720-0235
	XCR	M902-S47	XCR	M915-S47
400 SPORTSMAN 03-05	QUALIFIER	1720-0230	QUALIFIER	1720-0240
	XCR	M902-S47	XCR	M932-S47
400 SPORTSMAN HO 4X4 08-10	QUALIFIER	1720-0230	QUALIFIER	1720-0230
	XCR	M902-S47	XCR	M902-S47
400 SPORTSMAN HO 4X4 11-14	QUALIFIER	1720-0230	QUALIFIER	-
	XCR	M902-S47	XCR	1721-1228
400 TRAILBLAZER 03	QUALIFIER	1720-0230	QUALIFIER	1720-0235
	XCR	M902-S47	XCR	M915-S47
400 XPLORER 98	QUALIFIER	1720-0230	QUALIFIER	-
	XCR	M902-S47	XCR	M909-S47
400 XPLORER 99-02	QUALIFIER	1720-0230	QUALIFIER	1720-0235
	XCR	M902-S47	XCR	M915-S47
400L SPORTSMAN 94-98	QUALIFIER	1720-0230	QUALIFIER	-
	XCR	M902-S47	XCR	M909-S47
425 MAGNUM 6X6 96-01	QUALIFIER	1720-0230	QUALIFIER	-
	XCR	M902-S47	XCR	1721-1228
425 MAGNUM 95-98	QUALIFIER	1720-0230	QUALIFIER	-
	XCR	M902-S47	XCR	M909-S47
425 XPEDITION 4X4 00	QUALIFIER	1720-0230	QUALIFIER	1720-0235
	XCR	M902-S47	XCR	M915-S47
425 XPEDITION 4X4 02	QUALIFIER	1720-0230	QUALIFIER	1720-0235
	XCR	M902-S47	XCR	M915-S47
450 SPORTSMAN 06-19	QUALIFIER	1720-0230	QUALIFIER	1720-0240
	XCR	M902-S47	XCR	M932-S47
450 SPORTSMAN HO EFI MD TRACTOR 16-18	QUALIFIER	1720-0230	QUALIFIER	-
	XCR	M902-S47	XCR	1721-1228

FITS MODEL	COMPOUND	FRONT PART #	COMPOUND	REAR PART #
BRAKE PADS & SHOES (CON'T)				
POLARIS (CON'T)				
455 DIESEL 99-00	QUALIFIER	1720-0230	QUALIFIER	-
	XCR	M902-S47	XCR	M909-S47
455 DIESEL EBS 4X4 99-01	QUALIFIER	1720-0230	QUALIFIER	1720-0235
	XCR	M902-S47	XCR	M915-S47
500 ATP 04-05	QUALIFIER	1720-0230	QUALIFIER	1720-0230
	XCR	M902-S47	XCR	M902-S47
500 MAGNUM 2X4/4X4 02-03	QUALIFIER	1720-0230	QUALIFIER	1720-0240
	XCR	M902-S47	XCR	M932-S47
500 MAGNUM 99-01	QUALIFIER	1720-0230	QUALIFIER	1720-0235
	XCR	M902-S47	XCR	M915-S47
500 MAGNUM RMK 4X4 02	QUALIFIER	1720-0230	QUALIFIER	1720-0240
500 MAGNUM RMK 4X4 02 (CON'T)	XCR	M902-S47	XCR	M932-S47
500 RANGER 2X4/4X4 08-10 (CARB & EFI)	QUALIFIER	-	QUALIFIER	1720-0242
	XCR	1721-1229	XCR	1721-1230
500 RANGER 4X4 EFI 11-19	QUALIFIER	1720-0242	QUALIFIER	1720-0242
	XCR	1721-1230	XCR	1721-1230
500 RANGER 6X6 04-05	QUALIFIER	1720-0242	QUALIFIER	1720-0242
	XCR	1721-1230	XCR	1721-1230
500 RANGER SERIES 10 6X6	QUALIFIER	1720-0242	QUALIFIER	1720-0242
	XCR	1721-1230	XCR	1721-1230
500 SPORTSMAN 6X6 00-06	QUALIFIER	1720-0230	QUALIFIER	-
	XCR	M902-S47	XCR	-
500 SPORTSMAN 98-02	QUALIFIER	1720-0230	QUALIFIER	1720-0235
	XCR	M902-S47	XCR	M915-S47
500 SPORTSMAN EFI/HO 03-10 (ALL)	QUALIFIER	1720-0230	QUALIFIER	1720-0240
	XCR	M902-S47	XCR	M932-S47
500 SPORTSMAN ER QUAD HO 08-11	QUALIFIER	1720-0230	QUALIFIER	1720-0240
	XCR	M902-S47	XCR	M932-S47
500 SPORTSMAN TOURING HO 08 (BUILT UP TO 12/15/08)	QUALIFIER	1720-0230	QUALIFIER	1720-0230
	XCR	M902-S47	XCR	M902-S47
500 SPORTSMAN TOURING HO 09-13 (BUILT FROM 12/16/08)	QUALIFIER	1720-0230	QUALIFIER	-
	XCR	M902-S47	XCR	1721-1228
500 SPORTSMAN X2 06-09	QUALIFIER	1720-0230	QUALIFIER	-
	XCR	M902-S47	XCR	-
525 OUTLAW S/IRS 07-11	QUALIFIER	-	QUALIFIER	1720-0230
	XCR	1721-0836	XCR	M902-S47
550 SPORTSMAN XP/X2 09-14	XCR	1721-1228	XCR	1721-1228
550 SPORTSMAN/EPS/FOREST/TOURING 10-15	QUALIFIER	-	QUALIFIER	1720-0230
	XCR	1721-0836	XCR	M902-S47
570 RANGER RZR 12-19 (ALL)	QUALIFIER	-	QUALIFIER	1721-1230
	XCR	1721-1229	XCR	1721-1230
570 RANGER FULL SIZE 15-19	QUALIFIER	-	QUALIFIER	1720-0242
	XCR	1721-1229	XCR	1721-1230
570 SPORTSMAN ACE/EURO 15-19	QUALIFIER	-	QUALIFIER	-
	XCR	1721-1229	XCR	1721-1230
570 SPORTSMAN EFI/EP/S/TOURING 11-19	QUALIFIER	1720-0230	QUALIFIER	-
	XCR	M902-S47	XCR	1721-1228
600 SPORTSMAN 03-05	QUALIFIER	1720-0230	QUALIFIER	1720-0240
	XCR	M902-S47	XCR	M932-S47
700 RANGER 6X4 EFI 08-09	QUALIFIER	-	QUALIFIER	1720-0242
	XCR	1721-1229	XCR	1721-1230
700 RANGER 6X6 EFI 06-09	QUALIFIER	-	QUALIFIER	1720-0242
	XCR	1721-1229	XCR	1721-1230
700 RANGER XP 4X4 08-09	QUALIFIER	-	QUALIFIER	1720-0242
	XCR	1721-1229	XCR	1721-1230
700 SPORTSMAN 4X4 02-06 (ALL)	QUALIFIER	1720-0230	QUALIFIER	1720-0240
	XCR	M902-S47	XCR	M932-S47
800 RANGER EV/HD/XP 10, 13-14	XCR	1721-1229	XCR	1721-1229
800 RANGER EV/HD/XP 11-12	XCR	1721-1229	XCR	-
800 RANGER RZR/ RZR S ER 08-14	QUALIFIER	-	QUALIFIER	1720-0230
	XCR	1721-0836	XCR	M902-S47
800 RANGER RZR-4 10-14	QUALIFIER	-	QUALIFIER	1720-0242
	XCR	1721-1229	XCR	1721-1230
800 RANGER/6X6 /CREW / 10-16	XCR	1721-1229	XCR	1721-1229
800 RANGER EFI MIDSIZED PARKING BRAKE 13-14	XCR	-	XCR	1721-1737
800 SPORTSMAN EFI 05-07	QUALIFIER	1720-0230	QUALIFIER	1720-0240
	XCR	M902-S47	XCR	M932-S47
800 SPORTSMAN EFI 6X6 BIG BOSS 09-14	QUALIFIER	1720-0230	QUALIFIER	1720-0240
	XCR	M902-S47	XCR	M932-S47
800 SPORTSMAN X2 07-09	QUALIFIER	1720-0230	QUALIFIER	1720-0230

FITS MODEL	COMPOUND	FRONT PART #	COMPOUND	REAR PART #
BRAKE PADS & SHOES (CON'T)				
POLARIS (CON'T)				
800 SPORTSMAN X2 07-09 (CON'T)	XCR	M902-S47	XCR	M902-S47
800 SPORTSMAN/FOREST 12-14	QUALIFIER	1720-0230	QUALIFIER	-
	XCR	M902-S47	XCR	1721-1228
850 SPORTSMAN SCRAMBLER TOURING/EPS/SP 13-19	XCR	1721-1228	XCR	1721-1229
850 SPORTSMAN XP/EPS/HO 09-19 (ALL)	XCR	1721-1228	XCR	1721-1228
900 D RANGER 4X4 DIESEL 11-14	QUALIFIER	-	QUALIFIER	1720-0242
	XCR	1721-1229	XCR	1721-1230
900 RANGER DIESEL PARKING BRAKE 12-15	XCR	-	XCR	1721-1737
900 RANGER 15-19	XCR	1721-2167	XCR	1721-0836
900 RANGER RZR XP 12-14	QUALIFIER	-	QUALIFIER	1720-0242
	XCR	1721-1229	XCR	1721-1230
900 RANGER RZR XP 4 12-18	QUALIFIER	-	QUALIFIER	1720-0242
	XCR	1721-1229	XCR	1721-1230
900 RANGER XP 13-17	QUALIFIER	-	QUALIFIER	1720-0242
	XCR	1721-1229	XCR	1721-1230
900 SPORTSMAN ACE EFI EPS 16-19	QUALIFIER	-	QUALIFIER	1720-0242
	XCR	1721-1229	XCR	1721-1230
925 RZR XP 4 TURBO S 19	XCR	1721-2872	XCR	1721-1229
1000 RANGER BRUTUS 13-16	XCR	1721-1229	XCR	1721-1229
1000 RANGER CREW DIESEL 16-19	XCR	1721-1229	XCR	1721-1229
1000 RANGER RZR XP 14-19	XCR	1721-1229	XCR	1721-1229
1000 RANGER RZR XP 4 15-19	XCR	1721-1229	XCR	1721-1229
1000 RZR TURBO 16-19	XCR	1721-2494	XCR	1721-1229
1000 SPORTSMAN MD/XP 15	XCR	1721-1228	XCR	1721-1228
1000 SPORTSMAN XP ZUG 16-17	QUALIFIER	1720-0230	QUALIFIER	1720-0240
	XCR	M902-S47	XCR	M932-S47
SUZUKI				
LT160 89-92/03-04	XCR	M9155	XCR	M9133
LT-F160 91-01/04	XCR	M9155	XCR	M9133
ALTI85F 85	XCR	-	XCR	M9133
LT185 84-87	XCR	-	XCR	M9133
LT230E 86-93	QUALIFIER	-	QUALIFIER	1720-0229
	XCR	M821-S47	XCR	M811-S47
LT230G 85-87	XCR	M9156	XCR	M9133
LT230GE 85-86	XCR	M9156	XCR	M9133
LT230S 85-88	QUALIFIER	-	QUALIFIER	1720-0229
	XCR	M821-S47	XCR	M811-S47
LT-F230 86-87	XCR	M9156	XCR	M9133
LT250EFF/EF8 85-86	XCR	M9156	XCR	M9187
LT250R 88-92	QUALIFIER	-	QUALIFIER	1720-0241
	XCR	M821-S47	XCR	M817-S47
LT250SK/SL 89-90	QUALIFIER	-	QUALIFIER	1720-0229
	XCR	M821-S47	XCR	M811-S47
LT-F250 OZARK 02-19	QUALIFIER	1720-0229	QUALIFIER	-
	XCR	M811-S47	XCR	1723-0141
LT-F250 QUADRUNNER 88-02	XCR	M9158	XCR	M9159
LT300E 87-89	XCR	M9156	XCR	M9187
LT-4WD 87-92	XCR	M9158	XCR	M9159
LT-4WDX 91-98	XCR	M9160	XCR	M9157
LT-F300 KINGQUAD 02-03 (LEFT)	QUALIFIER	1720-0237	QUALIFIER	-
	XCR	M411-S47	XCR	-
LT-F300 KINGQUAD 02-03 (RIGHT)	QUALIFIER	1720-0238	QUALIFIER	-
	XCR	M412-S47	XCR	M9157
LT-F300 KINGQUAD 91-01	XCR	M9160	XCR	M9157
LT-A400 EIGER 02-09 (ALL)	QUALIFIER	1720-0231	QUALIFIER	-
	XCR	M107-S47	XCR	1723-0135
LT-A400 KING QUAD 08-19 (ALL) (LEFT)	QUALIFIER	1720-0234	QUALIFIER	-
	XCR	M920-S47	XCR	-
LT-A400 KING QUAD 08-19 (ALL) (RIGHT)	QUALIFIER	1720-0233	QUALIFIER	-
	XCR	M919-S47	XCR	1723-0135
LT-A400 KING QUAD ASI/ASL CAMO/FSI 11-17 (LEFT)	QUALIFIER	1720-0234	QUALIFIER	-
	XCR	M920-S47	XCR	-
LT-A400 KING QUAD ASI/ASL CAMO/FSI 11-17 (RIGHT)	QUALIFIER	1720-0233	QUALIFIER	-
	XCR	M919-S47	XCR	1723-0135
LT-A400 KING QUAD AUTO 4WD 08-10 (LEFT)	QUALIFIER	1720-0234	QUALIFIER	-
	XCR	M920-S47	XCR	-
LT-A400 KING QUAD AUTO 4WD 08-10 (RIGHT)	QUALIFIER	1720-0233	QUALIFIER	-

FITS MODEL	COMPOUND	FRONT PART #	COMPOUND	REAR PART #
BRAKE PADS & SHOES (CON'T)				
SUZUKI (CON'T)				
T-A400 KING QUAD AUTO 4WD 08-10 (RIGHT) (CON'T)	XCR	M919-S47	XCR	1723-0135
LT-A500 KING QUAD (ALL) 09-19 (LEFT)	QUALIFIER	1720-0233	QUALIFIER	-
	XCR	M919-S47	XCR	-
LT-A500 KING QUAD (ALL) 09-19 (RIGHT)	QUALIFIER	1720-0234	QUALIFIER	-
	XCR	M920-S47	XCR	-
LT-A500 VINSON 4WD 02	QUALIFIER	1720-0231	QUALIFIER	1720-0233
	XCR	M107-S47	XCR	M919-S47
LT-F500 QUADRUNNER 98-02 (LEFT)	QUALIFIER	1720-0237	QUALIFIER	-
	XCR	M411-S47	XCR	-
LT-F500 QUADRUNNER 98-02 (RIGHT)	QUALIFIER	1720-0238	QUALIFIER	-
	XCR	M412-S47	XCR	M9187
LLT-F500 VINSON 03-07 (2X4/4X4) (ALL)	QUALIFIER	1720-0229	QUALIFIER	-
	XCR	M811-S47	XCR	M310-S47
QUV 620 FK5 SIDE X SIDE	XCR	M9203	XCR	M9204
LT-A700 KINGQUAD 05-09 (LEFT)	QUALIFIER	1720-0233	QUALIFIER	-
	XCR	M919-S47	XCR	-
LT-A700 KINGQUAD 05-09 (RIGHT)	QUALIFIER	1720-0234	QUALIFIER	-
	XCR	M920-S47	XCR	-
LT-V700 TWIN PEAKS 04-05 (LEFT)	QUALIFIER	-	QUALIFIER	-
	XCR	M929-S47	XCR	-
LT-V700 TWIN PEAKS 04-05 (RIGHT)	QUALIFIER	-	QUALIFIER	-
	XCR	M326-S47	XCR	-
LT-A750 KINGQUAD 08-19 (ALL) (LEFT)	QUALIFIER	1720-0233	QUALIFIER	-
	XCR	M919-S47	XCR	-
LT-A750 KINGQUAD 08-19 (ALL) (RIGHT)	QUALIFIER	1720-0234	QUALIFIER	-
	XCR	M920-S47	XCR	-
YAMAHA				
YFM80T GRIZZLY 05-08	XCR	M9111	XCR	1723-0018
YFM100 89-91	XCR	M9111	XCR	-
YFA1 100 BREEZE 89-91	XCR	M9111	XCR	-
YFA125 BREEZE 89-95	XCR	M9111	XCR	1723-0018
YFM125 BREEZE 92-02	XCR	M9111	XCR	1723-0018
YFM125 GRIZZLY 04-13	XCR	M9111	XCR	1723-0018
YTI25 82-85	XCR	-	XCR	M841-S47
YTI75 TRI-MOTO 82-83	XCR	M9111	XCR	M841-S47
YFM200 MOTO 4 85-89	XCR	M9111	XCR	M841-S47
YTM200 TRI-MOTO 83-85	XCR	M9111	XCR	M841-S47
YTM225 TRI-MOTO 83-86	XCR	M9111	XCR	M841-S47
YFM225 MOTO 4 86-88	XCR	M9111	XCR	M841-S47
YFB250 TIMBERWOLF 2WD 92-94	XCR	M9111	XCR	M9152
YFB250 TIMBERWOLF 2WD 95-98	XCR	M9152	XCR	M9152
YFB250 TIMBERWOLF 4WD 94-96	XCR	M9152	XCR	M9152
YFM250 89-91	XCR	M9127	XCR	M841-S47
YFM250 BEAR TRACKER 01-04	QUALIFIER	1720-0231	QUALIFIER	-
	XCR	M107-S47	XCR	M9152
YFM250 BEAR TRACKER 99-00	XCR	M9152	XCR	M9152
YFM250 BIG BEAR 07-09	QUALIFIER	1720-0231	QUALIFIER	-
	XCR	M107-S47	XCR	1723-0155
YFM250 BRUIN 05-06	QUALIFIER	1720-0231	QUALIFIER	-
	XCR	M107-S47	XCR	1723-0155
YFM300 GRIZZLY 12-13	XCR	M312-S47	XCR	M310-S47
YFM350 BIG BEAR 87-88	XCR	M9164	XCR	M841-S47
YFM350 BIG BEAR 89-95	XCR	M9165	XCR	M841-S47
YFM350 BIG BEAR 96-98	XCR	M9165	XCR	M9152
YFM350 BIG BEAR 99	QUALIFIER	1720-0231	QUALIFIER	-
	XCR	M107-S47	XCR	M9152
YFM350 BRUIN 2X4/4X4 04-06	QUALIFIER	1720-0231	QUALIFIER	-
	XCR	M107-S47	XCR	1723-0155
YFM350 GRIZZLY 2X4/4X4 AUTO 07-13 (STRAIGHT AXLE)	XCR	M107-S47	XCR	1723-0155
	QUALIFIER	1720-0231	QUALIFIER	-
YFM350 GRIZZLY 4X4 IRS 07-11	QUALIFIER	1720-0231	QUALIFIER	-
	XCR	M107-S47	XCR	-
YFM350ER 87-88	XCR	M9111	XCR	M841-S47
YFM350ER 89-90/92-95	XCR	M9127	XCR	M841-S47
YFM350FX WOLVERINE 4WD 95-05	QUALIFIER	1720-0231	QUALIFIER	1720-0229
	XCR	M107-S47	XCR	M811-S47
YFM350V WOLVERINE 2WD 06-09	QUALIFIER	1720-0231	QUALIFIER	-
	XCR	M107-S47	XCR	1723-0155
YFM350X WARRIOR 89-04	QUALIFIER	1720-0231	QUALIFIER	1720-0229
	XCR	M107-S47	XCR	M811-S47
YFM350XT WARRIOR 87-88	QUALIFIER	-	QUALIFIER	1720-0229



BRAKE DRUM SEALS

Direct replacements of the original seal.

FITS MODEL	COMPOUND	FRONT PART #	COMPOUND	REAR PART #
BRAKE PADS & SHOES (CON'T)				
YAMAHA (CON'T)				
YFM350XT WARRIOR 87-88 (CON'T)	XCR	-	XCR	M811-S47
YFM400 BIG BEAR 00-04 (ALL)	QUALIFIER	1720-0231	QUALIFIER	-
	XCR	M107-S47	XCR	M9132
YFM400 GRIZZLY 4X4 07-08	QUALIFIER	1720-0231	QUALIFIER	1720-0239
	XCR	M107-S47	XCR	M327-S47
YFM400 GRIZZLY 4X4 IRS 07-10	QUALIFIER	1720-0231	QUALIFIER	-
	XCR	M107-S47	XCR	-
YFM400 KODIAK 00-02	QUALIFIER	1720-0231	QUALIFIER	1720-0239
	XCR	M107-S47	XCR	M327-S47
YFM400 KODIAK 05	QUALIFIER	1720-0231	QUALIFIER	1720-0239
	XCR	M107-S47	XCR	M327-S47
YFM400 KODIAK 2X4/4X4 03-04	QUALIFIER	1720-0231	QUALIFIER	-
	XCR	M107-S47	XCR	-
YFM400 KODIAK 93-98	XCR	M9165	XCR	M9132
YFM400F BIG BEAR 4X4 05-06	QUALIFIER	1720-0231	QUALIFIER	-
	XCR	M107-S47	XCR	1723-0155
YFM400FWL KODIAK 00-02	QUALIFIER	1720-0231	QUALIFIER	1720-0239
	XCR	M107-S47	XCR	M327-S47
YFM450 GRIZZLY 4X4 07-10	QUALIFIER	1720-0231	QUALIFIER	1720-0239
	XCR	M107-S47	XCR	M327-S47
YFM450 GRIZZLY AUTO 4X4 08-12	QUALIFIER	1720-0231	QUALIFIER	1720-0239
	XCR	M107-S47	XCR	M327-S47
YFM450 GRIZZLY AUTO 4X4 IRS 07	QUALIFIER	1720-0231	QUALIFIER	1720-0239
	XCR	M107-S47	XCR	M327-S47
YFM450 GRIZZLY AUTO/4X4/EPS 11-14	QUALIFIER	1720-0229	QUALIFIER	-
	XCR	M811-S47	XCR	-
YFM450 KODIAK 03-06	QUALIFIER	1720-0231	QUALIFIER	1720-0239
	XCR	M107-S47	XCR	M327-S47
YFM450 KODIAK IRS 06	QUALIFIER	1720-0231	QUALIFIER	1720-0239
	XCR	M107-S47	XCR	M327-S47
YFM450 WOLVERINE 06-10	QUALIFIER	1720-0231	QUALIFIER	1720-0239
	XCR	M107-S47	XCR	M327-S47
YXR450 RHINO 06-09 (LEFT)	QUALIFIER	1720-0238	QUALIFIER	-
	XCR	M412-S47	XCR	-
YXR450 RHINO 06-09 (RIGHT)	QUALIFIER	1720-0237	QUALIFIER	-
	XCR	M411-S47	XCR	1721-0837
YFM550 4WD EPS GRIZZLY AUTO FI 09-14 (LEFT)	XCR	1721-0749	XCR	1721-0751
YFM550 4WD EPS GRIZZLY AUTO FI 09-14 (RIGHT)	XCR	1721-0750	XCR	1721-0752
YFM550 4WD GRIZZLY AUTO FI 09-14 (LEFT)	XCR	1721-0749	XCR	1721-0751
YFM550 4WD GRIZZLY AUTO FI 09-14 (RIGHT)	XCR	1721-0750	XCR	1721-0752
YFM600 GRIZZLY 98-01 (ALL)	QUALIFIER	1720-0229	QUALIFIER	-
	XCR	M811-S47	XCR	M9132
YFM660F GRIZZLY 02-08 (ALL)	QUALIFIER	1720-0229	QUALIFIER	-
	XCR	M811-S47	XCR	M930-S47
YXR660 RHINO 4X4 04-07 (LEFT)	QUALIFIER	1720-0238	QUALIFIER	-
	XCR	M412-S47	XCR	-
YXR660 RHINO 4X4 04-07 (RIGHT)	QUALIFIER	1720-0237	QUALIFIER	-
	XCR	M411-S47	XCR	1721-0837
YFM700 GRIZZLY 07-19 (LEFT) (ALL)	XCR	1721-0749	XCR	1721-0752
YFM700 GRIZZLY 07-19 (RIGHT) (ALL)	XCR	1721-0750	XCR	1721-0751
YFM700 KODIAK 4WD/EPS 16-19 (LEFT)	XCR	1721-0749	XCR	-
YFM700 KODIAK 4WD/EPS 16-19 (RIGHT)	XCR	1721-0750	XCR	-
YXE700 WOLVERINE (ALL) 16-18 (LEFT)	XCR	1721-1889	XCR	1721-1891
YXE700 WOLVERINE (ALL) 16-18 (RIGHT)	XCR	1721-1888	XCR	1721-1890
YXM700 VIKING (ALL) 14-18 (LEFT)	XCR	1721-1889	XCR	1721-1891
YXM700 VIKING (ALL) 14-19 (RIGHT)	XCR	1721-1888	XCR	1721-1890
YXR700 RHINO 08-09/11-13 (LEFT)	QUALIFIER	1720-0238	QUALIFIER	-
	XCR	M412-S47	XCR	-
YXR700 RHINO 08-09/11-13 (RIGHT)	QUALIFIER	1720-0237	QUALIFIER	1720-0237
	XCR	M411-S47	XCR	M411-S47
YXZ1000R 14-19	XCR	1721-2492	XCR	1721-2493

FITS MODEL	FRONT PART #	REAR PART #
BRAKE DRUM SEALS		
HONDA		
TRX90 93-19	-	A30-7601
TRX200, TRX200D 90-91	-	A30-7601
TRX200, TRX200D 96-97	-	A30-7601
TRX200D 92-95	-	A30-7601
TRX200SX 87	-	A30-7601
ATC250ES 85-87	-	A30-6701
ATC250SX 85-87	-	A30-6701
TRX250 FOURTRAX 85-87	-	A30-6701
TRX300 FOURTRAX 88-00	1730-0003	A30-7601
TRX300FW FOURTRAX 4X4 88-00	1730-0006	A30-7601
TRX350D 87	-	A30-6701
TRX350D 88-89	1730-0006	A30-6701
TRX350FE 00-06	1730-0009	A30-7602
TRX350FM FOURTRAX RANCHER 00-06	1730-0009	A30-7602
TRX350TE 00-06	1730-0009	A30-7602
TRX350TM RANCHER 00-06	1730-0009	A30-7602
TRX400FA 04-07	1730-0009	A30-7602
TRX400FGA FOURTRAX RANCHER 4X4 04-07	1730-0009	A30-7602
TRX400FW FOURTRAX FOREMAN 4X4 95-01	1730-0006	A30-7602
TRX400FW FOURTRAX FOREMAN 4X4 02-03	1730-0009	A30-7602
TRX420FA 15-19	-	A30-7602
TRX420 FE 14-19	-	A30-7602
TRX420 FM 14-19	-	A30-7602
TRX420 TE 14-19	-	A30-7602
TRX420 TM 14-19	-	A30-7602
TRX450ES 98-01	1730-0006	A30-7602
TRX450FE/FM 02-04	1730-0009	A30-7602
TRX450S 98-01	1730-0006	A30-7602
TRX500FA 01-04	1730-0009	A30-7602
TRX500FA 05-14	-	A30-7602
TRX500FE 05-19	-	A30-7602
TRX500FGA 04	1730-0009	A30-7602
TRX500FGA 05-09	-	A30-7602
TRX500FM 05-11	-	A30-7602
TRX500FPA 09-14	-	A30-7602
TRX500FPE 08-11	-	A30-7602
TRX500FPM 08-11	-	A30-7602
TRX500TM 05-06	-	A30-7602
TRX650 RINCON 03-05	1730-0009	-
SUZUKI		
LT-4WD 250 87-88	-	1730-0007
LT-4WD 250 89-98	1730-0004	1730-0007
LT-F250 88-01	1730-0004	1730-0007
LT-F4WD 250 97-98	1730-0004	1730-0007
LT-F300F KING QUAD 99-02	-	1730-0001
LT-F4WDX KING QUAD 300 91-94	-	1730-0001
LT-F4WDX KING QUAD 300 95-98	-	1730-0001
LT-A400 2WD KING QUAD 08-09	-	1730-0002
LT-A400 EIGER 02-07	-	1730-0002
LT-A400F 4WD KING QUAD 08-18	-	1730-0002
LT-A500F QUAD MASTER AUTO 00-01	-	1730-0001
LT-F500F QUAD MASTER 00-01	-	1730-0001
LT-F500F QUAD RUNNER 98-99	-	1730-0001
LT-F500F VINSON 02	-	1730-0001
YAMAHA		
YFB250 TIMBERWOLF 92-94	-	A30-19401
YFB250 TIMBERWOLF 95-98	A30-19401	A30-19401
YFB250FW TIMBERWOLF 94-00	A30-19401	A30-19401
YFM250 BEARTRACKER 99-04	A30-19401	A30-19401
YFM250 MOTO-4 89-91	A30-19401	-
YFM350ER MOTO-4 90-95	A30-19401	-
YFM350FW BIG BEAR 89-95	A30-19401	-
YFM350FW BIG BEAR 96-98	A30-19401	A30-19401
YFM350FW BIG BEAR 99	-	A30-19401
YFM350U BIG BEAR 96-98	A30-19401	A30-19401
YFM350U BIG BEAR 99	-	A30-19401
YFM400 KODIAK 4WD 93-98	A30-19401	A30-19401
YFM400 KODIAK 4WD 99	-	A30-19401
YFM600 GRIZZLY 98-01	-	A30-19401

FRONT BRAKE CALIPER PISTONS

Kit includes required quantities of brake caliper pistons.



FITS MODEL	FRONT PART #	QTY
FRONT BRAKE CALIPER PISTONS		
HONDA		
TRX420 07-16	1702-0184	1
TRX500FA/FPA 05-14	1702-0186	1
TRX500FA/FPA 15-16	1702-0184	1
TRX500FE/FM/FPE 05-11	1702-0184	1
TRX500FE/FM/FPE 12-16	1702-0184	1
TRX680 06-16	1702-0186	1
KAWASAKI		
KVF300/4X4 99-02	1702-0189	1
KVF360/4X4 03-12	1702-0189	1
KVF400/4X4 97-02	1702-0189	1
KLF400 93-99	1702-0183	2
KVF650 06-13	1702-0183	2
KVF750 05-16	1702-0183	2
SUZUKI		
LT-F250 02-14	1702-0187	1
LT-F300F 99-02	1702-0185	2
LT-A400/F 02-07	1702-0187	1
LT-F400/F 02-07	1702-0187	1
LT-A400/F 08-15	1702-0188	1
LT-F400/F 08-15	1702-0188	1
LT-A450X 07-10	1702-0188	1
LT-A500F 00-01	1702-0183	2
LT-F500 98-02	1702-0183	2
LT-A500F 02-07	1702-0187	1
LT-F500F 03-07	1702-0187	1
LT-A500X/XP 09-15	1702-0188	1
LT-A700X 06-07	1702-0188	1
LT-A750X 08-15	1702-0188	1
YAMAHA		
YFM250R 08-13	1702-0188	1
YFM250B 05-09	1702-0187	1
YFM250X 01-04	1702-0187	1
YFM350A/FA 04-06	1702-0187	1
YFM350B 05-06	1702-0187	1
YFM350F/U 99	1702-0187	1
YFM350FG/G 07-13	1702-0187	1
YFM350FX 95-05	1702-0187	1
YFM350R 04-13	1702-0187	1
YFM350X 89-04	1702-0187	1
YFM350X 06-09	1702-0187	1
YFM400 00-04	1702-0187	1
YFM400A 00-04	1702-0187	1
YFM400F 00-12	1702-0187	1
YFM400FA 99-06	1702-0187	1
YFM450FA 03-06	1702-0187	1
YFM450FG 07-13	1702-0187	1
YFM450FX 06-10	1702-0187	1
YFM550FG 09-13	1702-0188	1
YFM550DE/DH/PE/PH 14	1702-0188	1
YFM600 98-01	1702-0187	1
YFM660F 02-08	1702-0187	1
YFM700R 06-15	1702-0185	2
YFM700FG 07-13	1702-0188	1
YFM700DE/DH/PE/PH 14-15	1702-0188	1
YFM700DF/PF 15	1702-0188	1
YFM700GD/GP 16	1702-0188	1
YFM700KD/KP 16	1702-0188	1
RHINO 450 06-09	1702-0244	1
RHINO 660 04-07	1702-0244	1
RHINO 700 08-13	1702-0244	1

REAR BRAKE CALIPER PISTONS

Kit includes required quantities of brake caliper pistons.



FITS MODEL	FRONT PART #	REAR PART #	QTY
REAR BRAKE CALIPER PISTONS			
KAWASAKI			
KSF250 87-04		1702-0192	1
KXF250 87-88		1702-0192	1
KEF300 95-03		1702-0192	1
KSF450 08-09		1702-0192	1
SUZUKI			
LT-A500F 02-03		1702-0193	1
YAMAHA			
YFM400A 00-01		1702-0193	1
YFM400FA 00-06		1702-0193	1
YF2450 04-05		1702-0190	1
YFM450FA 03-06		1702-0193	1
YFM450FG 07		1702-0193	1
YFM450FX 06-10		1702-0193	1
YFM550FG 09-13		1702-0195	1
YFM550DE/DH/PE/PH 14		1702-0195	1
YFM660R 01-05		1702-0190	1
YFM700FG 07-13		1702-0195	1
YFM700DE/DH/PE/PH 14-15		1702-0195	1
YFM700DF/PF 15		1702-0195	1
YFM700R 06-12		1702-0197	1



MASTER CYLINDER REPAIR KITS

Complete kits to rebuild the master cylinders. Each kit contains all necessary components.

FITS MODEL	FRONT PART #	REAR PART #
MASTER CYLINDER REPAIR KITS		
HONDA		
TRX200 FOURTRAX 84	MD06-001	-
TRX200 FOURTRAX 90-91	MD06-001	-
TRX200D FOURTRAX 91-97	MD06-001	-
TRX200SX FOURTRAX 86-88	MD06-001	-
TRX250 FOURTRAX 85-86	MD06-001	-
TRX250 RECON 97-01	MD06-001	-
TRX250TE/TM 02-16	MD06-001	-
TRX300 FOURTRAX 88-99	MD06-001	-
TRX300 FOURTRAX 00	MD06-003	-
TRX300FW FOURTRAX 88-00	MD06-003	-
TRX350 RANCHER 00-03	MD06-001	-
TRX350 RANCHER 4X4 00-03	MD06-001	-
TRX350/D FOURTRAX 86-87	MD06-001	-
TRX350 04-06	0617-0090	-
TRX400FW FOREMAN 95-03	MD06-003	-
TRX400 04-07	0617-0090	-
TRX420 07-08	0617-0090	-
TRX450 FOREMAN 98-01	MD06-003	-
TRX500 01-03	MD06-003	-
TRX500FA/FGA 04	MD06-003	-
TRX500 05-08	0617-0090	-
TRX500FA/FGA 05-08	0617-0090	-
TRX650 03-07	0617-0090	0617-0093
TRX680 06-15	-	0617-0093
KAWASAKI		
KVF300 PRAIRIE 4X4 99-02	MD06-202	-
KVF300 PRAIRIE 99-02	MD06-202	-
KLF300 BAYOU 4X4 89-04	MD06-202	-

FITS MODEL	FRONT PART #	REAR PART #
MASTER CYLINDER REPAIR KITS (CON'T)		
KAWASAKI (CON'T)		
KLF300 BAYOU 86-04	MD06-202	-
KVF360 03-12	MD06-202	-
KVF400/4X4 PRAIRIE 97-02	MD06-202	-
KLF400 BAYOU 93-99	MD06-202	-
KVF650 PRAIRIE 02-03	MD06-202	-
KVF650D/E 05-13	MD06-202	-
KVF650F/H 07-13	0617-0091	-
KSV700 04-09	MD06-202	-
KVF700 PRAIRIE 04-06	MD06-202	-
KVF750 05-16	0617-0091	-
SUZUKI		
LT230E QUADRUNNER 87-93	MD06-201	MD06-051
LT230GE QUADRUNNER 85-86	MD06-201	-
LT230S QUADSPORT 85-88	MD06-201	MD06-051
LT230 QUADRUNNER 86-87	MD06-201	-
LT250E/EF QUADRUNNER 85-86	MD06-202	-
LT250R QUADRACER 85-92	MD06-201	MD06-051
LT250 OZARK 03-08	MD06-202	-
LT250F QUADRUNNER 88-14	MD06-202	-
LT300E QUADRUNNER 87-89	MD06-201	-
LT300F KING QUAD 99-02	MD06-202	-
LT4WD QUADRUNNER 87	MD06-201	-
LT4WD QUADRUNNER 88-96	MD06-202	-
LT4WD QUADRUNNER 97-98	MD06-202	-
LT4WDX KING QUAD 91-98	MD06-202	-
LTA400/F 02-14	MD06-202	-
LTF400/F 02-14	MD06-202	-
LTA450X 07-10	MD06-202	-
LTA500F 06-07	-	MD06-051
LTA500F QUAD MASTER 00-01	MD06-202	-
LTA500F VINSION 02-07	MD06-202	-
LTA500X 11-15	MD06-202	-
LTA500XP 09-15	MD06-201	-
LTF500F 03-07	-	MD06-051
LTF500F QUADRUNNER 98-07	MD06-202	-
LTA700X 05-07	MD06-202	-
LTA750X 08-14	MD06-202	-
LTA750XP 09-15	MD06-201	-
YAMAHA		
YFM250B 05-09	0617-0092	-
YFM350/FW BIG BEAR 87-98	MD06-301	-
YFM350A/G 04-11	0617-0092	-
YFM350F/U BIG BEAR 99	MD06-302	-
YFM350FA/FG 04-13	0617-0092	-
YFM350FX 02-05	0617-0092	-
YFM350FX WOLVERINE 96-01	MD06-301	-
YFM350R 04-13	0617-0041	0617-0095
YFM350T/D 14	0617-0092	-
YFM350U BIG BEAR 96-98	MD06-301	-
YFM350X 02-04	0617-0041	-
YFM350X 06-09	0617-0092	-
YFM400 BIG BEAR 00-01	MD06-301	-
YFM400A 03-04	0617-0092	-
YFM400F 02-08	0617-0092	-
YFM400F 99	MD06-302	-
YFM400F/FW KODIAK 93-99	MD06-301	-
YFM400FA 02-06	0617-0092	0617-0060
YFM450FA/FG 03-13	0617-0092	0617-0060
YFM450D/P 14	0617-0092	-
YFM400FB 02-12	0617-0092	-
YFM400FG 07-08	-	0617-0060
YFM450FG 07	-	0617-0060
YFM450FX 06-08	0617-0092	0617-0060
YFM450FX 09-10	0617-0092	0617-0060
YFM600 GRIZZLY 98-01	MD06-302	-
YFM700FG 07	0617-0041	-
YFM700FG 12	0617-0237	-
RHINO 660 04-07	-	0617-0194





FRONT & REAR BRAKE CALIPER REBUILD KITS

Each kit includes all necessary rubber components and pad hanger pins if applicable.



FITS MODEL	FRONT PART #
FRONT BRAKE CALIPER REBUILD KITS	
HONDA	
TRX420 07-16	1702-0065
FOREMAN 500 05-11	1702-0067
TRX500 FOREMAN 12-16	1702-0065
RUBICON 500 05-14	1702-0067
TRX500 RUBICON 15-16	1702-0065
TRX680 06-16	1702-0067
KAWASAKI	
KVF300/4X4 99-02	1702-0072
KVF360/4X4 03-12	1702-0072
KLF400 93-99	1702-0071
KVF400/4X4 97-02	1702-0072
KVF650 06-13	1702-0071
KRF750 08-09	1702-0071
KVF750 05-14	1702-0071
SUZUKI	
LTF250 02-14	1702-0073
LTA400/F 02-07	1702-0073
LTF400/F 02-07	1702-0073
LTA400/F 08-15	1702-0074
LTF400/F 08-15	1702-0074
LTA450X 07-10	1702-0074
LTA500F 02-07	1702-0073
LTA500X 11-15	1702-0074
LTF500F 03-07	1702-0073
LTA500F 00-01	1702-0075
LTF500F 98-02	1702-0075
LTA700X 06-07	1702-0074
LTA750X 08-15	1702-0074
YAMAHA	
YFM250B 05-09	1702-0233
YFM250X 01-04	1702-0233
YFM350 BRUIN 04-06	1702-0233
YFM350FG/G 07-12	1702-0233
YFM400/F 00-12	1702-0233
YFM400A/FA 99-06	1702-0233
YFM450FA 03-06	1702-0233
YFM450FG 07-12	1702-0233
YFM550FG 09-13	1702-0077
YFM550DE/PE 14	1702-0077
YFM600 98-01	1702-0233
YFM700FG 07-13	1702-0077
YFM700DE/DH/PE/PH 14-15	1702-0077
YFM700DF/PF 15	1702-0077
RHINO 450 06-09	1702-0243
RHINO 660 04-07	1702-0243
RHINO 700 08-13	1702-0243

FITS MODEL	REAR PART #
REAR BRAKE CALIPER REBUILD KITS	
YAMAHA	
YFM400A 00-01	1702-0083
YFM400FA 00-06	1702-0083
RHINO 450 06-09	1702-0086
YFM450FA 03-06	1702-0083
YFM450FG 07	1702-0083
YFM550FG 09-13	1702-0084
YFM550DE/DH/PE/PH 14	1702-0084
RHINO 660 04-07	1702-0086
YFM660F 02-08	1702-0085
YFM700FG 07-13	1702-0084
YFM700DE/DH/PE/PH 14-15	1702-0084
YFM700DF/PF 15	1702-0084
YFM700GD/GP 16	1702-0077
YFM700KD/KP 16	1702-0077



FRONT & REAR BRAKE CALIPER PINS

Each kit includes required quantities of brake pad hanger pins.

FITS MODEL	FRONT PART #
FRONT BRAKE CALIPER PINS	
HONDA	
TRX420 07-16	1702-0106
KAWASAKI	
KVF300/4X4 99-02	1702-0108
KVF360/4X4 03-12	1702-0108
KVF400/4X4 97-02	1702-0108
KLF400 93-99	1702-0106
KVF650 06-13	1702-0106
KVF750 05-16	1702-0106
SUZUKI	
LTF250 02-14	1702-0106
LTA400/F 02-07	1702-0106
LTF400/F 02-07	1702-0106
LTA400/F 08-15	1702-0109
LTF400/F 08-15	1702-0109
LTA450X 07-10	1702-0109
LTA500F 00-07	1702-0106
LTA500X 11-15	1702-0109
LTF500F 98-07	1702-0106
LTA700X 06-07	1702-0109
LTA750X 08-15	1702-0109
YAMAHA	
YFM250B 05-09	1702-0106
YFM250X 01-04	1702-0106
YFM350 BRUIN 04-06	1702-0106
YFM350F/U 99	1702-0106
YFM350FG/G 07-13	1702-0106
YFM350FX 95-05	1702-0106
YFM350R 04-13	1702-0106
YFM350X 89-04	1702-0106
YFM350X 06-09	1702-0106
YFZ350 90-06	1702-0106
YFM400/F 00-12	1702-0106
YFM400A/FA 99-06	1702-0106
YFM450FA 03-06	1702-0106
YFM450FG 07-13	1702-0106
YFM450FX 06-10	1702-0106
YFM550FG 09-13	1702-0107
YFM550DE/DH/PE/PH 14	1702-0107
YFM600 98-01	1702-0106
YFM660F 02-08	1702-0106
YFM660R 01-05	1702-0106
YFM700FG 07-13	1702-0107
YFM700DE/DH/PE/PH 14-15	1702-0107
YFM700DF/PF 15	1702-0107
YFM700GD/GP 16	1702-0107
YFM700KD/KP 16	1702-0107

FITS MODEL	REAR PART #
REAR BRAKE CALIPER PINS	
KAWASAKI	
KSF250 87-04	1702-0108
KEF300 95-03	1702-0108
KSF450 08-14	1702-0108
YAMAHA	
YFM400A 00-01	1702-0110
YFM400FA 00-06	1702-0110
YFM450FA 03-06	1702-0110
YFM450FG 07	1702-0110
YFM450FX 06-10	1702-0110





PLOWS

WINCHES

UTV

RACKS

IMPLEMENTS
& TOWING

LUGGAGE

BODY

CONTROLS

ELECTRICAL

WHEELS
& TIRES

SUSPENSION
& DRIVE

BRAKING

ENGINE

RIDER

GARAGE

PROMO

ENGINE

OIL FILTERS

High-quality replacement for your standard filter. Manufactured with sealing ring to ensure perfect fit. Can filter down to 10 microns. Offers maximum protection and long lasting filter life. May be used with conventional and synthetic oils.



FITS MODEL	PART #
OIL FILTERS	
ARCTIC CAT	
250 99-05	0712-0279
300 2X4, 4X4 98-05	0712-0279
350/366 10-11	0712-0272 ¹
400 2X4, 4X4/AUTO 98-08	0712-0280 ¹
425 CR 11-13	0712-0272 ¹
450 ATV/TRV 11-13	0712-0272 ¹
454 2X4, 4X4 96-98	0712-0280 ¹
500 4X4 AUTO 96-98	0712-0280 ¹
500 4X4 AUTOTRV 08-09	0712-0272 ¹
550 HI/TRV 09-14	0712-0272 ¹
600 4X4, LE 04	0712-0277 ¹
650 HI 4X4, AUTO LE, TBX, TRV PLUS, LE 07-12	0712-0272 ¹
650 PROWLER HI/XT 06-12	0712-0272 ¹
650 V-TWIN 4X4 AUTO, AUTO LE 04-06	0712-0277 ¹
700 EFI 4X4 AUTO, M4 TRV LE 08-09	0712-0272 ¹
700 HI/XT/TRV EFI 4X4 AUTO SE 08-13	0712-0272 ¹
THUNDERCAT 1000 08-09	0712-0272 ¹
ATV1000 4X4, TRV CRUISER/MUD PRO 08-15	0712-0272 ¹
CAN-AM	
330 OUTLANDER 04-05	0712-0357
400 OUTLANDER 04-09	0712-0357
500 EFI/XT OUTLANDER 08-15	0712-0357
650 EFI/XT/MAX OUTLANDER 06-15	0712-0357
800 EFI/XT/MAX OUTLANDER 06-15	0712-0357
800 X RENEGADE 07-15	0712-0357
DLI	
450 DL901 05-06	0712-0221
450 DL901 DMX 07-08	0712-0221
450 DL902 (ALL)	0712-0221
460 DL 904 DMX 08-	0712-0221
HONDA	
TRX200 D/ FOURTRAX 89-98	0712-0221
ATC250X/ATC 250ES 85-87	0712-0221
TRX300 ZWD 88-98	0712-0221
TRX300/300FW 4X4 87-01	0712-0221
TRX350 RANCHER ALL 00-06	0712-0221
TRX350/D FOURTRAX/FOREMAN 86-89	0712-0221
TRX400/450 FOURTRAX/FOREMAN 95-08	0712-0221
TRX400 RANCHER AT 04-07	0712-0274
TRX400 EX 99-14	0712-0221
TRX420 FE/FM 07-16	0712-0221
TRX420 FPA/FPE/FPM RANCHER 09-16	0712-0221
TRX420 TE/TM RANCHER 07-16	0712-0221
TRX500 RUBICON, FOURTRAX 01-14	0712-0274
TRX500 FOREMAN 05-16	0712-0221
TRX650 RINCON 03-05	0712-0274
TRX680 RINCON 06-16	0712-0274
KAWASAKI	
KLT200 80-84	0712-0276
KLF220 BAYOU 88-02	0712-0276
KLF250 BAYOU 03-09	0712-0276
KLF300 BAYOU 86-05	0712-0276
KVF300 PRAIRIE 99-02	0712-0278 ¹
KVF360 PRAIRIE ALL 02-14	0712-0277 ¹
KLF400 BAYOU 93-98	0712-0278 ¹
KVF400 PRAIRIE 97-02	0712-0278 ¹
KAF450/540 MULE ALL	0712-0278 ¹
KVF650 BRUTE FORCE, PRAIRIE ALL	0712-0277 ¹
KFX700 / V-FORCE 04-09	0712-0277 ¹
KVF700 PRAIRIE 04-06	0712-0277 ¹
KVF750 BRUTE FORCE/4X4 05-16	0712-0277 ¹
KRF750 TERYX 4X4/ 4X4 LE 08-13	0712-0277 ¹
KYMCO	
MXU 500 06-15	0712-0542
UXV 500 08-15	0712-0542
MXU 550 11-12	0712-0542
MXU 700 13	0712-0542
MAXXER 375	0712-0280 ¹
MXU 375	0712-0280 ¹
MXU	0712-0280 ¹
MAXXER 450I	0712-0280 ¹
MXU 450I	0712-0280 ¹

FITS MODEL	PART #
OIL FILTERS (CON'T)	
POLARIS	
300 HAWKEYE 06-07	0712-0278 ¹
300 SPORTSMAN 08-09	0712-0278 ¹
325 MAGNUM, TRAIL BOSS, XPEDITION 00-02	0712-0278 ¹
330 ATP, MAGNUM, TRAIL BOSS, HAWK 03-13	0712-0278 ¹
330 TRAIL BLAZER 08-13	0712-0278 ¹
335 SPORTSMAN 99-01	0712-0278 ¹
400 RANGER 10-14	0712-0278 ¹
400 SPORTSMAN 01-05	0712-0278 ¹
400 SPORTSMAN/HAWKEYE 08-13	0712-0278 ¹
440L XPLODER 96-01	0712-0278 ¹
425 MAGNUM 2X4 4X4 6X6 95-98	0712-0278 ¹
425 XPEDITION 00-02	0712-0278 ¹
450 SPORTSMAN 06-07	0712-0278 ¹
500 ATP 04-05	0712-0278 ¹
500 RANGER 06-09	0712-0278 ¹
500 SPORTSMAN HO 6X6 X2/X2 EFI HO 00-09	0712-0278 ¹
500 EXPLORER 4X4 06-09	0712-0278 ¹
550 SPORTSMAN 09-12	0712-0278 ¹
570 SPORTSMAN ACE 15-16	0712-0273 ¹
570 RZR EFI 12-16	0712-0273 ¹
570 RANGER EFI/CREW/FULL SIZE 14-16	0712-0273 ¹
600 SPORT TWIN (BUILT AFTER 10/02/03) 04-05	0712-0273 ¹
700 RANGER 6X6 EFI/ CREW HD/XP 05-10	0712-0273 ¹
700 SPORTSMAN TWIN, EFI 04-09	0712-0273 ¹
800 SPORTSMAN EFI, X2, TWIN 05-14	0712-0273 ¹
800 RANGER RZR 08-15	0712-0273 ¹
850 SPORTSMAN 09-15	0712-0278 ¹
900 RZR 11-14	0712-0278 ¹
SUZUKI	
LT60 ALL 91-04	0712-0279
LT230 ALL 85-93	0712-0279
LT/LT-F 4WD ALL 87-99	0712-0279
LT250 85-86	0712-0279
LT250 88-02	0712-0279
LT250 OZARK 02-14	0712-0279
LT300E ALL 87-89	0712-0279
LT300 KING QUAD 00-02	0712-0279
LT-F400 EIGER ALL 02-07	0712-0280 ¹
LT-A400 EIGER ALL 02-07	0712-0280 ¹
LT-A400F K7 EIGER 4X4 AUTO 07	0712-0280 ¹
LT-A400F KINGQUAD AUTO 4 X 4/CAMO 08-12	0712-0280 ¹
LT-F400F KINGQUAD 4X4/CAMO 08-12	0712-0280 ¹
LT-A450X K7 KING QUAD 4X4 07-11	0712-0280 ¹
LT-A/LT-F500 QUADRUNNER/VINSON ALL	0712-0280 ¹
LTA700 KING QUAD 05-08	0712-0277 ¹
LTV700F-K4 TWIN PEAKS 04-05	0712-0280 ¹
LT-A750X KING QUAD 08-12	0712-0280 ¹
YAMAHA	
YTM200/225/250 ALL	0712-0281
YFB230/250 ALL	0712-0281
YFM250 BIG BEAR/BRUIN ALL	0712-0281
YFM350 87-07	0712-0283
YFM350 BRUIN AUTO 04-06	0712-0278 ¹
YFM350 GRIZZLY 07-13	0712-0277 ¹
YFM350 WOLVERINE 06-09	0712-0277 ¹
YFM400 GRIZZLY 07	0712-0277 ¹
YFM400 KODIAK 94-99	0712-0283
YFM400 KODIAK 00-06	0712-0278 ¹
YFM400 BIG BEAR 93-12	0712-0283
YFM450 GRIZZLY 07-14	0712-0277 ¹
YFM450 KODIAK 03-06	0712-0278 ¹
YFM450 WOLVERINE 06	0712-0278 ¹
YFM450 WOLVERINE 08-10	0712-0277 ¹
YFM550F GRIZZLY 09-13	0712-0277 ¹
YFM600 GRIZZLY 98-01	0712-0282
YFM660 GRIZZLY ALL 02-07	0712-0278 ¹
YFM660 F-W GRIZZLY AUTO 4X4 07-08	0712-0277 ¹
YXR660 RHINO 04-06	0712-0278 ¹
YFM700 GRIZZLY 07-15	0712-0277 ¹
YFM700 GRIZZLY 16-17	0712-0542 ¹
YFM700 KODIAK 16-17	0712-0542 ¹
¹ SPIN ON FILTER	

MAGNETIC ENGINE DRAIN PLUGS

Made of 7075 lightweight aluminum. Prolong engine life by pulling metal filings out of the oil. Ultra powerful magnets. Comes with either O-ring or washer sealing surface. Anodized red, unless noted. Made in the USA.



FITS MODEL	PART #
MAGNETIC ENGINE DRAIN PLUGS	
KAWASAKI	
KLF220 BAYOU 88-11	0920-0040
KLF300 BAYOU 86-04	0920-0040
KEF300 LAKOTA 95-02	0920-0040
KVF300 PRAIRIE 99-02	0920-0040
KVF360 PRAIRIE 03-11	0920-0040
KLF400 BAYOU 93-99	0920-0040
KVF650 PRAIRIE 02-03	0920-0040
KVF650 BRUTE FORCE ALL YEARS	0920-0040
KVF700 PRAIRIE 04-06	0920-0040
KFX700 ALL YEARS	0920-0040
KVF750 BRUTE FORCE 05-11	0920-0040
SUZUKI	
LT400 EIGER 02-10	0920-0044 ¹
KING QUAD 700 05-08	0920-0044 ¹
LTV700 TWIN PEAKS 04-05	0920-0040
LTA750 08-10	0920-0040
YAMAHA	
YFM350 WOLVERINE 94-10	0920-0043
GRIZZLY400 07	0920-0043
YFM400 KODIAK 00-06	0920-0043
GRIZZLY 450 07-10	0920-0043
WOLVERINE 450 08-10	0920-0043
KODIAK 450 03-06	0920-0043
YFZ450 ALL YEARS	0920-0039
RHINO 450 ALL YEARS	0920-0043
RHINO 660 ALL YEARS	0920-0042
YFM660 GRIZZLY 98-06	0920-0043
¹ COLOR IS SILVER	
FRONT & REAR MAGNETIC DIFFERENTIAL DRAIN PLUGS	
MAGNETIC DIFFERENTIAL DRAIN PLUGS	
Made of 7075 lightweight aluminum. Prolong differential life by pulling metal filings out of the oil. Ultra powerful magnets. Comes with either O-ring or washer sealing surface. Anodized red, unless noted. Made in the USA.	
	
FITS MODEL	PART #
FRONT DIFFERENTIAL MAGNETIC DRAIN PLUGS	
KAWASAKI	
PRAIRIE 360 03-11	0920-0044 ¹
PRAIRIE 650 02-03	0920-0044 ¹
PRAIRIE 700 04-06	0920-0044 ¹
BRUTE FORCE 750 05-11	0920-0044 ¹
YAMAHA	
YFM350 WOLVERINE 94-10	0920-0044 ¹
KODIAK 400 93-99	0920-0044 ¹
GRIZZLY 660 98-01	0920-0039
FRONT DIFFERENTIAL MAGNETIC DRAIN PLUGS	
FITS MODEL	PART #
REAR DIFFERENTIAL MAGNETIC DRAIN PLUGS	
SUZUKI	
KING QUAD 700 05-08	0920-0043
TWIN PEAKS 700 04-05	0920-0044 ¹
LTA750 08-10	0920-0043
YAMAHA	
KODIAK 450 03-06	0920-0043
GRIZZLY 450 07-10	0920-0043
WOLVERINE 450 06-10	0920-0043
RHINO 450/660 ALL YEARS	0920-0039
GRIZZLY 660 98-08	0920-0043
GRIZZLY 700 07-10	0920-0043
¹ COLOR IS SILVER	

CAM CHAINS

Made from the highest-quality select-steel alloys. Lightweight and durable. Feature precision solid bushings and shot-peened, providing maximum strength. Made to meet or exceed OEM standards.



FITS MODEL	DESCRIPTION	PART #
CAM CHAINS		
HONDA		
ATC90/K1/K2/K3 76-78	25H X 86 LINKS	0925-0813
ATC110 79-85	25H X 88 LINKS	0925-0814
ATC185 80	25H X 100 LINKS	0925-0815
ATC185S 81-83	25H X 100 LINKS	0925-0815
ATC200 /E/ES/M/S/X 81-87	25H X 100 LINKS	0925-0815
TRX200 /D FOURTRAX 90-97	25H X 100 LINKS	0925-0815
TRX200 FOURTRAX 84	25H X 100 LINKS	0925-0815
TRX200SX FOURTRAX SX 86-88	25H X 100 LINKS	0925-0815
ATC250ES BIG RED 85-87	82RH2015 X 110 LINKS	0925-0817
ATC250SX 85-87	82RH2015 X 110 LINKS	0925-0817
TRX250 FOURTRAX 250 85-87	82RH2015 X 110 LINKS	0925-0817
TRX300 FOURTRAX 88-00	92RH2010 X 110 LINKS	0925-0807
TRX300FW 4X4 FOURTRAX 88-00	92RH2010 X 110 LINKS	0925-0807
ATC350X 85-86	82RH2010 X 114 LINKS	0925-0854
TRX350 FOURTRAX 4X4 86-87	82RH2015 X 114 LINKS	0925-0854
TRX350D FOURTRAX FOREMAN 4X4 87-89	82RH2015 X 114 LINKS	0925-0854
TRX450 ES/S FOREMAN 98-04	92RH2015 X 56 LINKS	0925-1029
TRX500FE/FM/TM FOREMAN 05-11	92RH2010 X 56 LINKS	0925-1026
KAWASAKI		
KL110A1/A2/A3 84-86	25H X 88 LINKS	0925-0814
KVF360 PRAIRIE 360 (ALL) 03-12	82RH2010 X 118 LINKS	0925-0803
KL400B1 ~B7 BAYOU 4X4 93-99	82RH2010 X 118 LINKS	0925-0803
KVF400 PRAIRIE (ALL) 97-02	82RH2010 X 118 LINKS	0925-0803
SUZUKI		
ALT50 83-84	25H X 98 LINKS	0925-0816
ALT/LT125D/E/F/G/H 83-87	25H X 98 LINKS	0925-0816
LT125 QUADRUNNER 83-87	25H X 98 LINKS	0925-0816
LT160 QUADRUNNER 03-04	25H X 98 LINKS	0925-0816
LT160EK/EL/EM/EN QUADRUNNER 89-92	25H X 98 LINKS	0925-0816
LT-F160M ~K1 QUADRUNNER 91-01	25H X 98 LINKS	0925-0816
LT-F160T QUADRUNNER 91-96	25H X 98 LINKS	0925-0816
ALT185/LT185E/F/G/H 84-87	25H X 98 LINKS	0925-0816
LT250SK/SL QUADRUNNER 89-90	25H X 104 LINKS	0925-0820
LT-4WD QUADRUNNER 87-98	25H X 104 LINKS	0925-0820
LT-4WDX QUADRUNNER 97	25H X 104 LINKS	0925-0820
LT-F250D(FX/FY/FK1/FK2/FK3 OZARK) 99-09	25H X 104 LINKS	0925-0820
LT-F250J/K/L/M/N/P/R/S/T/V 88-09	25H X 104 LINKS	0925-0820
LT-F250T QUADRUNNER 88-96	25H X 104 LINKS	0925-0820
LT-F250W 94-98	25H X 104 LINKS	0925-0820
LT-F300FX ~FK3 KING QUAD 99-03	82RH2010 X 108 LINKS	0925-0811
LT-F4WD KING QUAD 91-98	82RH2010 X 108 LINKS	0925-0811
LT300EH/EJ/EK QUADRUNNER 87-89	82RH2015 X 118 LINKS	0925-0809
LT-A400F EIGER 2 & 4WD 02-03	82RH2010 X 108 LINKS	0925-0811
LT-F400F 2 & 4WD 02-03	82RH2010 X 108 LINKS	0925-0811
LT-F4WDV/WDV QUADRUNNER 97-98	25H X 104 LINKS	0925-0820
YAMAHA		
YFM200DXS ~DXW MOTO 4 86-89	25H X 104 LINKS	0925-0820
YFM200N MOTO 4 85	25H X 104 LINKS	0925-0820
YTM200 TRI-MOTO 83-85	25H X 104 LINKS	0925-0820
YFM225S/T/U MOTO 4 86-88	25H X 104 LINKS	0925-0820
YTM225DRN/DRS TRI-MOTO 85-86	25H X 104 LINKS	0925-0820
YTM225DXK/DXL/DXN TRI-MOTO 83-85	25H X 104 LINKS	0925-0820
YFU1TW (230CC) PRO HAULER 89	25H X 104 LINKS	0925-0820
YFM250M/MC/XN/XHM/ XM/XMC/XHP/XP/XR/XS		
BEAR TRACKER 00-04	25H X 104 LINKS	0925-0820
YFM250BW/XBYB/BYGR/BYR BIG BEAR 250 07-09	25H X 104 LINKS	0925-0820
YFM250BT/BV ~BRUIN 250 05-06	25H X 104 LINKS	0925-0820
YFB250 TIMBERWOLF 92-00	25H X 104 LINKS	0925-0820
YFM250W/A/B MOTO-4 89-91	25H X 104 LINKS	0925-0820
YFM250XL/XLC 99	25H X 104 LINKS	0925-0820
YFM5F GRIZZLY 550 09-14	82RH2010 X 126 LINKS	0925-0806
YFM600FW GRIZZLY 98-00	82RH2015 X 126 LINKS	0925-0805
YFM600HM/HC GRIZZLY 00	82RH2015 X 126 LINKS	0925-0805
YFM7F 700 GRIZZLY 07-15	82RH2010 X 126 LINKS	0925-0806
YXR7F 700 RHINO 08-09	82RH2010 X 126 LINKS	0925-0806
YXR7F 700 RHINO 11-15	82RH2010 X 126 LINKS	0925-0806
YXC700 VIKING VI 700 15-17	82RH2010 X 126 LINKS	0925-0806
YXM700 VIKING 700 14-17	82RH2010 X 126 LINKS	0925-0806

GASKETS

Each set includes high-performance head, base, intake and exhaust gaskets. Our performance sets are designed for a complete top-end rebuild. Made of high-tech materials providing unmatched reliability and performance. Clutch cover gaskets also available separately. Made in the USA.

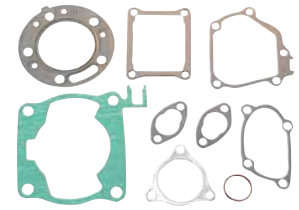

FITS MODEL	TOP END GASKET SET PART #	COMPLETE GASKET SET PART #	COMPLETE SET W/ OIL SEALS PART #	OIL SEAL SET PART #
GASKETS				
ARCTIC CAT				
990 03-05	0934-0084	-	-	-
250 2X4 99-05	M810827	-	-	-
250 4X4 01-05	M810827	-	-	-
300 2X4 98-04	M810826	M808826	-	-
300 4X4 98-05	M810826	M808826	-	-
400 2X4 98-01	M810800	-	-	-
400 4X4 98-00	M810800	-	-	-
400 4X4 W/ AT 03-04	M810846	0934-0443	0934-0444	0935-0822
400 4X4 W/ MT 01-02	M810800	-	-	-
400 4X4 W/ MT 03-04	M810846	-	0934-4586	-
400 FIS 2X4 W/ AT 03-04	M810846	0934-0443	0934-0444	0935-0822
400 FIS 2X4 W/ MT 03-04	M810846	-	0934-4586	-
400 FIS 4X4 W/ AT 03-05	M810846	0934-0443	0934-0444	0935-0822
400 FIS 4X4 W/ MT 03-06	M810846	-	0934-4586	-
454 2X4 97-98	M810800	-	-	-
454 4X4 96-98	M810800	-	-	-
500 4X4 W/ AT 00-02	M810828	-	0934-0119	-
500 4X4 W/ MT 00-01	M810828	M808828	M811828	-
500 FIS 4X4 W/ AT 02-09	M810828	-	0934-0119	-
500 FIS 4X4 W/ MT 02-09	M810828	M808828	M811828	-
650 4X4 H1 05-11	0934-2076	0934-2064	0934-2084	-
650 4X4 H1 MUD PRO 10-11	0934-2076	0934-2064	0934-2084	-
650 4X4 W/ AT V2 04-06	0934-0693	0934-0681	0934-0701	0935-0022
CAN-AM				
OUTLANDER 500 EFI 15	0934-3016	0934-4823	0934-3018	0935-0545
OUTLANDER 500 LTD 4X4 10	0934-3016	0934-4823	0934-3018	0935-0545
OUTLANDER 500 STD 4X4 07-14	0934-3016	0934-4823	0934-3018	0935-0545
OUTLANDER 500 XT 4X4 07-14	0934-3016	0934-4823	0934-3018	0935-0545
OUTLANDER L 500 EFI 15	0934-3016	0934-4823	0934-3018	0935-0545
OUTLANDER MAX 500 STD 4X4 07-15	0934-3016	0934-4823	0934-3018	0935-0545
OUTLANDER MAX 500 XT 4X4 07-14	0934-3016	0934-4823	0934-3018	0935-0545
RENEGADE 500 08-15	0934-3016	0934-4823	0934-3018	0935-0545
TRAXTER 500 99-05	-	0934-4823	-	-
OUTLANDER DPS 570 EFI 16-17	-	-	-	0935-0545
OUTLANDER L 570 EFI 16	-	-	-	0935-0545
OUTLANDER MAX 570 EFI 16	-	-	-	0935-0545
OUTLANDER MAX DPS 570 EFI 16	-	-	-	0935-0545
OUTLANDER X MR 570 EFI 16-17	-	-	-	0935-0545
RENEGADE 570 EFI 16-17	-	-	-	0935-0545
OUTLANDER 650 6X6 15	0934-3016	M808853	0934-3018	0935-0545
OUTLANDER 650 STD 4X4 06-15	0934-3016	0934-4823	0934-3018	0935-0545
OUTLANDER 650 XMR 13-15	0934-3016	0934-4823	0934-3018	0935-0545
OUTLANDER 650 XT 4X4 06-14	0934-3016	0934-4823	0934-3018	0935-0545
OUTLANDER DPS 650 EFI 17	-	-	-	0935-0545
OUTLANDER MAX 650 EFI 15	0934-3016	0934-4823	0934-3018	0935-0545
OUTLANDER MAX 650 ALL 4X4 06-14	0934-3016	0934-4823	0934-3018	0935-0545
COMMANDER 800 11-15	0934-3017	0934-4825	0934-3020	-
COMMANDER 800 ALL 16-17	0934-3017	0934-4825	-	-
COMMANDER MAX 800 DPS 17	0934-3017	0934-4825	-	-
COMMANDER MAX 800 DPS/LTD 16	0934-3017	0934-4825	-	-
DEFENDER 800 16-17	0934-3017	-	-	-
OUTLANDER 800 STD 4X4 06-08	0934-3017	0934-4824	0934-3019	0935-0545
OUTLANDER 800 XMR 11	0934-3017	0934-4824	0934-3019	0935-0545
OUTLANDER 800 XMR 12	0934-3017	0934-4824	0934-3020	-
OUTLANDER 800 XT 4X4 06-08	0934-3017	0934-4824	0934-3019	0935-0545
OUTLANDER 800 XMC 11	0934-3017	0934-4824	0934-3019	0935-0545
OUTLANDER 800R EFI 15	0934-3017	0934-4825	0934-3020	-
OUTLANDER 800R EFI XMR 15	0934-3017	0934-4825	0934-3020	-
OUTLANDER 800R STD 4X4 09-11	0934-3017	0934-4824	0934-3019	0935-0545
OUTLANDER 800R STD 4X4 12-14	0934-3017	0934-4825	0934-3020	0935-0545
OUTLANDER MAX 800 STD 4X4 06-08	0934-3017	0934-4824	0934-3019	0935-0545
OUTLANDER MAX 800 XT 4X4 06-08	0934-3017	0934-4824	0934-3019	0935-0545
OUTLANDER MAX 800R EFI 15	0934-3017	0934-4825	0934-3020	-
OUTLANDER MAX 800R LTD 4X4 09-12	0934-3017	0934-4824	0934-3019	0935-0545
OUTLANDER MAX 800R LTD 4X4 12	0934-3017	0934-4824	0934-3020	-
OUTLANDER MAX 800R STD 4X4 09-12	0934-3017	0934-4824	0934-3019	0935-0545

ENGINE

FITS MODEL	TOP END GASKET SET PART #	COMPLETE GASKET SET PART #	COMPLETE SET W/ OIL SEALS PART #	OIL SEAL SET PART #
GASKETS (CON'T)				
CAN-AM (CON'T)				
OUTLANDER MAX 800R STD 4X4 13-14	0934-3017	0934-4825	0934-3020	0935-0545
OUTLANDER MAX 800R XT 4X4 09-12	0934-3017	0934-4824	0934-3019	0935-0545
OUTLANDER MAX 800R XT 4X4 12-14	0934-3017	0934-4824	0934-3020	-
OUTLANDER MAX 800R XT 4X4 13-14	0934-3017	0934-4825	0934-3020	0935-0545
RENEGADE 800 07-11	0934-3017	0934-4824	0934-3019	0935-0545
RENEGADE 800 12-15	0934-3017	0934-4825	0934-3020	-
RENEGADE 800 X 08-09	0934-3017	0934-4824	0934-3019	0935-0545
RENEGADE 800 XXC 10-11	0934-3017	0934-4824	0934-3019	0935-0545
RENEGADE 800 XXC 12-14	0934-3017	0934-4825	0934-3020	-
OUTLANDER DPS 850 EFI 17	-	-	-	0935-0545
OUTLANDER MAX DPS 850 EFI 17	-	-	-	0935-0545
RENEGADE 850 16-17	-	-	-	0935-0545
RENEGADE 850 XXC 16-17	-	-	-	0935-0545
COMMANDER 1000 11-15	0934-3017	0934-4825	0934-3020	-
COMMANDER MAX 1000 14-15	0934-3017	0934-4825	0934-3020	-
COMMANDER 1000 16	0934-3017	0934-4825	0934-4834	-
COMMANDER MAX 1000 XT/DPS/LTD 14-16	0934-3017	0934-4825	0934-4834	-
COMMANDER 1000 DPS 17	0934-3017	0934-4825	-	-
COMMANDER 1000 LTD 17	0934-3017	0934-4825	-	-
COMMANDER 1000 STD 16-17	0934-3017	0934-4825	-	-
COMMANDER 1000 XT 16-17	0934-3017	0934-4825	-	-
COMMANDER 1000 XTP 16-17	0934-3017	0934-4825	-	-
COMMANDER MAX 1000 STD 16	0934-3017	0934-4825	-	-
COMMANDER MAX 1000 XT/DPS/LTD 17	0934-3017	0934-4825	-	-
MAVERICK 1000 13-15	0934-3017	0934-4825	0934-3020	-
MAVERICK 1000 XDS-DPS 15	0934-3017	0934-4825	0934-4834	-
MAVERICK 1000 XMR 15	0934-3017	0934-4825	0934-4834	-
MAVERICK 1000 XXC 15	0934-3017	0934-4825	0934-4834	-
MAVERICK MAX 1000 14-15	0934-3017	0934-4825	0934-4834	-
OUTLANDER 1000 EFI 15	0934-3017	0934-4825	0934-3020	-
OUTLANDER 1000 EFI 6X6 15	0934-3017	0934-4825	0934-4834	-
OUTLANDER 1000 EFI XMR 15	0934-3017	0934-4825	0934-3020	-
OUTLANDER 1000 STD 4X4 12-14	0934-3017	0934-4825	0934-3020	-
OUTLANDER 1000 XMR 13-14	0934-3017	0934-4825	0934-3020	-
OUTLANDER 1000 XT 4X4 12-14	0934-3017	0934-4825	0934-3020	-
OUTLANDER DPS 1000 EFI 17	0934-3017	0934-4825	-	-
OUTLANDER MAX 1000 EFI 15	0934-3017	0934-4825	0934-3020	-
OUTLANDER MAX 1000 STD 4X4 13-14	0934-3017	0934-4825	0934-3020	-
OUTLANDER MAX 1000 XT 4X4 13-14	0934-3017	0934-4825	0934-3020	-
OUTLANDER X MR DPS 1000 EFI 17	0934-3017	0934-4825	-	-
RENEGADE 1000 12-16	0934-3017	0934-4825	0934-3020	-
RENEGADE 1000 XXC 12-14	0934-3017	0934-4825	0934-3020	-
HONDA				
ATC185 80-83	M810816	-	-	-
ATC200E 82-83	M810816	-	-	-
ATC200ES 84	M810816	-	-	-
ATC200M 84-85	M810816	-	-	-
ATC200S 84-86	M810816	-	-	0935-0391
ATC200X 83-87	M810816	-	-	0935-0391
TRX200 84	M810816	-	-	-
TRX200 90-97	M810817	-	-	0935-0382
TRX200D 90-97	M810817	-	-	0935-0382
ATC250ES 85-87	M810802	M808802	M811802	M822168
ATC250R 85-86	M810814	M808814	M811814	M822147
ATC250R 0.01SS HC HG 85-86	M810815	M808815	M811815	M822147
ATC250SX 85-87	M810802	M808802	M811802	M822168
TRX250 FOURTRAX 85-87	M810802	M808802	M811802	M822168
TRX250 RECON 97-01	M810841	-	0934-0122	-
TRX250TM RECON 02-16	0934-0413	0934-1170	0934-1179	0935-0466
TRX300 FOURTRAX 88-00	-	-	-	M822168
TRX300 FOURTRAX 77MM OB 88-00	-	-	-	M822168
TRX300FW FOURTRAX 4X4 88-00	-	-	-	M822168
TRX300FW FOURTRAX 4X4 77MM OB 88-00	-	-	-	M822168
TRX350FE 00-06	0934-0416	0934-0417	0934-0418	0935-0017
TRX350FM FOURTRAX RANCHER 00-06	0934-0416	0934-0417	0934-0418	0935-0017
TRX350TE 00-06	0934-0416	0934-0417	0934-0418	0935-0017
TRX350TM FOURTRAX RANCHER 00-06	0934-0416	0934-0417	0934-0418	0935-0017
TRX400FA 04-07	0934-1174	-	0934-1177	-
TRX400FGA FOURTRAX RANCHER 4X4 04-07	0934-1174	-	0934-1177	-
TRX400FW FOURTRAX FOREMAN 4X4 95-03	0934-0092	0934-0153	0934-0125	0935-0018
TRX420 FA 09-14	0934-2078	-	-	0935-0396
TRX420 FA 15-16	0934-2078	0934-2069	0934-2089	0935-0394
TRX420 FE/FM 09-16	0934-2078	0934-2069	0934-2089	0935-0394
TRX420 FPA 09-14	0934-2078	-	-	0935-0396

FITS MODEL	TOP END GASKET SET PART #	COMPLETE GASKET SET PART #	COMPLETE SET W/ OIL SEALS PART #	OIL SEAL SET PART #
GASKETS (CON'T)				
HONDA (CON'T)				
TRX420 FPM 11-13	0934-2078	0934-2069	0934-2089	0935-0394
TRX420 FPM 11-13	0934-2078	0934-2069	0934-2089	0935-0394
TRX420 TE/TM 09-15	0934-2078	0934-2069	0934-2089	0935-0394
TRX450ES 98-01	0934-0093	0934-0154	0934-0126	0935-0019
TRX450FE/FM 02-04	0934-0093	0934-0154	0934-0126	0935-0019
TRX450S 98-01	0934-0093	0934-0154	0934-0126	0935-0019
TRX500FA 01-14	M810843	0934-0424	0934-0425	-
TRX500FE 05-11	0934-0697	-	0934-0708	-
TRX500FGA 04-08	M810843	0934-0424	0934-0425	-
TRX500FM 05-11	0934-0697	0934-0689	0934-0709	0935-0384
TRX500FPA 09-11	M810843	0934-0424	0934-0425	-
TRX500FPE 07-11	0934-0697	-	0934-0708	-
TRX500FPM 08-11	0934-0697	0934-0689	0934-0709	0935-0384
TRX500TM 05-06	0934-0697	0934-0689	0934-0709	0935-0384
KAWASAKI				
KLF220 BAYOU 88-02	M810803	M808803	M811803	M822138
KLF250 BAYOU 03-11	-	-	-	M822138
KEF300 LAKOTA 95-03	M810805	-	-	0935-0379
KLF300A BAYOU 86-87	M810805	-	-	0935-0380
KLF300B BAYOU 88-04	M810805	-	-	0935-0380
KLF300C BAYOU 4X4 89-05	M810805	-	-	0935-0380
KVF300A PRAIRIE 4X4 99-02	M810805	-	-	-
KVF300B PRAIRIE 2X4 99-02	M810805	-	-	-
KVF360A/C PRAIRIE 4X4 03-13	M810845	-	0934-0123	-
KVF360B PRAIRIE 03-10	M810845	-	-	-
KLF400 BAYOU 93-99	M810831	-	M811831	-
KVF400A PRAIRIE 4X4 97-98	M810831	-	-	-
KVF400B PRAIRIE 98	M810831	-	-	-
KVF400C PRAIRIE 4X4 99-02	M810831	-	-	-
KVF400D PRAIRIE 99-02	M810831	-	-	-
KVF650 BRUTE FORCE 05-13	0934-0693	0934-0681	0934-0701	0935-0022
KVF650 I BRUTE FORCE 06-13	0934-4585	-	0934-4590	0935-0022
KVF650 PRAIRIE 02-03	0934-0693	0934-0681	0934-0701	0935-0022
KFX 700 V-FORCE 04-09	0934-0694	-	0934-0702	0935-0022
KVF700 PRAIRIE 04-06	0934-0694	-	0934-0702	0935-0022
KVF750 BRUTE FORCE 05-12	0934-0426	0934-0427	0934-0428	0935-0022
KVF750 BRUTE FORCE 13-17	0934-0426	0934-0427	0934-4835	0935-0851
TERYX 750 4X4 08-13	0934-0426	0934-0427	0934-0428	0935-0022
POLARIS				
SPORTSMAN 90 01-04	0934-0084	0934-0685	0934-0705	0935-0383
SPORTSMAN 90 05-06	0934-0084	-	-	-
SPORTSMAN 90 07-13	0934-1670	-	-	-
BIG BOSS 250 4X6 89-92	M810806	M808806	M811806	M822140
BIG BOSS 250 6X6 91-93	M810806	M808806	M811806	M822140
TRAIL BLAZER 250 90-06	M810806	M808806	M811806	M822140
TRAIL BOSS 250 4X4 87-95	M810806	M808806	M811806	M822140
TRAIL BOSS 250 85-99	M810806	M808806	M811806	M822140
XPLORER 250 4X4 00-02	M810806	M808806	M811806	M822140
300 2X4/4X4 94-95	M810807	-	M811807	M822140
BIG BOSS 300 6X6 94	-	-	-	M822142
XPLORER 300 4X4 96-99	M810807	-	M811807	M822140
XXPRESS 300 96-99	M810807	-	M811807	M822140
MAGNUM 325 2X4/4X4 00-02	M810836	-	M811836	M822143
MAGNUM 325 4X4 HDS 01-02	M810836	-	M811836	M822143
SPORTSMAN ACE 325 14-16	0934-4831	-	-	-
SPORTSMAN EXT EFI 325 15	0934-4831	-	-	-
TRAIL BOSS 325 00-02	M810836	-	M811836	M822143
XPEdition 325 00-02	M810836	-	-	-
TRAIL BLAZER 330 08-13	M810836	-	M811836	M822143
TRAIL BOSS 330 03-13	M810836	-	M811836	M822143
ATP 330 4X4 04-05	M810836	-	-	-
MAGNUM 330 2X4/4X4 03-05	M810836	-	M811836	M822143
SPORTSMAN 335 99-00	M810837	-	-	M822143
SPORTSMAN 350 4X4 93	-	-	-	M822142
350L 2X4/4X4 93	-	-	-	M822142
BIG BOSS 350L 6X6 93	-	-	-	M822142
TRAIL BOSS 350L 2X4/4X4 90-92	-	-	-	M822142
400L 2X4/4X4 94-95	M810808	M808808	M811808	M822142
BIG BOSS 400L 6X6 94-97	M810808	M808808	M811808	M822142
HAWKEYE 400 HO 2X4 11-14	M810821	M808821	M811821	M822143
MAGNUM 400L 6X6 96-97	M810808	M808808	M811808	M822142
SPORTSMAN 400 4X4 01-05	M810821	M808821	M811821	M822143
SPORTSMAN 400 4X4 94-97	M810808	M808808	M811808	M822142
SPORTSMAN 400 HO 4X4 08-14	M810821	M808821	M811821	M822143

FITS MODEL	TOP END GASKET SET PART #	COMPLETE GASKET SET PART #	COMPLETE SET W/ OIL SEALS PART #	OIL SEAL SET PART #
GASKETS (CON'T)				
POLARIS (CON'T)				
TRAIL BLAZER 400 03	M810808	M808808	M811808	M822142
XPLORER 400L 4X4 95-02	M810808	M808808	M811808	M822142
XPRESS 400L 2X4 96-97	M810808	M808808	M811808	M822142
MAGNUM 425 2X4/4X4 95-98	M810821	M808821	M811821	M822143
XPEDITION 425 00-02	M810821	-	-	-
SPORTSMAN 450 06-07	M810821	M808821	M811821	M822143
ATP 500 4X4 04-05	M810830	M808830	M811830	M822143
BIG BOSS 500 6X6 98-03	M810830	M808830	M811830	M822143
MAGNUM 500 2X4 HDS 02	M810830	M808830	M811830	M822143
MAGNUM 500 4X4 99-02	M810830	M808830	M811830	M822143
MAGNUM 500 4X4 HDS 01-03	M810830	M808830	M811830	M822143
SPORTSMAN 500 4X4 96-00	M810830	M808830	M811830	M822143
SPORTSMAN 500 4X4 HO 01-13	0934-0698	0934-4579	0934-4588	M822143
SPORTSMAN 500 6X6 00-08	M810830	M808830	M811830	M822143
SPORTSMAN 500 EFI 09	0934-0698	0934-4579	0934-4588	M822143
SPORTSMAN 500 X2 06-09	0934-0698	0934-4579	0934-4588	M822143
SPORTSMAN TOURING 500 10-13	0934-0698	0934-4579	0934-4588	M822143
SPORTSMAN TOURING 500 EFI 08-09	0934-0698	0934-4579	0934-4588	M822143
XPLORER 500 97	M810830	M808830	M811830	M822143
SPORTSMAN 550 EPS 10-14	0934-4829	-	-	-
SPORTSMAN 550 X2 10-14	0934-4829	-	-	-
SPORTSMAN 550 XP 13-14	0934-4829	-	-	-
SPORTSMAN TOURING EPS 550 10-14	0934-4829	-	-	-
SPORTSMAN XP 550 09-10	0934-4829	-	-	-
SPORTSMAN 570 EFI ALL 14-15	0934-4828	-	-	-
SPORTSMAN ACE 570 2015	0934-4828	-	-	-
SPORTSMAN 700 4X4 05-07	0934-2080	0934-2071	0934-2091	0935-0395
SPORTSMAN X2 700 EFI 08	0934-2080	0934-2071	0934-2091	0935-0395
SPORTSMAN 800 EFI 05-10	0934-2080	0934-2071	0934-2091	0935-0395
SPORTSMAN TOURING 800 EFI 08-09	0934-2080	0934-2071	0934-2091	0935-0395
SPORTSMAN X2 800 EFI 07-09	0934-2080	0934-2071	0934-2091	0935-0395
SCRAMBLER HO/ EPS 850 13-14	0934-4826	-	-	-
SPORTSMAN 850 SP 15	0934-4826	-	-	-
SPORTSMAN 850 WV 14	0934-4826	-	-	-
SPORTSMAN TOURING 850 SP 15	0934-4826	-	-	-
SPORTSMAN TOURING EPS 850 10-14	0934-4826	-	-	-
SPORTSMAN X2 850 11	0934-4826	-	-	-
SPORTSMAN XP 850 09-13	0934-4826	-	-	-
SPORTSMAN XP 850 EPS 10-14	0934-4826	-	-	-
SPORTSMAN 900 ACE EFI EPS 16	0934-4832	-	-	-
SPORTSMAN 1000 XP 15-16	0934-4827	-	-	-
SPORTSMAN TOURING 1000 15-16	0934-4827	-	-	-
RANGER ETX 325 15-16	0934-4831	-	-	-
RANGER 4X4 400 10-14	M810821	M808821	M811821	M822143
RANGER 2X4 500 05-09	M810830	M808830	M811830	M822143
RANGER 4X4 500 99-13	M810830	M808830	M811830	M822143
RANGER 4X4 500 CREW 11-13	M810830	M808830	M811830	M822143
RANGER 4X4 500 EFI 06	0934-0698	0934-4579	0934-4588	M822143
RANGER 6X6 500 98-05	M810830	M808830	M811830	M822143
RANGER 4X4 570 14-15	0934-4828	-	-	-
RANGER 4X4 570 CREW 14-15	0934-4828	-	-	-
RANGER 4X4 570 FULL SIZE/ CREW 15-16	0934-4828	-	-	-
RANGER 4X4 700 05-09	0934-2080	0934-2071	0934-2091	0935-0395
RANGER 4X4 700 CREW 08-09	0934-2080	0934-2071	0934-2091	0935-0395
RANGER 6X6 700 EFI 06-09	0934-2080	0934-2071	0934-2091	0935-0395
RANGER 4X4 800 EFI 10	0934-2080	0934-2071	0934-2091	0935-0395
RANGER 4X4 800 EFI 11-14	0934-4830	-	-	-
RANGER 4X4 800 EFI CREW 10	0934-2080	0934-2071	0934-2091	0935-0395
RANGER 4X4 800 EFI CREW 11-14	0934-4830	-	-	-
RANGER 4X4 800 EFI MIDSIZE 13-14	0934-4830	-	-	-
RANGER 6X6 800 10	0934-2080	0934-2071	0934-2091	0935-0395
RANGER 6X6 800 11-16	0934-4830	-	-	-
RANGER XP 800 12	0934-4830	-	-	-
RANGER 900 CREW 14-16	0934-4832	-	-	-
RANGER 900 XP 13-16	0934-4832	-	-	-
RZR 570 EFI 12-15	0934-4828	-	-	-
RZR 4 800 11-14	0934-4830	-	-	-
RZR S 800 11-14	0934-4830	-	-	-
RZR 4 800 10	0934-2080	0934-2071	0934-2091	0935-0395
RZR S 800 09	0934-2080	0934-2071	0934-2091	0935-0395
RZR 800 08-10	0934-2080	0934-2071	0934-2091	0935-0395
RZR 800 11	0934-4830	-	-	-
RZR 900 50 55 INCH 15-16	0934-4832	-	-	-
RZR 900 60 INCH 15	0934-4832	-	-	-

FITS MODEL	TOP END GASKET SET PART #	COMPLETE GASKET SET PART #	COMPLETE SET W/ OIL SEALS PART #	OIL SEAL SET PART #
GASKETS (CON'T)				
POLARIS (CON'T)				
RZR XP 900 11-14	0934-4833	-	-	-
RZR 4 900 15-16	0934-4832	-	-	-
RZR 4 XP 900 12-14	0934-4833	-	-	-
RZR XP 1000 14-16	0934-4832	-	-	-
RZR XP 1000 TURBO 16	0934-4832	-	-	-
RZR XP 4 1000 14-16	0934-4832	-	-	-
RZR 1000 60 INCH 16	0934-4832	-	-	-
SUZUKI				
LT-A50 02-05	0934-0088	0934-0152	0934-2082	-
LT-80 87-06	0934-0087	0934-0151	0934-2081	0935-0378
LT-F160 91-01	0934-0086	-	-	-
LT-230E 87-93	M810809	-	M811809	-
LT-4WD 250 QUAD RUNNER 87-98	M810810	M808810	M811810	-
LT-F250 2WD 88-01	M810810	M808810	M811810	-
LT-F250 QZARK 02-14	0934-0695	0934-0684	-	-
LT-F250F 4WD QUAD RUNNER 99-02	M810810	M808810	M811810	-
LT-F300F KING QUAD 99-02	M810832	M808832	M811832	-
LT-F4WDX KING QUAD 300 91-98	M810832	M808832	M811832	-
LT-A400 2WD KING QUAD 08-09	M810846	0934-0443	0934-0444	0935-0822
LT-A400 EIGER 2WD 02-07	M810846	0934-0443	0934-0444	0935-0822
LT-A400F 4WD KING QUAD 08-14	M810846	-	-	0935-0822
LT-A400F EIGER 4WD 02-07	M810846	0934-0443	0934-0444	0935-0822
LT-F400 2WD KING QUAD 08-09	M810846	-	0934-4586	-
LT-F400 EIGER 2WD 02-07	M810846	-	0934-4586	-
LT-F400F 4WD KING QUAD 08-12	M810846	-	0934-4586	-
LT-F400F EIGER 4WD 02-07	M810846	-	0934-4586	-
LT-A500F QUAD MASTER AUTO 00-01	M810828	-	0934-0119	-
LT-A500F VINSON 02-07	M810828	-	0934-0119	-
LT-F500F 98-02	M810828	M808828	M811828	-
LT-F500F VINSON 03-07	M810828	M808828	M811828	-
LTV-700F TWIN PEAKS 04-06	0934-0694	-	0934-0702	0935-0022
YAMAHA				
YFM80 BADGER 85-01	0934-1431	0934-1428	-	-
YFM80 GRIZZLY 05-08	0934-1431	0934-1428	-	-
YFA1 91-04	0934-2075	0934-2063	-	-
YFM125 GRIZZLY 04-13	0934-2075	0934-2063	-	-
YFB250 TIMBERWOLF 92-98	M810824	0934-4578	0934-4587	-
YFB250FW TIMBERWOLF 94-00	M810824	-	-	-
YFM250 BEARTRACKER 99-04	M810824	0934-4578	0934-4587	-
YFM250 BIG BEAR 07-09	M810824	0934-4578	0934-4587	-
YFM250 MOTO-4 89-91	M810824	0934-4578	0934-4587	-
YFM250B BRUIN 05-06	M810824	0934-4578	0934-4587	-
YFM350 GRIZZLY IRS 07	M810813	0934-0683	-	-
YFM350 GRIZZLY IRS 08-11	M810813	0934-0683	0934-0703	-
YFM350 WARRIOR 87-04	M810813	M808813	M811813	M822155
YFM350BA BRUIN 2X4/4X4 04-06	M810813	0934-0683	0934-0703	-
YFM350FGW GRIZZLY 4WD 07-14	M810813	0934-0683	0934-0703	-
YFM350FW BIG BEAR 97-99	M810813	0934-0155	0934-0127	0935-0821
YFM350GW GRIZZLY 2WD 07-11	M810813	0934-0683	0934-0703	-
YFM35FX WOLVERINE 95-05	M810813	0934-0155	0934-0127	0935-0821
YFM35X WOLVERINE 06-09	M810813	0934-0683	0934-0703	-
YFM400 BIG BEAR 2WD 00-04	M810813	0934-0155	0934-0127	0935-0821
YFM400 BIG BEAR 4WD 00-06	M810813	0934-0155	0934-0127	0935-0821
YFM400 BIG BEAR IRS 07-12	M810813	0934-0155	0934-0127	0935-0821
YFM400 GRIZZLY IRS 07-08	0934-0691	0934-0679	0934-0699	0935-0381
YFM400 KODIAK 2WD 00-04	0934-0691	0934-0679	0934-0699	0935-0381
YFM400 KODIAK 4WD 99	M810813	0934-0155	0934-0127	0935-0821
YFM400 KODIAK 4WD 00-06	0934-0691	0934-0679	0934-0699	0935-0381
450 RHINO 06-09	0934-0691	0934-0679	0934-0699	0935-0381
YFM450 GRIZZLY EPS 11-14	0934-0691	0934-0679	0934-0699	0935-0381
YFM450 GRIZZLY IRS 07-14	0934-0691	0934-0679	0934-0699	0935-0381
YFM450 KODIAK 03-06	0934-0691	0934-0679	0934-0699	0935-0381
YFM45FX WOLVERINE 450 4X4 06-10	0934-0691	0934-0679	0934-0699	0935-0381
YFM550 GRIZZLY 09-14	0934-4584	-	0934-4589	-
YFM550 GRIZZLY EPS 09-14	0934-4584	-	0934-4589	-
YFM600 GRIZZLY 98-01	M810833	M808833	M811833	0935-0819
660 RHINO04-07	0934-0432	0934-0433	0934-0434	0935-0025
660 RHINO102MM 0B 04-07	-	-	-	0935-0024
YFM660 GRIZZLY 02-08	0934-0432	0934-0433	0934-0434	0935-0024
YFM660 GRIZZLY 102MM 0B 02-08	-	-	-	0935-0024
700 RHINO1 08-13	0934-1704	0934-2068	0934-2088	-
YFM700 GRIZZLY 07-15	0934-1704	0934-2068	0934-2088	-
YFM700 GRIZZLY EPS 08-15	0934-1704	0934-2068	0934-2088	-
VIKING 700 / 700 V1 16-17	0934-1704	0934-2068	0934-2088	-

PLOWES
WINCHES
UTV
RACKS
IMPLEMENT & TOWING
LUGGAGE
BODY
CONTROLS
ELECTRICAL
WHEELS & TIRES
SUSPENSION & DRIVE
BRAKING
ENGINE
RIDER
GARAGE
PROMO

ENGINE

FITS MODEL	PART #
CLUTCH COVER GASKETS	
ARCTIC CAT	
TRX200 90-97	0934-1414
TRX200D 90-97	0934-1414
ATC250R 85-86	0934-1422
ATC250SX 85-87	0934-1420
TRX250 FOURTRAX 85-87	0934-1420
TRX250 RECON 97-01	0934-1409
TRX250R 86-89	0934-1422
TRX250TE RECON 02-14	0934-1409
TRX300 FOURTRAX 88-00	0934-1420
TRX300FW FOURTRAX 4X4 88-00	0934-1420
TRX300FW FOURTRAX 4X4 77MM 08 88-00	0934-1420
TRX400FW FOURTRAX FOREMAN 4X4 95-03	0934-1406
TRX450ES 98-01	0934-1406
TRX450FE/FM 02-04	0934-1406
TRX450S 98-01	0934-1406
TRX500FE 05-11	0934-4591
TRX500FGA 05-08	0934-4591
TRX500FM 05-11	0934-4591
TRX500FPE 07-11	0934-4591
TRX500FPM 08-11	0934-4591
TRX500TM 05-06	0934-4591
KAWASAKI	
KLF220 BAYOU 88-02	0934-1424
KLF250 BAYOU 03-11	0934-1424
SUZUKI	
LT-4WD 250 QUAD RUNNER 87-98	0934-1425
LT-F250 2WD 88-01	0934-1425
LT-F250F 4WD QUAD RUNNER 99-02	0934-1425
LT-F250 OZARK 02-14	0934-1412
LT-F300F KING QUAD 99-02	0934-1425
LT-FAWDX KING QUAD 300 91-98	0934-1425
YAMAHA	
YFM600 GRIZZLY 98-01	0934-1408



EXHAUST GASKET KITS

2-stroke kits include O-rings, springs, washer and gasket (where applicable). 4-stroke kits contains header gasket.

FITS MODEL	PART #
EXHAUST GASKETS	
ARCTIC CAT	
50 Y-6 04-05	0934-5277
90 2-STROKE 02-04	0934-5277
90 4-STROKE 05	0934-5277
350 CR 12	0934-5281
350 UTILITY 4X4 11	0934-5281
366 FIS W/ AT 09-11	0934-5281
375 2X4 W/ AT 02	0934-5281
375 4X4 W/ AT 02	0934-5281
400 2X4 98-01	0934-5281
400 4X4 98-00	0934-5281
400 4X4 14-15	0934-5281
400 4X4 W/ AT 03-04	0934-5281
400 4X4 W/ MT 01-02	0934-5281
400 4X4 W/ MT 03-04	0934-5281
400 FIS 2X4 W/ AT 03-04	0934-5281
400 FIS 2X4 W/ MT 03-04	0934-5281
400 FIS 4X4 TRV 09-14	0934-5281
400 FIS 4X4 W/ AT 03-05	0934-5281
400 FIS 4X4 W/ AT 06-08	0934-5281
400 FIS 4X4 W/ AT 13-14	0934-5281
400 FIS 4X4 W/ MT 02	0934-5281
400 FIS 4X4 W/ MT 03-08	0934-5281
400 TBX 4X4 04-06	0934-5281

FITS MODEL	PART #
EXHAUST GASKETS (CON'T)	
ARCTIC CAT (CON'T)	
400 VP 4X4 W/ AT 05-06	0934-5281
400 VP 4X4 W/ MT 05-06	0934-5281
ALTERRA 400 16-17	0934-5281
454 2X4 97-98	0934-5281
454 4X4 96-98	0934-5281
500 4X4 98-99	0934-5281
500 4X4 W/ AT 00-02	0934-5281
500 4X4 W/ MT 00-01	0934-5281
500 FIS 4X4 W/ AT 02-06	0934-5281
500 FIS 4X4 W/ AT 07-09	0934-5281
500 FIS 4X4 W/ MT 02-09	0934-5281
500 FIS TBX 4X4 02-06	0934-5281
500 FIS TRV 4X4 03-08	0934-5281
550 EFI 4X4 12-13	0934-5292
550 GT EFI 4X4 12	0934-5292
550 HI FIS 4X4 09-11	0934-5292
550 TRV 4X4 W/ AT 09-13	0934-5292
550 TRV XT/LTD 14-15	0934-5292
550 XR EFI/XT/LTD 15	0934-5292
550 XT EFI 4X4 13-14	0934-5292
550 XT LTD EFI 12-14	0934-5292
ALTERRA 550 16	0934-5292
650 4X4 HI 05-11	0934-5292
650 4X4 HI MUD PRO 10-11	0934-5292
650 4X4 W/ AT V2 04-06	0934-5493
650 HI TBX 07	0934-5281
650 HI TBX 09	0934-5292
650I 4X4 12	0934-5292
700 EFI/LTD 11-14	0934-5292
700 EFI HI 08-11	0934-5292
700 EFI HI MUDPRO 09-11	0934-5292
700 GT EFI 12	0934-5292
700 LTD EFI 13	0934-5292
700 TBX 10-15	0934-5292
700 TBX 17	0934-5292
700 TRV 09-15	0934-5292
700 XR 15	0934-5292
700 XT 13-14	0934-5292
700I EFI MUDPRO/LTD 12-15	0934-5292
700I HI TRV GT EFI 11	0934-5292
ALTERRA 700 16-17	0934-5292
ALTERRA 700 XT EPS 17	0934-5292
ALTERRA TRV 700 XT EPS 17	0934-5292
HDX 700 CREW XT 17	0934-5292
HDX 700 XT 17	0934-5292
PROWLER 700 XT 17	0934-5292
CAN-AM	
QUEST 50 03	0934-5277
OUTLANDER 330 04-05	0934-6031
OUTLANDER 400 03-04	0934-6031
OUTLANDER 400 STD 2X4 05	0934-6031
OUTLANDER 400 STD 4X4 05-15	0934-6031
OUTLANDER 400 XT 4X4 04-14	0934-6031
OUTLANDER MAX 400 EFI/STD/XT 15	0934-6031
OUTLANDER MAX 400 STD 4X4 05-14	0934-6031
OUTLANDER MAX 400 XT 4X4 06-14	0934-6031
OUTLANDER DPS 450 EFI 17-19	0934-6031
OUTLANDER L 450 EFI 15-16	0934-6027
OUTLANDER L MAX 450 EFI 15-16	0934-6027
OUTLANDER MAX DPS 450 EFI 17	0934-6027
OUTLANDER 500 LTD 4X4 10	0934-6027
OUTLANDER 500 STD 4X4 07-15	0934-6027
OUTLANDER 500 XT 4X4 07-14	0934-6027
OUTLANDER L 500 EFI 15	0934-6027
OUTLANDER L MAX 500 EFI 15	0934-6027
OUTLANDER MAX 500 EFI 15	0934-6027
OUTLANDER MAX 500 STD 4X4 07-14	0934-6027
OUTLANDER MAX 500 XT 4X4 07-14	0934-6027
RENEGADE 500 08-15	0934-6027
RENEGADE 500 XT 12	0934-6027
OUTLANDER DPS 570 EFI 16-19	0934-6027
OUTLANDER L 570 EFI 16	0934-6027
OUTLANDER LE 570 EFI 16	0934-6027
OUTLANDER MAX 570 EFI 16	0934-6027
OUTLANDER MAX DPS 570 EFI 16	0934-6027
OUTLANDER XMR 570 EFI 16-17	0934-6027

FITS MODEL	PART #
EXHAUST GASKETS (CON'T)	
CAN-AM (CON'T)	
RENEGADE 570 EFI 16-19	0934-6027
OUTLANDER 650 6X6 15	0934-6027
OUTLANDER 650 STD 4X4 06-15	0934-6027
OUTLANDER 650 XMR 13-15	0934-6027
OUTLANDER 650 XT 4X4 06-14	0934-6027
OUTLANDER DPS 650 EFI 17	0934-6027
OUTLANDER MAX 650 STD 4X4 06-15	0934-6027
OUTLANDER MAX 650 XT 4X4 06-14	0934-6027
COMMANDER 800 DPS 13-17	0934-6027
COMMANDER 800 LTD 16	0934-6027
COMMANDER 800 STD 11-17	0934-6027
COMMANDER 800 XT 11-17	0934-6027
COMMANDER 800 XTP 16	0934-6027
COMMANDER MAX 800 DPS 17	0934-6027
COMMANDER MAX 800 DPS/LTD 16	0934-6027
DEFENDER 800 16-17	0934-6027
DEFENDER 800 XT/DPS 16-17	0934-6027
OUTLANDER 800 STD 4X4 06-08	0934-6027
OUTLANDER 800 XMR 11-12	0934-6027
OUTLANDER 800 XT 4X4 06-08	0934-6027
OUTLANDER 800 XXC 11	0934-6027
OUTLANDER 800R EFI XMR 15	0934-6027
OUTLANDER 800R STD 4X4 09-11	0934-6027
OUTLANDER 800R STD 4X4 12-15	0934-6027
OUTLANDER 800R XT 4X4 09-11	0934-6027
OUTLANDER 800R XT 4X4 12-14	0934-6027
OUTLANDER MAX 800 LTD 4X4 07-08	0934-6027
OUTLANDER MAX 800 STD 4X4 06-08	0934-6027
OUTLANDER MAX 800 XT 4X4 06-08	0934-6027
OUTLANDER MAX 800R EFI 15	0934-6027
OUTLANDER MAX 800R LTD 4X4 09-12	0934-6027
OUTLANDER MAX 800R STD 4X4 09-12	0934-6027
OUTLANDER MAX 800R STD 4X4 13-14	0934-6027
OUTLANDER MAX 800R XT 4X4 09-12	0934-6027
OUTLANDER MAX 800R XT 4X4 13-14	0934-6027
RENEGADE 800 07-11	0934-6027
RENEGADE 800 12-15	0934-6027
RENEGADE 800 X 08-09	0934-6027
RENEGADE 800 XXC 10-11	0934-6027
RENEGADE 800 XXC 12-14	0934-6027
OUTLANDER DPS 850 EFI 17	0934-6027
OUTLANDER MAX DPS 850 EFI 17	0934-6027
RENEGADE 850 16-17	0934-6027
RENEGADE 850 XXC 16-17	0934-6027
COMMANDER 1000 DPS 16-17	0934-6027
COMMANDER 1000 LTD 16-17	0934-6027
COMMANDER 1000 STD 11-17	0934-6027
COMMANDER 1000 XT 16-17	0934-6027
COMMANDER 1000 XT/LTD/DPS 11-15	0934-6027
COMMANDER 1000 XTP 14-17	0934-6027
COMMANDER MAX 1000 STD 15-16	0934-6027
COMMANDER MAX 1000 XT/DPS/LTD 14-17	0934-6027
COMMANDER MAX 1000 XTP 15	0934-6027
DEFENDER 1000 16-18	0934-6027
DEFENDER 1000 XT/DPS 16-19	0934-6027
DEFENDER MAX 1000 XT/DPS 17	0934-6027
MAVERICK 1000 STD 13	0934-6027
MAVERICK 1000 STD 14-16	0934-6027
MAVERICK 1000 TURBO 17-19	0934-6027
MAVERICK 1000 XC/XXC/DPS 17-19	0934-6027
MAVERICK 1000 XDS-DPS 15	0934-6027
MAVERICK 1000 XMR 14-17	0934-6027
MAVERICK 1000 XRS-DPS 14-15	0934-6027
MAVERICK 1000 XXC 14-15	0934-6027
MAVERICK MAX 1000 DPS 17	0934-6027
MAVERICK MAX 1000 STD 14-16	0934-6027
MAVERICK MAX 1000 TURBO 17-19	0934-6027
MAVERICK MAX 1000 XC/XXC 16	0934-6027
MAVERICK MAX 1000 XDS-DPS 14-15	0934-6027
MAVERICK MAX 1000 XMR 17	0934-6027
MAVERICK MAX 1000 XRS-DPS 14-15	0934-6027
OUTLANDER 1000 EFI 6X6 15	0934-6027
OUTLANDER 1000 STD 4X4 12-15	0934-6027
OUTLANDER 1000 XMR 13-15	0934-6027
OUTLANDER 1000 XT 4X4 12-14	0934-6027
OUTLANDER DPS 1000 EFI 17	0934-6027

FITS MODEL	PART #
EXHAUST GASKETS (CON'T)	
CAN-AM (CON'T)	
OUTLANDER MAX 1000 EFI 15	0934-6027
OUTLANDER MAX 1000 EFI LTD 15	0934-6027
OUTLANDER MAX 1000 STD 4X4 13-14	0934-6027
OUTLANDER MAX 1000 XT 4X4 13-14	0934-6027
OUTLANDER XMR DPS 1000 EFI 17	0934-6027
RENEGADE 1000 12-16	0934-6027
RENEGADE 1000 17	0934-6027
RENEGADE 1000 XMR 16	0934-6027
RENEGADE 1000 XMR 17	0934-6027
RENEGADE 1000 XXC 12-16	0934-6027
RENEGADE 1000 XXC 17	0934-6027
HONDA	
TRX90 93-05	0934-5277
TRX90 06-19	0934-5277
TRX200 90-97	0934-5279
TRX200SX 86-88	0934-5279
ATC250ES 85-87	0934-6030
ATC250SX 85-87	0934-6030
TRX250 FOURTRAX 85-87	0934-6030
TRX250 RECON 97-01	0934-6030
TRX250TE RECON 02-16	0934-5279
TRX250TE RECON 17-19	0934-5279
TRX250TM RECON 02-16	0934-5279
TRX250TM RECON 17-19	0934-5279
TRX300 FOURTRAX 88-00	0934-6030
TRX300FW FOURTRAX 4X4 88-00	0934-6030
TRX300FW FOURTRAX 4X4 77MM OB 88-00	0934-6030
ATC350X 85-86	0934-5273
TRX350 86-87	0934-5273
TRX350D 87-1989	0934-5273
TRX350FE 00-06	0934-6030
TRX350FM FOURTRAX RANCHER 00-06	0934-6030
TRX350TE 00-06	0934-6030
TRX350TM FOURTRAX RANCHER 00-06	0934-6030
TRX400FA 04-07	0934-6030
TRX400FGA FOURTRAX RANCHER 4X4 04-07	0934-6030
TRX400FW FOURTRAX FOREMAN 4X4 95-03	0934-6030
TRX420 FA IRS 09-14	0934-6030
TRX420 FA IRS 15-16	0934-6030
TRX420 FA IRS 17	0934-6030
TRX420 FA SOLID AXLE 14-16	0934-6030
TRX420 FA SOLID AXLE 17-19	0934-6030
TRX420 FE 07-08	0934-6030
TRX420 FE 09-16	0934-6030
TRX420 FE 17	0934-6030
TRX420 FM 07-08	0934-6030
TRX420 FM 09-16	0934-6030
TRX420 FM 17-19	0934-6030
TRX420 FPA IRS 09-14	0934-6030
TRX420 FPA SOLID AXLE 14	0934-6030
TRX420 FPE 09	0934-6030
TRX420 FPE 10	0934-6030
TRX420 FPE 11-13	0934-6030
TRX420 FPM 09-10	0934-6030
TRX420 FPM 11-13	0934-6030
TRX420 TE 07-08	0934-6030
TRX420 TE 09-16	0934-6030
TRX420 TM 07-08	0934-6030
TRX420 TM 09-16	0934-6030
TRX420 TM 17	0934-6030
TRX450ES 98-01	0934-6030
TRX450FE/FM 02-04	0934-6030
TRX450S 98-01	0934-6030
TRX500FA 01-14	0934-6030
TRX500FA 15-19	0934-6030
TRX500FE 05-11	0934-6030
TRX500FE 12-16	0934-6030
TRX500FE 17	0934-6030
TRX500FGA 04-08	0934-6030
TRX500FM 05-11	0934-6030
TRX500FM 12-13	0934-6030
TRX500FM IRS 15-16	0934-6030
TRX500FM IRS 17	0934-6030
TRX500FM SOLID AXLE 14-19	0934-6030
TRX500FPA 09-11	0934-6030

FITS MODEL	PART #
EXHAUST GASKETS (CON'T)	
HONDA (CON'T)	
TRX500FPA 12-14	0934-6030
TRX500FPE 07-11	0934-6030
TRX500FPE 12-13	0934-6030
TRX500FPM 08-11	0934-6030
TRX500FPM 12-13	0934-6030
TRX500TM 05-06	0934-6030
TRX650 RINCON 03-05	0934-5286
TRX680 RINCON 06-19	0934-5286
KAWASAKI	
KVF650 BRUTE FORCE 05-13	0934-5493
KVF650I BRUTE FORCE 06-13	0934-5493
KVF650 PRAIRIE 02-03	0934-5493
KFX 700 V-FORCE 04-09	0934-5493
KVF700 PRAIRIE 04-06	0934-5493
KVF750 BRUTE FORCE 05-12	0934-5493
KVF750 BRUTE FORCE 13-14	0934-5493
KVF750 BRUTE FORCE 15-17	0934-5492
KVF750 BRUTE FORCE EPS 12-14	0934-5493
KVF750 BRUTE FORCE EPS 15-19	0934-5492
TERYX 4 4X4 12-13	0934-5493
TERYX 750 4X4 08-12	0934-5493
TERYX 750 4X4 13	0934-5492
POLARIS	
SPORTSMAN 90 01-04	0934-5277
SPORTSMAN 90 05-06	0934-5277
SPORTSMAN 90 07-13	0934-5277
SPORTSMAN 90 14-16	0934-5277
SPORTSMAN 110 16-19	0934-5277
RANGER RZR 170 09-17	0934-5277
RANGER ETX 325 15-16	0934-6030
SPORTSMAN 450 HD 16-19	0934-6035
SPORTSMAN 550 11-13	0934-6031
SPORTSMAN 550 EPS 10-14	0934-6031
SPORTSMAN 550 X2 10-14	0934-6031
SPORTSMAN 550 XP 13-14	0934-6031
SPORTSMAN FOREST 550 11-14	0934-6031
SPORTSMAN TOURING EPS 550 10-14	0934-6031
SPORTSMAN XP 550 10	0934-6031
SPORTSMAN XP 550 BUILT AFTER 12/1/08 09	0934-6031
SPORTSMAN XP 550 BUILT BEFORE 12/1/08 09	0934-6031
570 ACE EFI 17	0934-5496
RANGER 4X4 570 14-15	0934-5496
RANGER 4X4 570 CREW 14-15	0934-5496
RANGER 4X4 570 FULL SIZE/CREW 15-16	0934-5496
RANGER 4X4 570 FULL SIZE/CREW 17	0934-5496
RZR 570 EFI 12-13	0934-5496
RZR 570 EFI 14	0934-5496
RZR 570 EFI 15	0934-5496
RZR 570 EFI 16-17	0934-5496
SPORTSMAN 570 6X6 17	0934-5496
SPORTSMAN 570 EFI 14-17	0934-6035
SPORTSMAN 570 EFI EPS 14-15	0934-6035
SPORTSMAN 570 EFI EPS FOREST QUAD 15	0934-6035
SPORTSMAN 570 EFI HD 14	0934-5496
SPORTSMAN 570 EFI UTE HD 15-17	0934-6035
SPORTSMAN 570 EFI X2 15-17	0934-6035
SPORTSMAN 570 FOREST 14	0934-6035
SPORTSMAN 570 FOREST EFI EPS 14-15	0934-6035
SPORTSMAN 570 HD 15-19	0934-6035
SPORTSMAN 570 SP 15-17	0934-6035
SPORTSMAN 570 SP EPS TRACTOR 15	0934-6035
SPORTSMAN 570 SP TOURING 15-17	0934-6035
SPORTSMAN 570 TOURING EFI 14-17	0934-6035
SPORTSMAN ACE 570 15	0934-5496
SPORTSMAN 600 4X4 03	0934-6034
SPORTSMAN 600 4X4 05	0934-6034
RANGER 4X4 700 05-09	0934-6034
RANGER 4X4 700 CREW 08-09	0934-6034
RANGER 6X6 700 EFI 06-09	0934-6034
SPORTSMAN 700 4X4 02-03	0934-6034
SPORTSMAN 700 4X4 05-06	0934-6034
SPORTSMAN 700 EFI 05-06	0934-6034
SPORTSMAN MV7 05	0934-6034
RANGER 4X4 800 EFI 10	0934-6034
RANGER 4X4 800 EFI 11-12	0934-6034
RANGER 4X4 800 EFI 13-14	0934-6036

FITS MODEL	PART #
EXHAUST GASKETS (CON'T)	
POLARIS (CON'T)	
RANGER 4X4 800 EFI CREW 10	0934-6034
RANGER 4X4 800 EFI CREW 11-12	0934-6034
RANGER 4X4 800 EFI CREW 13	0934-6036
RANGER 4X4 800 EFI CREW 14	0934-6036
RANGER 4X4 800 EFI MIDSIZE 13-14	0934-6036
RANGER 6X6 800 10	0934-6034
RANGER 6X6 800 11-12	0934-6034
RANGER 6X6 800 13-16	0934-6036
RANGER XP 800 12	0934-6034
RZR 4 800 10	0934-6034
RZR 4 800 11-14	0934-6034
RZR 800 08-09	0934-6034
RZR 800 11	0934-6034
RZR 800 12-14	0934-6034
RZR S 800 09	0934-5498
RZR S 800 11-14	0934-5498
SPORTSMAN 800 EFI 05-09	0934-5498
SPORTSMAN 850 SP 15-17	0934-5273
SPORTSMAN 850 WV 14	0934-5273
SPORTSMAN FOREST 850 11-13	0934-5271
SPORTSMAN FOREST 850 14-15	0934-5273
SPORTSMAN TOURING 850 SP 15-17	0934-5273
SPORTSMAN TOURING EPS 850 10-13	0934-5271
SPORTSMAN TOURING EPS 850 14	0934-5273
SPORTSMAN TOURING EPS 850 HD 13	0934-5271
SPORTSMAN X2 850 11	0934-5271
SPORTSMAN XP 850 09-13	0934-5271
SPORTSMAN XP 850 EPS 10-13	0934-5271
SPORTSMAN XP 850 EPS 14	0934-5273
900 ACE EFI EPS 16-17	0934-5499
RANGER 900 CREW 14-16	0934-5499
RANGER 900 CREW 17	0934-5499
RANGER 900 XP 13-17	0934-5499
RZR 4 XP JAGGED X 13	0934-5494
RZR 4 900 15-17	0934-5499
RZR 4 XP 900 12-14	0934-5494
RZR 900 50 55 INCH 15-19	0934-5499
RZR 900 60 INCH 15-19	0934-5499
RZR XP 900 11-14	0934-5494
GENERAL 1000 EPS 16	0934-5499
GENERAL 1000 EPS 17	0934-5499
GENERAL 4 1000 EPS 17	0934-5499
RZR 1000 60 INCH 16-17	0934-5499
RZR XP 1000 14-15	0934-5499
RZR XP 1000 16-17	0934-5499
RZR XP 1000 TURBO 16	0934-5499
RZR XP 4 1000 14-15	0934-5499
RZR XP 4 1000 16	0934-5499
RZR XP 4 1000 17	0934-5499
SPORTSMAN 1000 XP 15-17	0934-6028
SPORTSMAN TOURING 1000 15-17	0934-6028
SUZUKI	
LT-A50 02-05	0934-5295
LT-80 87-06	0934-5297
ALT-125 1983-86	0934-5281
LT-125 1983-87	0934-5281
ALT-185F 85	0934-5281
LT-185 84-87	0934-5281
LT-230E 87-93	0934-5281
LT-230G 85-86	0934-5281
LT-230S 85-86	0934-5281
LT-230S 1989-90	0934-5281
LT-F230 86	0934-5281
LT-F230 87	0934-5281
LT-250S 1989-90	0934-5281
LT-4WD 250 QUAD RUNNER 87-98	0934-5281
LT-F250 2WD 88-01	0934-5281
LT-F250 OZARK 02-14	0934-5281
LT-F250F 4WD QUAD RUNNER 99-02	0934-5281
LT-300E 87-1989	0934-5281
LT-F300F KING QUAD 99-02	0934-5281
LT-F4WDX KING QUAD 300 91-98	0934-5281
LT-A400 2WD KING QUAD 08-09	0934-5281
LT-A400 EIGER 2WD 02-07	0934-5281
LT-A400F 4WD KING QUAD 08-13	0934-5281
LT-A400F 4WD KING QUAD 14-15	0934-5281

PLOWES
WINCHES
UTV
RACKS
IMPLEMENT & TOWING
LUGGAGE
BODY
CONTROLS
ELECTRICAL
WHEELS & TIRES
SUSPENSION & DRIVE
BRAKING
ENGINE
RIDER
GARAGE
PROMO

ENGINE

FITS MODEL	PART #
EXHAUST GASKETS (CON'T)	
SUZUKI (CON'T)	
LT-A400F 4WD KING QUAD 16	0934-5281
LT-A400F EIGER 4WD 02-07	0934-5281
LT-F400 2WD KING QUAD 08-09	0934-5281
LT-F400 EIGER 2WD 02-07	0934-5281
LT-F400F 4WD KING QUAD 08-12	0934-5281
LT-F400F EIGER 4WD 02-07	0934-5281
LTA-450 X KING QUAD 07-10	0934-5281
LT-A500F QUAD MASTER AUTO 00-01	0934-5281
LT-A500F VINSON 02-07	0934-5281
LT-A500X 09-16	0934-5281
LT-A500XP POWER STEERING 11-16	0934-5281
LT-F500F 98-02	0934-5281
LT-F500F VINSON 03-07	0934-5281
LTA-700 X KING QUAD 05-07	0934-5291
LTV-700F TWIN PEAKS 04-06	0934-5493
LTA-750 X KING QUAD 08-15	0934-5291
LTA-750 XP KING QUAD POWER STEERING 11-16	0934-5291
TEXTRON	
700 TBX 18	0934-5292
ALTERRA 700 18	0934-5292
ALTERRA 700 VLX 18	0934-5292
ALTERRA 700 VLX EPS 18	0934-5292
ALTERRA 700 XT EPS 18	0934-5292
YAMAHA	
YFM80 BADGER 85-01	0934-5275
YFM80 GRIZZLY 05-08	0934-5275
YFM100 87-91	0934-5275
YFA1 89-04	0934-5275
YFM125 GRIZZLY 04-13	0934-5275
YTI-125 80-85	0934-5287
YTM200 EK 83	0934-5287
YTM200 EL 84	0934-5287
YTM200 ERN 85	0934-5287
YTM200 K 83	0934-5287
YTM200L 84	0934-5287
YTM200N 85	0934-5287
YTM225 TRI-MOTO 85-86	0934-5287
YTM225 TRI-MOTO DXK 83-84	0934-5287
YTM225 TRI-MOTO DXL 83-84	0934-5287
YFB250 TIMBERWOLF 92-98	0934-5287
YFB250FW TIMBERWOLF 94-00	0934-5287
YFM 250 RAPTOR 08-13	0934-5291
YFM250 BEARTRACKER 99-04	0934-5287
YFM250 BIG BEAR 07-09	0934-5287
YFM250 MOTO-4 89-91	0934-5287
YFM250B BRUIN 05-06	0934-5287
YFM350 GRIZZLY IRS 07-11	0934-5291
YFM350 WARRIOR 87-04	0934-5291
YFM350BA BRUIN 2WD 04-06	0934-5291
YFM350ER MOTO-4 87-95	0934-5291
YFM350FA BRUIN 4WD 04-06	0934-5291
YFM350FGW GRIZZLY 4WD 07-14	0934-5291
YFM350FW BIG BEAR 87-96	0934-5291
YFM350FW BIG BEAR 97-99	0934-5291
YFM350GW GRIZZLY 2WD 07-11	0934-5291
YFM350U BIG BEAR 96-99	0934-5291
YFM350FX WOLVERINE 95-05	0934-5291
YFM350X WOLVERINE 06-09	0934-5291
YFP350U TERRA PRO 88	0934-5291
YFM400 BIG BEAR 2WD 00-04	0934-5291
YFM400 BIG BEAR 4WD 00-06	0934-5291
YFM400 BIG BEAR IRS 07-12	0934-5291
YFM400 GRIZZLY IRS 07-08	0934-5291
YFM400 KODIAK 2WD 00-04	0934-5291
YFM400 KODIAK 4WD 93-98	0934-5291
YFM400 KODIAK 4WD 99	0934-5291
YFM400 KODIAK 4WD 00-06	0934-5291
450 RHINO 06-09	0934-5291
YFM450 GRIZZLY EPS 11-14	0934-5291
YFM450 GRIZZLY IRS 07-14	0934-5291
YFM450 KODIAK 03-06	0934-5291
KODIAK 450 18-19	0934-5291
YFM45FX WOLVERINE 450 4X4 06-10	0934-5291
YFM550 GRIZZLY 09-14	0934-5271
YFM550 GRIZZLY EPS 09-14	0934-5271
YFM600 GRIZZLY 98-01	0934-5271

FITS MODEL	PART #
EXHAUST GASKETS (CON'T)	
YAMAHA (CON'T)	
660 RHINO 04-07	0934-5271
YFM660 GRIZZLY 02-08	0934-5271
700 RHINO FI 08-13	0934-5271
KODIAK 700 4WD 16-17	0934-5497
KODIAK 700 EPS 4WD 16-19	0934-5497
VIKING 700 14-15	0934-5271
VIKING 700 16-19	0934-5497
VIKING 700 VI 15	0934-5271
VIKING 700 VI 16-19	0934-5497
WOLVERINE 17	0934-5497
WOLVERINE EPS 17	0934-5497
WOLVERINE R-SPEC EPS 16-17	0934-5497
YFM700 GRIZZLY 07-13	0934-5271
YFM700 GRIZZLY 14-16	0934-5497
YFM700 GRIZZLY EPS 08-13	0934-5271
YFM700 GRIZZLY EPS 14-17	0934-5497
YXZ1000R 16	0934-5495
YXZ1000R EPS 17-19	0934-5495
YXZ1000R EPS SS 17-19	0934-5495

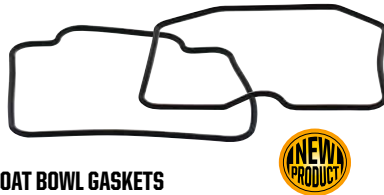

FLOAT BOWL GASKETS

Direct OEM replacement. Sold each.

FITS MODEL	PART #
FLOAT BOWL GASKETS	
ARCTIC CAT	
50 2X4 08	0934-6396
50 Y-6 04-05	0934-6384
50 Y-6 06	0934-6396
90 2-STROKE 02-04	0934-6384
90 UTILITY 2X4 06-16	0934-6396
ALTERRA 90 17	0934-6396
150 UTILITY 09-17	0934-6391
250 (ALL) 99-01	0934-6385
250 2X4 02-05	0934-6386
250 2X4 08-09	0934-6386
250 4X4 02-05	0934-6386
250 2X4 06-07	0934-6391
300 4X4 98-00	0934-6385
300 4X4 01-05	0934-6386
350 CR 12	0934-6387
350 UTILITY 4X4 11	0934-6387
366 FIS W/AT 08-11	0934-6387
375 4X4 W/AT 02	0934-6386
400 2X4 98-01	0934-6385
400 4X4 W/MT 03-04	0934-6386
400 FIS 4X4 W/MT 03	0934-6386
400 4X4 14-15	0934-6387
400 4X4 W/MT 02	0934-6387
400 FIS 2X4 W/MT 04	0934-6387
400 FIS 4X4 TRV 06-14	0934-6387
400 FIS 4X4 W/AT 04-14	0934-6387
400 FIS 4X4 W/MT 02	0934-6387
400 FIS 4X4 W/MT 04-08	0934-6387
400 TBX 4X4 04-06	0934-6387
400 VP 4X4 W/MT 05-06	0934-6387
ALTERRA 400 16-17	0934-6387
454 4X4 96-98	0934-6385
500 4X4 98-99	0934-6385
500 4X4 W/AT 01-02	0934-6387
500 4X4 W/MT 01	0934-6387
500 FIS 4X4 W/AT 02-09	0934-6387
500 FIS 4X4 W/MT 02-09	0934-6387
500 FIS TBX 4X4 02-06	0934-6387

FITS MODEL	PART #
FLOAT BOWL GASKETS (CON'T)	
ARCTIC CAT (CON'T)	
500 FIS TRV 4X4 03-08	0934-6387
650 4X4 (ALL) 05-12	0934-6387
650 4X4 W/AT V2 04-06	0934-6388
CAN-AM	
QUEST 50 03	0934-6384
DS 90 2 STROKE 02-06	0934-6384
RALLY 175 03-07	0934-6397
OUTLANDER 330 04-05	0934-6389
OUTLANDER 400 XT 4X4 03-08	0934-6389
OUTLANDER MAX 400 STD 4X4 05-08	0934-6389
QUEST 500 02-04	0934-6389
TRAXTER 500 AUTO CVT 05	0934-6389
HONDA	
TRX70 86-87	0934-6390
TRX90 93-19	0934-6390
ATC125M 84-85	0934-6390
TRX125 85-86	0934-6390
ATC185 80-83	0934-6391
ATC200 81-83	0934-6391
ATC200E 82-83	0934-6391
ATC200ES 84	0934-6391
ATC200M 84-85	0934-6391
ATC200S 84-86	0934-6391
ATC200X 83-87	0934-6391
TRX200 84-97	0934-6391
TRX200D 90-97	0934-6391
TRX200SX 86-88	0934-6391
ATC250ES 85-87	0934-6392
ATC250SX 85-87	0934-6392
TRX250 FOURTRAX 85-87	0934-6392
TRX250 RECON 97-19	0934-6391
TRX300 FOURTRAX 88-00	0934-6394
TRX300FW FOURTRAX 4X4 88-00	0934-6394
ATC350X 85-86	0934-6392
TRX350 86-87	0934-6392
TRX350D 87-89	0934-6392
TRX350FM FOURTRAX RANCHER 00-06	0934-6394
TRX400FGA FOURTRAX RANCHER 4X4 04-07	0934-6394
TRX400FW FOURTRAX FOREMAN 4X4 95-03	0934-6394
TRX450ES 98-01	0934-6394
TRX450FE/FM 02-04	0934-6394
TRX450S 98-01	0934-6394
TRX500 (ALL) 01-14	0934-6394
TRX650 RINCON 03-05	0934-6394
KAWASAKI	
KLF220 BAYOU 90-02	0934-6397
KLF250 BAYOU 03-11	0934-6397
KEF300 LAKOTA 95-03	0934-6386
KLF300A BAYOU 86-05	0934-6386
KVF300 BRUTE FORCE 12-18	0934-6386
KVF300A PRAIRIE 4X4 99-02	0934-6386
KVF360A PRAIRIE 4X4 03-13	0934-6386
KLF400 BAYOU 93-99	0934-6387
KVF400A PRAIRIE 4X4 97-02	0934-6387
KVF650 BRUTE FORCE (ALL) 05-13	0934-6388
KVF650 PRAIRIE 02-03	0934-6388
KFX 700 V-FORCE 04-09	0934-6388
KVF700 PRAIRIE 04-06	0934-6388
KVF750 BRUTE FORCE 05-07	0934-6388
POLARIS	
RZR 170 09-14	0934-6391
PHOENIX 200 05-19	0934-6391
SAWTOOTH 200 07	0934-6391
BIG BOSS 250 4X6 89-92	0934-6400
BIG BOSS 250 6X6 91-93	0934-6400
TRAIL BLAZER 250 90-06	0934-6400
TRAIL BOSS 250 2X4 86-99	0934-6400
TRAIL BOSS 250 4X4 87-95	0934-6400
XPLORER 250 4X4 00-02	0934-6400
300 2X4 94-95	0934-6400
300 4X4 94-95	0934-6400
BIG BOSS 300 6X6 94	0934-6400
HAWKEYE 2X4 06-11	0934-6385
HAWKEYE 4X4 06-07	0934-6385
SPORTSMAN 300 4X4 08-10	0934-6385
XPLORER 300 4X4 96-99	0934-6400

FITS MODEL	PART #
FLOAT BOWL GASKETS (CON'T)	
POLARIS (CON'T)	
XPRESS 300 96-99	9934-6400
MAGNUM 325 00-02	9934-6385
TRAIL BOSS 325 00-02	9934-6385
XPEDITION 325 00-02	9934-6385
ATP 330 4X4 04-05	9934-6385
MAGNUM 330 (ALL) 03-05	9934-6385
TRAIL BLAZER 330 08-13	9934-6385
TRAIL BOSS 330 03-13	9934-6385
SPORTSMAN 335 99-00	9934-6385
WORKER 335 99	9934-6385
350L 4X4 93	9934-6400
BIG BOSS 350L 6X6 93	9934-6400
SPORTSMAN 350 4X4 93	9934-6400
TRAIL BOSS 350L 4X4 90-92	9934-6400
400L (ALL) 94-95	9934-6400
BIG BOSS 400L 6X6 94-97	9934-6400
HAWKEYE 400 HO 2X4 11-14	9934-6385
MAGNUM 400L 6X6 96-97	9934-6385
RANGER 4X4 400 10-14	9934-6385
SPORTSMAN 400 4X4 94-97	9934-6400
SPORTSMAN 400 4X4 02-14	9934-6385
TRAIL BLAZER 400 03	9934-6400
XPLORER 400L 4X4 95-02	9934-6400
XPRESS 400L 2X4 96-97	9934-6400
MAGNUM 425 4X4 95-02	9934-6385
SPORTSMAN 450 06-07	9934-6385
ATP 500 4X4 05	9934-6399
BIG BOSS 500 6X6 98-02	9934-6385
MAGNUM 500 (ALL) 02-05	9934-6385
RANGER 4X4 500 99-09	9934-6385
RANGER 6X6 500 99-05	9934-6385
SPORTSMAN 500 4X4 96-00	9934-6385
SPORTSMAN 500 6X6 00-08	9934-6385
SPORTSMAN 500 4X4 HO 01-13	9934-6399
WORKER 500 4X4 01	9934-6399
WORKER 500 4X4 99	9934-6385
XPLORER 500 97	9934-6385
SPORTSMAN 600 4X4 03-05	9934-6385
SPORTSMAN 700 4X4 02-07	9934-6385
SUZUKI	
LT-160E 89-92	9934-6401
LT-230E 87-93	9934-6401
LT-230G 85-86	9934-6401
LT-230S 85-90	9934-6401
LT-F230 86-87	9934-6401
LT-250EF 85-86	9934-6401
LT-250S 89-90	9934-6401
LT-4WD 250 QUAD RUNNER 87-89	9934-6401
LT-4WD 250 QUAD RUNNER 90-99	9934-6385
LT-F250 2WD 88-89	9934-6401
LT-F250 2WD 90-99	9934-6385
LT-F250 2WD 00-01	9934-6389
LT-F250F 4WD QUAD RUNNER 99	9934-6385
LT-F250F 4WD QUAD RUNNER 00-02	9934-6389
LT-300E 87-89	9934-6401
LT-F300F KING QUAD 99	9934-6385
LT-F300F KING QUAD 00-02	9934-6389
LT-F4WDX KING QUAD 300 91-98	9934-6385
LT-A400 EIGER (ALL) 02-10	9934-6386
LT-F400F 4WD KING QUAD 08-10	9934-6386
LT-A500F QUAD MASTER AUTO 00-01	9934-6385
LT-F500F 98-02	9934-6385
LT-A500F VINSON 02-07	9934-6386
TEXTRON	
90 DVX 18	9934-6396
ALTERRA 90 18	9934-6396
150 UTILITY 18	9934-6391
ALTERRA 300 18	9934-6386
YAMAHA	
YFA1 89-04	9934-6397
YFM125 GRIZZLY 04-13	9934-6397
YFB250FW TIMBERWOLF 92-00	9934-6397
YFM250 BEARTRACKER 99-04	9934-6385
YFM250 BIG BEAR 07-09	9934-6389
YFM250 MOTO-4 89-91	9934-6397
YFM250B BRUIN 05-06	9934-6389

FITS MODEL	PART #
FLOAT BOWL GASKETS (CON'T)	
YAMAHA (CON'T)	
YFM350 GRIZZLY IRS 07-11	0934-6389
YFM350 WARRIOR 87-04	0934-6402
YFM350FA BRUIN 4WD 04-06	0934-6389
YFM350FGW GRIZZLY 4WD 07-14	0934-6389
YFM350FW BIG BEAR 97-99	0934-6385
YFM350FW BIG BEAR 87-98	0934-6402
YFM35FX WOLVERINE 95	0934-6402
YFM35FX WOLVERINE 96-05	0934-6385
YFM35X WOLVERINE 06-09	0934-6389
YFP350U TERRA PRO 88	0934-6402
YFM400 BIG BEAR 00-12	0934-6389
YFM400 GRIZZLY IRS 07-08	0934-6389
YFM400 KODIAK 4WD 99	0934-6385
YFM400 KODIAK 00-06	0934-6389
YFM400 KODIAK 4WD 93-98	0934-6402
450 RHINO 06-09	0934-6389
YFM450 GRIZZLY EPS 11-14	0934-6389
YFM450 KODIAK 03-06	0934-6389
YFM45FX WOLVERINE 450 4X4 06-10	0934-6389
YFM600 GRIZZLY 98-01	0934-6399
660 RHINO 04-07	0934-6389
YFM660 GRIZZLY 02-08	0934-6389

CRANKSHAFT BEARINGS

OEM matched, high-quality bearing/seal kit. Includes all bearings and seals required to do a crank at a fraction of OEM cost.



FITS MODEL	PART #
CRANKSHAFT BEARINGS	
HONDA	
ATC70 73-85	A24-1031 ¹
TRX70 86-87	A24-1031 ¹
TRX90 93-16	A24-1031 ¹
TRX250 RECON 97-16	0924-0050 ¹
KAWASAKI	
KLF110 87-88	A24-1031 ¹
KLT110 84-86	A24-1031 ¹
KLT200B 83	A24-1042
KLT200C 83-84	A24-1042
KLF220 BAYOU 88-02	A24-1042
KLF250 BAYOU 03-11	A24-1042
KLT250C 83-85	A24-1042
KLF300A BAYOU 86-87	A24-1042
KLF300B BAYOU 88-91	A24-1042
POLARIS	
SPORTSMAN 90 01-06	0924-0048
SPORTSMAN 90 07-14	A24-1031 ¹
400L 2X4 94-95	0924-0049
400L 4X4 94	0924-0049
SPORTSMAN 400 4X4 94-97	0924-0049
TRAIL BLAZER 400 03	0924-0049
XPLORER 400L 4X4 95-02	0924-0049
XPRESS 400L 2X4 96-97	0924-0049
XPEDITION 425 00-02	0924-0050 ¹
BIG BOSS 400L 6X6 94-97	0924-0049
SUZUKI	
LT-50 84-87	0924-0102
LT-A50 02-05	0924-0102
LT-80 87-06	0924-0113
LT-F400 EIGER 2WD 02-04	0924-0050 ¹
LT-F400 EIGER 2WD 07	0924-0050 ¹
LT-F400F 4WD KING QUAD 08-11	0924-0050 ¹
LT-F400F EIGER 4WD 02-07	0924-0050 ¹

¹ NO SEALS INCLUDED



1902-1378



1902-1379



1902-1380



1902-1381



1902-1382

THERMOSTATS

Exact OEM replacement thermostats. Open and close at OEM temperature. Some models include the sealing gasket. Available for most Polaris ATV/UTV models.

FITS MODEL	PART #
THERMOSTATS	
POLARIS	
ACE 325 14-16	1902-1382
HAWKEYE 325 15	1902-1382
RANGER ETX 15-16	1902-1382
SPORTSMAN ETX 15	1902-1382
HAWKEYE 400 11-14	1902-1378
SPORTSMAN 400 01-05	1902-1378
SPORTSMAN 400 HO 11-14	1902-1378
MAGNUM 425 95-98	1902-1378
XPEDITION 425 00-02	1902-1378
SPORTSMAN 450 06-07	1902-1378
SPORTSMAN 450 16-18	1902-1379
DIESEL 99-01	1902-1378
ATP 500 04-05	1902-1378
BIG BOSS 500 6X6 98-99	1902-1378
MAGNUM 500 99-02	1902-1378
RANGER SERIES 10	1902-1378
RANGER SERIES 11	1902-1378
RANGER 500 99-13	1902-1378
SCRAMBLER 500 97-12	1902-1378
SPORTSMAN 500 96-13	1902-1378
WORKER 500 99-01	1902-1378
XPLORER 500 97	1902-1378
ACE 500 17-18	1902-1379
SPORTSMAN 550 (ALL) 09-14	1902-1381
ACE 570 15-18	1902-1379
RANGER 570 14-18	1902-1379
RZR 570 12-18	1902-1379
SPORTSMAN 570 14-18	1902-1379
SPORTSMAN 600 03-05	1902-1382
RANGER 700 05-09	1902-1382
SPORTSMAN 700 02-08	1902-1382
RANGER 800 11-14	1902-1379
RZR 800 11-14	1902-1379
RANGER 800 10	1902-1382
RZR 800 08-10	1902-1382
SPORTSMAN 800 05-14	1902-1382
ACE 900 16-18	1902-1379
RANGER 900 XP 13-18	1902-1379
RZR 900 15-18	1902-1379
RZR 900 (ALL) 11-14	1902-1380
RANGER 1000 XP 17-18	1902-1379
RZR 1000 (ALL) 14	1902-1380
RZR-4 1000 15	1902-1380

PLOWES
WINCHES
UTV
RACKS
IMPLEMENTES & TOWING
LUGGAGE
BODY
CONTROLS
ELECTRICAL
WHEELS & TIRES
SUSPENSION & DRIVE
BRAKING
ENGINE
RIDER
GARAGE
PROMO

ENGINE

RADIATOR CAPS

Automotive-quality replacement. 13 PSI caps. Stamped steel cap with rubber bottom seal.



FITS MODEL	PART #
RADIATOR CAPS	
ARCTIC CAT	
400 4X4 98-02	1903-0027
450 4X4 10-12	1903-0027
500 4X4 98-09	1903-0027
550 4X4 09-14	1903-0027
650 4X4 04-12	1903-0027
700 4X4 06-18	1903-0027
1000 4X4 09-17	1903-0027
PROWLER 500 14-15	1903-0027
PROWLER 550 09-15	1903-0027
PROWLER 650 06-09	1903-0027
PROWLER 700 07-17	1903-0027
PROWLER 1000 09-17	1903-0027
WILDCAT TRAIL 14-18	1903-0027
WILDCAT 1000 12-18	1903-0027
CAN-AM	
RALLY 03-04	1903-0031
OUTLANDER 330 04-05	1903-0031
OUTLANDER 400 04-14	1903-0031
DS450 08-14	1903-0031
OUTLANDER 450 15-19	1903-0031
OUTLANDER 500 07-15	1903-0031
RENEGADE 500 08-15	1903-0031
OUTLANDER 570 16-19	1903-0031
RENEGADE 570 16-17	1903-0031
DS650 00-07	1903-0031
OUTLANDER 650 06-18	1903-0031
QUEST 02-04	1903-0031
TRAXTER 01-05	1903-0031
COMMANDER 800 11-19	1903-0031
DEFENDER 800 16-19	1903-0031
OUTLANDER 800 06-15	1903-0031
RENEGADE 800 07-15	1903-0031
OUTLANDER 850 16-18	1903-0031
RENEGADE 850 16-18	1903-0031
COMMANDER 1000 11-19	1903-0031
MAVERICK 1000 13-17	1903-0031
MAVERICK X3 17-18	1903-0031
OUTLANDER 1000 12-18	1903-0031
RENEGADE 1000 12-17	1903-0031
POLARIS	
TRAIL BLAZER 250 96-97	1903-0027
XPRESS 300 96-97	1903-0027
HAWKEYE 300 (ALL) 11-15	1903-0028
ACE 325 (2015 IS HD MODEL ONLY) 15-16	1903-0027
ACE 325 14-15	1903-0028
SPORTSMAN 325 ETX 15	1903-0028
350L 93	1903-0027

EXHAUST TIPS

Made from CNC-billet aluminum. 15° angled exhaust port and machined gun barrel divots on the tip. Angle directs exhaust flow down and away from fenders and tailgates. Can be used with or without stock spart arrester. Made in the USA.

FITS MODEL	PART #
EXHAUST TIPS	
HONDA	
TRX500 FOREMAN 05-08	1861-0482
TRX500 RUBICON 01-08	1861-0482
KAWASAKI	
TERYX 750 08-12	1861-0481
YAMAHA	
YFM350 BRUIN 04-09	1861-0374
GRIZZLY 350 07-12	1861-0374
GRIZZLY 400/450 07-13	1861-0374
KODIAK 400/450 03-09	1861-0374
RHINO 450 04-09	1861-0374
GRIZZLY 550 09-12	1861-0483
GRIZZLY 660 02-08	1861-0374
RHINO 660 04-07	1861-0374
GRIZZLY 700 07-12	1861-0483
RHINO 700 08-13	1861-0485

FITS MODEL	PART #
RADIATOR CAPS (CON'T)	
POLARIS (CON'T)	
TRAIL BOSS 350L 90-92	1903-0027
400L 94-95	1903-0027
BIG BOSS 400L 95-97	1903-0027
RANGER 400 HO 10-14	1903-0027
SCRAMBLER 400 95-00	1903-0027
SPORT 400 94-99	1903-0027
SPORTSMAN 400L 93-97	1903-0027
XPLORER 400 95-00	1903-0027
XPRESS 400 96-97	1903-0027
SPORTSMAN 400 01-04	1903-0028
SPORTSMAN 400 HO 08-14	1903-0028
MAGNUM 425 95-98	1903-0027
XPEDITION 425 00-02	1903-0028
SPORTSMAN 450 06-07	1903-0028
SPORTSMAN 450 HO 16-18	1903-0028
DIESEL 455 99	1903-0027
DIESEL 455 00-01	1903-0028
ACE 500 17-18	1903-0027
BIG BOSS 500 6X6 98-99	1903-0027
MAGNUM 500 99	1903-0027
RANGER 500 99, 07-11	1903-0027
SCRAMBLER 500 97-01, 10-12	1903-0027
SPORTSMAN 500 96-99	1903-0027
WORKER 500 99	1903-0027
XPLORER 500 97	1903-0027
ATP 500 04-05	1903-0028
MAGNUM 500 00-02	1903-0028
SPORTSMAN 500 00-13	1903-0028
WORKER 500 01	1903-0028
SPORTSMAN 550 09-14	1903-0027
ACE 570 15-18	1903-0027
RANGER 570 14-15	1903-0027
RZR 570 12-18	1903-0027
SPORTSMAN 570 14-18	1903-0028
SPORTSMAN 600 03-05	1903-0028
RANGER 700 07-09	1903-0027
SPORTSMAN 700 02-07	1903-0028
RANGER 800 12-14	1903-0027
RZR 800 12-14	1903-0027
RZR 800 08-11	1903-0028
SPORTSMAN 800 05-14	1903-0028
SCRAMBLER 850 13-18	1903-0027
SPORTSMAN 850 09-18	1903-0027
ACE 900 16-18	1903-0027
RANGER 900 XP 13-18	1903-0027
RZR 900 12-18	1903-0027
RZR 900 11	1903-0028
GENERAL 1000 16-18	1903-0027
RANGER 1000 XP 17-18	1903-0027
RANGER 1000 DIESEL 15-18	1903-0027
RZR 1000 14-18	1903-0027
RZR 1000 TURBO 16-18	1903-0027
SCRAMBLER 1000 14-18	1903-0027
SPORTSMAN 1000 15-18	1903-0027



PULL START REBUILD KITS

Made to repair the pull start mechanism in Polaris ATVs. Kit includes the starter reel, return spring, ratchet, friction spring, friction plate, spring, bushing, recoil gasket and rope assembly.

FITS MODEL	PART #
PULL START REBUILD KITS	
CF MOTO	
CF500 ALL MODELS 07-14	0936-0027
TERRALANDER 500 ALL MODELS 11-14	0936-0027
TERRALANDER 625 11-14	0936-0027
POLARIS	
300 2X4 / 4X4 / 6X6 94	0936-0016
HAWKEYE 300 2X4 06-10	0936-0016
HAWKEYE 300 4X4 06-07	0936-0016
SPORTSMAN 300 4X4 08-10	0936-0016
TRAIL BOSS 300 2X4 95	0936-0016
TRAIL BOSS 300 4X4 95	0936-0016
XPLORER 300 4X4 96-99	0936-0016
XPRESS 300 96-99	0936-0016
MAGNUM 325 2X4 00-02	0936-0016
MAGNUM 325 4X4 00-02	0936-0016
TRAIL BOSS 325 00-02	0936-0016
XPEDITION 325 00-01	0936-0016
ATP330 4X4 04-05	0936-0016
MAGNUM 330 2X4 03-05	0936-0016
MAGNUM 330 4X4 03-06	0936-0016
TRAIL BLAZER 330 09-10	0936-0016
TRAIL BOSS 330 03-10	0936-0016
SPORTSMAN 335 99-00	0936-0016
WORKER 335 99	0936-0016
400L 2X4 94	0936-0016
400L 4X4 94	0936-0016
400L 6X6 94	0936-0016
BIG BOSS 400L 6X6 95-97	0936-0016
SPORTSMAN 400 4X4 94-97	0936-0016
SPORTSMAN 400 4X4 01-04	0936-0016
SPORTSMAN 400 HO 4X4 08	0936-0016
TRAIL BLAZER 400 03	0936-0016
XPLORER 400 4X4 95-96	0936-0016
XPLORER 400 4X4 98-02	0936-0016
XPRESS 400L 96-97	0936-0016
MAGNUM 425 2X4 95-98	0936-0016
MAGNUM 425 4X4 95-98	0936-0016
MAGNUM 425 6X6 96-97	0936-0016
XPEDITION 425 00-02	0936-0016
SPORTSMAN 450 06-07	0936-0016
ATP500 4X4 04-05	0936-0016
BIG BOSS 500 6X6 98-99	0936-0016
MAGNUM 500 4X4 99-03	0936-0016
SPORTSMAN 500 4X4 96-00	0936-0016
SPORTSMAN 500 6X6 00-08	0936-0016
SPORTSMAN 500 HO 4X4 01-06	0936-0016
SPORTSMAN 500 HO 4X4 08	0936-0016
SPORTSMAN 500 EFI HO 4X4 06-08	0936-0016
SPORTSMAN 500 EFI X2 06-08	0936-0016
WORKER 500 99-02	0936-0016
XPLORER 500 97	0936-0016
YAMAHA	
YFM350 BIG BEAR 87-94	0936-0028
YFM350 BIG BEAR 2WD 96-99	0936-0028
YFM350 BIG BEAR 4WD SE 97	0936-0028
YFM350 BIG BEAR 4X4 95-99	0936-0028
YFP350 TERRAPRO 88-89	0936-0028
YFM400 KODIAK 93-99	0936-0028



1861-0482



1861-0481



1861-0374



1861-0483



CHOKE PLUNGER KITS

Includes necessary O-rings, springs, retaining nut, boots and cable guide as necessary. Choke plungers can seize or can easily be lost during a carburetor rebuild. Improperly functioning parts can cause hard starting or poor running conditions. Models with multiple carbs include components to repair each choke plunger.

FITS MODEL	PART #
CHOKE PLUNGER KITS	
HONDA	
ATC250ES 85	1003-1783
ATC250ES 86-87	1003-1782
ATC250SX 85	1003-1783
ATC250SX 86-87	1003-1782
TRX250 FOURTRAX 85	1003-1783
TRX250 FOURTRAX 86-87	1003-1782
TRX300 FOURTRAX 88-93	1003-1783
TRX300 FOURTRAX 94-00	1003-1784
TRX300FW FOURTRAX 4X4 88-93	1003-1783
TRX300FW FOURTRAX 4X4 94-00	1003-1784
TRX350FE 00-06	1003-1784
TRX350FM FOURTRAX RANCHER 00-06	1003-1784
TRX350TE 00-06	1003-1784
TRX350TM FOURTRAX RANCHER 00-06	1003-1784
TRX400FA 04-07	1003-1785
TRX400FGA FOURTRAX RANCHER 4X4 04-07	1003-1785
TRX400FW FOURTRAX FOREMAN 4X4 95-03	1003-1784
TRX450ES 98-01	1003-1784
TRX450FE 02-04	1003-1784
TRX450FM 02-04	1003-1784
TRX450S 98-01	1003-1784
TRX500FA 01-14	1003-1785
TRX500FE 05-11	1003-1785
TRX500FGA 04-08	1003-1785
TRX500FM 05-11	1003-1785
TRX500FPA 09-14	1003-1785
TRX500FPE 07-11	1003-1785
TRX500FPM 08-11	1003-1785
TRX500TM 05-06	1003-1785
KAWASAKI	
KLF220 BAYOU 90-02	1003-1788
KLF250 BAYOU 03-11	1003-1788
KEF300 LAKOTA 95-03	1003-1789
KLF300B BAYOU 88-05	1003-1789
KLF300C BAYOU 4X4 89-05	1003-1789
KVF300 BRUTE FORCE 12-18	1003-1789
KVF300A PRAIRIE 4X4 99-02	1003-1789
KVF300B PRAIRIE 2X4 99-02	1003-1789
KVF360A PRAIRIE 4X4 03-13	1003-1789
KVF360B PRAIRIE 03-11	1003-1789
KVF360C PRAIRIE 4X4 03-13	1003-1789
KLF400 BAYOU 93-99	1003-1789
KVF400A PRAIRIE 4X4 97-98	1003-1789
KVF400B PRAIRIE 98	1003-1789
KVF400C PRAIRIE 4X4 99-02	1003-1789
KVF400D PRAIRIE 99-02	1003-1789
KVF650 BRUTE FORCE 05-13	1003-1790
KVF650 I BRUTE FORCE 06-13	1003-1790
KVF650 PRAIRIE 02-03	1003-1790
KFX 700 V-FORCE 04-09	1003-1790
KVF700 PRAIRIE 04-06	1003-1790
KVF750 BRUTE FORCE 07	1003-1790
POLARIS	
HAWKEYE 2X4 06-11	1003-1791
HAWKEYE 4X4 06-07	1003-1791
SPORTSMAN 300 4X4 08-10	1003-1791
MAGNUM 325 2X4 00-02	1003-1791
MAGNUM 325 4X4 00-02	1003-1791
MAGNUM 325 4X4 HDS 02	1003-1791
MAGNUM 325 4X4 HDS AA 01	1003-1791

FITS MODEL	PART #
CHOKE PLUNGER KITS (CON'T)	
POLARIS (CON'T)	
MAGNUM 325 4X4 HDS FB 01	1003-1791
TRAIL BOSS 325 00-02	1003-1791
XPEDITION 325 00-02	1003-1791
ATP 330 4X4 04-05	1003-1791
MAGNUM 330 2X4 03-05	1003-1791
MAGNUM 330 4X4 05	1003-1791
MAGNUM 330 4X4 AA AB AC 03-04	1003-1791
MAGNUM 330 4X4 FB 03-04	1003-1791
TRAIL BLAZER 330 08-13	1003-1791
TRAIL BOSS 330 03-13	1003-1791
SPORTSMAN 335 99-00	1003-1791
WORKER 335 99	1003-1791
350L 2X4 93	1003-1793
350L 4X4 93	1003-1793
SPORTSMAN 350 4X4 93	1003-1793
TRAIL BOSS 350L 2X4 90-92	1003-1793
TRAIL BOSS 350L 4X4 90-92	1003-1793
400L 2X4 94-95	1003-1793
400L 4X4 94	1003-1793
HAWKEYE 400 HO 2X4 11-13	1003-1792
SPORTSMAN 400 4X4 94-97	1003-1793
SPORTSMAN 400 4X4 02-05	1003-1791
SPORTSMAN 400 4X4 AA AE AG 04	1003-1791
SPORTSMAN 400 4X4 AQ-AV 04	1003-1791
SPORTSMAN 400 4X4 BUILT AFTER 12/7/00 01	1003-1791
SPORTSMAN 400 4X4 BUILT BEFORE 12/7/00 01	1003-1791
SPORTSMAN 400 HO 4X4 09-14	1003-1791
SPORTSMAN 400 HO 4X4 BUILT AFTER 9/16 08	1003-1791
SPORTSMAN 400 HO 4X4 BUILT BEFORE 9/16 08	1003-1791
TRAIL BLAZER 400 03	1003-1793
XPLOER 400L 4X4 95-02	1003-1793
XPRESS 400L 2X4 96-97	1003-1793
MAGNUM 425 2X4 95-98	1003-1791
MAGNUM 425 4X4 95-98	1003-1791
XPEDITION 425 00-02	1003-1791
SPORTSMAN 450 06	1003-1791
SPORTSMAN 450 BUILT AFTER 7/25/06 07	1003-1791
SPORTSMAN 450 BUILT BEFORE 7/25/06 07	1003-1791
ATP 500 4X4 05	1003-1791
MAGNUM 500 2X4 HDS 02	1003-1791
MAGNUM 500 4X4 00-01	1003-1791
MAGNUM 500 4X4 AA 02	1003-1791
MAGNUM 500 4X4 AB/FB 02	1003-1791
MAGNUM 500 4X4 BUILT BEFORE 9/11/98 99	1003-1791
MAGNUM 500 4X4 HDS AA 01-02	1003-1791
MAGNUM 500 4X4 HDS FB 01	1003-1791
SCRAMBLER 500 2X4 00-08	1003-1791
SCRAMBLER 500 4X4 97-12	1003-1791
SPORTSMAN 500 4X4 96-00	1003-1791
SPORTSMAN 500 4X4 BUILT AFTER 9/98 99	1003-1791
SPORTSMAN 500 4X4 BUILT BEFORE 9/98 99	1003-1791
SPORTSMAN 500 4X4 DUSE 01-02	1003-1791
SPORTSMAN 500 4X4 DUSE HO 01	1003-1791
SPORTSMAN 500 4X4 HO 01-13	1003-1791
SPORTSMAN 500 4X4 HO AA-AC-AE-AG 04	1003-1791
SPORTSMAN 500 4X4 HO AD-AX 04	1003-1791
SPORTSMAN 500 4X4 RSE 00-02	1003-1791
SPORTSMAN 500 4X4 RSE BUILT AFTER 9/98 99	1003-1791
SPORTSMAN 500 4X4 RSE BUILT BEFORE 9/98 99	1003-1791
SPORTSMAN FOREST 500 11-13	1003-1792
SPORTSMAN TOURING 500 10-13	1003-1792
WORKER 500 4X4 01	1003-1791
WORKER 500 4X4 BUILT AFTER 9/98 99	1003-1791
WORKER 500 4X4 BUILT BEFORE 9/98 99	1003-1791
XPLOER 500 97	1003-1791
SPORTSMAN 600 4X4 03-05	1003-1792
SPORTSMAN 600 4X4 BUILT AFTER 10/02/03 04	1003-1792
SPORTSMAN 600 4X4 BUILT BEFORE 10/02/03 04	1003-1792
SPORTSMAN 700 4X4 02-07	1003-1792
SPORTSMAN 700 4X4 BUILT AFTER 10/02/03 04	1003-1792
SPORTSMAN 700 4X4 BUILT BEFORE 10/02/03 04	1003-1792
SPORTSMAN MV7 05	1003-1792
SUZUKI	
LT-4WD 250 QUAD RUNNER 90-98	1003-1787
LT-F250 2WD 90-99	1003-1787
LT-F250 OZARK 02-14	1003-1787

FITS MODEL	PART #
CHOKE PLUNGER KITS (CON'T)	
SUZUKI (CON'T)	
LT-F250F 4WD QUAD RUNNER 99	1003-1787
LT-F300F KING QUAD 99	1003-1787
LT-F4WD KING QUAD 300 91-98	1003-1787
LT-A500F QUAD MASTER AUTO 00-01	1003-1787
LT-F500F 98-02	1003-1787
YAMAHA	
YFM250 BIG BEAR 07-09	1003-1786
YFM250B BRUIN 05-06	1003-1786
YFM350 GRIZZLY IRS 07-11	1003-1786
YFM350BA BRUIN 2WD 04-06	1003-1786
YFM350FA BRUIN 4WD 04-06	1003-1786
YFM350FGW GRIZZLY 4WD 07-14	1003-1786
YFM350GW GRIZZLY 2WD 07-11	1003-1786
YFM35X WOLVERINE 06-09	1003-1786
YFM400 BIG BEAR 2WD 00-04	1003-1786
YFM400 BIG BEAR 4WD 00-06	1003-1786
YFM400 BIG BEAR IRS 07-12	1003-1786
YFM400 GRIZZLY IRS 07-08	1003-1786
YFM400 KODIAK 2WD 00-04	1003-1786
YFM400 KODIAK 4WD 00-06	1003-1786
YFM450 GRIZZLY EPS 11-14	1003-1786
YFM450 GRIZZLY IRS 07-14	1003-1786
YFM450 KODIAK 03-06	1003-1786
YFM45FX WOLVERINE 450 4X4 06-10	1003-1786
YFM600 GRIZZLY 98-01	1003-1786
YFM660 GRIZZLY 02-08	1003-1786

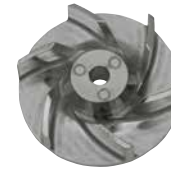

0932-0234



0932-0235



WATER IMPELLER KITS

Replaces the stock, plastic unit with a durable, cast aluminum one. Improves water flow. Longer life than OEM pumps.

FITS MODEL	PART #
WATER IMPELLER KITS	
POLARIS	
HAWKEYE 400 HO 2X4 11-14	0932-0234
RANGER 4X4 400 10-14	0932-0234
SPORTSMAN 400 4X4 01-14	0932-0234
MAGNUM 425 2X4/4X4 95-98	0932-0234
SPORTSMAN 450 06-07	0932-0234
DIESEL 455 4X4 99-01	0932-0234
ATP 500 4X4 04-05	0932-0234
BIG BOSS 500 6X6 98-03	0932-0234
MAGNUM 500 99-03	0932-0234
RANGER 2X4/4X4 500 05-09	0932-0234
RANGER 4X4 500 CREW 11-13	0932-0234
RANGER 4X4 500 EFI 06-13	0932-0234
RANGER 6X6 500 98-05	0932-0234
RANGER SERIES 10 4X4 & 6X6 07	0932-0234
RANGER SERIES 11 4X4 & 6X6 07	0932-0234
SCRAMBLER 500 4X4/2X4 97-12	0932-0234
SPORTSMAN 500 (ALL) 4X4 96-13	0932-0234
WORKER 500 4X4 99-02	0932-0234
XPLOER 500 1997	0932-0234
SPORTSMAN 600 4X4 03-05	0932-0235
RANGER 4X4 700(ALL) 06-09	0932-0235
RANGER 6X6 700 EFI 06-09	0932-0235
SPORTSMAN 700 (ALL) 4X4 02-07	0932-0235
SPORTSMAN X2 700 EFI 08	0932-0235
RANGER 4X4 800(ALL) EFI 10-14	0932-0235
RZR 4 800 10-14	0932-0235
RZR 800 08-14	0932-0235
RZR S 800 09-14	0932-0235
SPORTSMAN 800 (ALL) 05-14	0932-0235

ENGINE



1009-0029



1009-0030



1009-0031



1009-0032



1009-0033



1009-0035



1009-0036



1009-0037



1009-0038



1009-0039



1009-0040



1009-0041

FUEL PUMPS

CARBURETED AND EFI. Direct replacement fuel pumps. Available for EFI or carbureted models. Stock flow rates. Pick up screen/filters included.

FUEL PRESSURE REGULATORS

Regulates the fuel delivery to a constant PSI. All regulators are set to the stock pressure settings. Includes a new sealing O-ring. Works in conjunction with corresponding fuel pump.

FUEL PUMP STRAINERS

installs over a small pickup on the fuel pump and is held in place by a press fit retainer. Installs in the stock location and will maintain the proper operation and life of your fuel pump.

FITS MODEL	FUEL PUMP PART #	FUEL PRESSURE REGULATOR PART #	REPLACEMENT STRAINER PART #
FUEL PUMPS/PRESSURE REGULATORS/PUMP STRAINERS			
KAWASAKI			
BRUTE FORCE 750 08-14	1009-0039 1	-	-
MULE 1000, 2500, 2510, 3000, 3010, 3020 MODELS (ALL)	1009-0037	-	-
POLARIS			
RZR 170 09-13	1009-0035	-	-
HAWKEYE 300 09-11	1009-0029	-	-
SPORTSMAN 300 09-10	1009-0029	-	-
MAGNUM 325 00-02	1009-0029	-	-
TRAIL BOSS 325 00-02	1009-0029	-	-
XPEDITION 325/425 00-02	1009-0029	-	-
RANGER ETX 15-16	1009-0032 ¹	-	1009-0045
SPORTSMAN ETX 15	1009-0032 ¹	-	1009-0045
ATP 330 04-05	1009-0029	-	-
MAGNUM 330 03-06	1009-0029	-	-
TRAIL BLAZER 330 08-10	1009-0029	-	-
TRAIL BOSS 330 03-10	1009-0029	-	-
TRAIL BLAZER 330 11-13	1009-0030	-	-
TRAIL BOSS 330 11-13	1009-0030	-	-
WORKER 335/500 99	1009-0029	-	-
SPORTSMAN 335 99-00	1009-0029	-	-
SPORTSMAN 400 01-05, 09-10	1009-0029	-	-
HAWKEYE 400 11-14	1009-0030	-	-
SPORTSMAN 400 HO 11-14	1009-0030	-	-
MAGNUM 425 96-98	1009-0029	-	-



REPLACEMENT CYLINDERS

Replace your damaged or worn OEM cylinder. Made from cast aluminum, nickel silicon carbide plated. Precision machined and honed to OEM stock bore sizes. Extremely durable low friction bore surface allows for greater heat dissipation. Stock OEM appearance. Made in the USA.

DESCRIPTION	PART #
REPLACEMENT CYLINDERS	
KAWASAKI	
BRUTE FORCE 750 05-19 (FRONT CYLINDER ONLY)	0931-0512
BRUTE FORCE 750 05-19 (REAR CYLINDER ONLY)	0931-0513
TERYX 750 08-13 (FRONT CYLINDER ONLY)	0931-0512
TERYX 750 08-13 (REAR CYLINDER ONLY)	0931-0513
POLARIS	
SPORTSMAN 700 04-08	0931-0630
SPORTSMAN 800 05-15	0931-0630
RANGER 700 05-09	0931-0630
RANGER 800 08-16	0931-0630
RZR 800 08-14	0931-0630
RZR 900 / RZR 4 900 14	0931-0661
RZR XP 900 11-13	0931-0661
RZR XP 4 900 12-13	0931-0661
RZR XP MV 900 14-15	0931-0661
RZR XP 1000 14-18	0931-0631
RZR XP 4 1000 15-18	0931-0631
YAMAHA	
GRIZZLY 700 07-15	0931-0455
RHINO 700 08-13	0931-0455
VIKING 700 14-18	0931-0455

FITS MODEL	FUEL PUMP PART #	FUEL PRESSURE REGULATOR PART #	REPLACEMENT STRAINER PART #
FUEL PUMPS/PRESSURE REGULATORS/PUMP STRAINERS (CON'T)			
POLARIS (CON'T)			
SPORTSMAN 450 06-07	1009-0029	-	-
SPORTSMAN 450 16	1009-0032 ¹	-	1009-0045
ATP 500 05	1009-0029	-	-
BIG BOSS 500 6X6 98-99	1009-0029	-	-
MAGNUM 500 99-02	1009-0029	-	-
RANGER 500 99-08	1009-0038	-	-
SPORTSMAN 500 96-09	1009-0029	-	-
XPLORER 500 97	1009-0029	-	-
SPORTSMAN 500 HO (INCLUDING TOURING) 11-13	1009-0030	-	-
SPORTSMAN 500 EFI 06	1009-0031 ¹	1009-0040	1009-0043
RANGER 500 EFI 06-13	1009-0033 ¹	1009-0041	1009-0044
SPORTSMAN 500 EFI 07-08	1009-0033 ¹	1009-0041	1009-0044
SPORTSMAN 550 XP 09-10	1009-0033 ¹	1009-0041	1009-0044
SPORTSMAN 550 11-13	1009-0032 ¹	1009-0042	1009-0045
SPORTSMAN 550 14	1009-0032 ¹	-	1009-0045
RANGER 570 14-18	1009-0032 ¹	-	1009-0045
RZR 570 12-16	1009-0032 ¹	1009-0042	1009-0045
RZR 570 17	1009-0032 ¹	-	1009-0045
SPORTSMAN 570 14-18	1009-0032 ¹	-	1009-0045
SPORTSMAN 600 03-05	1009-0029	-	-
SPORTSMAN 700 02-06	1009-0029	-	-
SPORTSMAN 700 EFI 04-06	1009-0031 ¹	1009-0040	1009-0043
RANGER 700 XP 05	1009-0031 ¹	1009-0040	1009-0043
RANGER 700 06-09	1009-0033 ¹	1009-0041	1009-0044
SPORTSMAN 700 EFI 07	1009-0033 ¹	1009-0041	1009-0044
SPORTSMAN 800 EFI 05-06	1009-0031 ¹	1009-0040	1009-0043
RANGER 800 10	1009-0033 ¹	1009-0041	1009-0044
RANGER 800 11-12	1009-0032 ¹	1009-0042	1009-0045
RZR 800 08-10	1009-0033 ¹	1009-0041	1009-0044
RZR 800 11-14	1009-0032 ¹	1009-0042	1009-0045
SPORTSMAN 800 07-08	1009-0033 ¹	1009-0041	1009-0044
RANGER 800 (INCLUDING 6X6) 11-16	1009-0032 ¹	-	1009-0045
RZR 800 11-14	1009-0032 ¹	-	1009-0045
SPORTSMAN 850 XP 09-10	1009-0033 ¹	1009-0041	1009-0044
SPORTSMAN 850 11-13	1009-0032 ¹	1009-0042	1009-0045
SPORTSMAN 850 14-18	1009-0032 ¹	-	1009-0045
RANGER 900 XP 13-18	1009-0032 ¹	-	1009-0045
RZR 900 11-14	1009-0032 ¹	1009-0042	1009-0045
RZR 900 15-18	1009-0032 ¹	-	1009-0045
RANGER 1000 17	1009-0032 ¹	-	1009-0045
RZR 1000 14-18	1009-0032 ¹	-	1009-0045
SPORTSMAN 1000 15-16	1009-0032 ¹	-	1009-0045
YAMAHA			
RHINO 450 06-09	1009-0036	-	-
RHINO 660 04-07	1009-0036	-	-

¹ EFI FUEL PUMP W/STRAINER

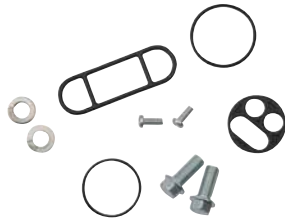

FUEL PETCOCK REBUILD KITS

Includes components to rebuild one fuel petcock. Kits include all necessary face screws, tank bolts, face gasket, tank gasket, diaphragm, O-rings, wave washer and miscellaneous components. Kits for non-rebuildable riveted Honda fuel taps include special drill and self-tapping screws along with instructions for easy and inexpensive rebuild.

FITS MODEL	PART #
FUEL PETCOCK REBUILD KITS	
ARCTIC CAT	
250 2X4 99-00	0705-0477
250 2X4 01-05	0705-0476
250 4X4 01-05	0705-0476
300 2X4 98-00	0705-0477
300 2X4 01-04	0705-0476
300 4X4 98-00	0705-0477
300 4X4 01-05	0705-0476
375 2X4 W/ AT 02	0705-0476
375 4X4 W/ AT 02	0705-0476
400 2X4 98-00	0705-0477
400 2X4 01	0705-0476
400 4X4 98-00	0705-0477
400 4X4 W/ AT 03-04	0705-0476
400 4X4 W/ MT 01-04	0705-0476
400 FIS 2X4 W/ AT 03-04	0705-0476
400 FIS 2X4 W/ MT 03-04	0705-0476
400 FIS 4X4 W/ AT 03-05	0705-0476
400 FIS 4X4 W/ MT 02-05	0705-0476
400 TBX 4X4 04	0705-0476
400 VP 4X4 W/ AT 05-06	0705-0476
400 VP 4X4 W/ MT 05-06	0705-0476
454 2X4 97-98	0705-0477
454 4X4 96-98	0705-0477
500 4X4 98	0705-0477
500 4X4 W/ AT 00-02	0705-0476
500 4X4 W/ MT 00-01	0705-0476
500 FIS 4X4 W/ AT 02-04	0705-0476
500 FIS 4X4 W/ MT 02-04	0705-0476
500 FIS TBX 4X4 02-04	0705-0476
500 FIS TRV 4X4 03-05	0705-0476
CAN-AM	
OUTLANDER 330 04-05	0705-0480
OUTLANDER 330 4X4 05	0705-0480
OUTLANDER 400 03-04	0705-0480
OUTLANDER 400 STD 2X4 05	0705-0480
OUTLANDER 400 STD 4X4 05-08	0705-0480
OUTLANDER 400 XT 4X4 04-08	0705-0480
OUTLANDER MAX 400 STD 4X4 05-08	0705-0480
OUTLANDER MAX 400 XT 4X4 06-08	0705-0480
QUEST 500 02-04	0705-0480
QUEST 500 XT 02-04	0705-0480
TRAXTER 500 99-05	0705-0480
TRAXTER 500 AUTO CVT 05	0705-0480
QUEST 650 STD / XT 04	0705-0480
TRAXTER 650 04-05	0705-0480
TRAXTER 650 AUTO CVT 05	0705-0480
HONDA	
ATC185 80-83	0705-0403
ATC200 81-83	0705-0403
ATC200E 82-83	0705-0403
ATC200ES 84	0705-0403
ATC200M 84-85	0705-0403
ATC200S 84-86	0705-0403
ATC250ES 85-87	0705-0386
ATC250R 85-86	0705-0375
ATC250SX 85-87	0705-0386
TRX250 FOURTRAX 85-87	0705-0386

FITS MODEL	PART #
FUEL PETCOCK REBUILD KITS (CON'T)	
HONDA (CON'T)	
TRX250 RECON 97-01	0705-0397
TRX250TE RECON 02-14/16-19	0705-0397
TRX250TM RECON 02-14/16-19	0705-0397
TRX250X 87-88/91-92	0705-0402
TRX300 FOURTRAX 88-00	0705-0386
TRX300FW FOURTRAX 4X4 88-00	0705-0386
TRX350FE 00-06	0705-0397
TRX350FM FOURTRAX RANCHER 00-06	0705-0397
TRX350TE 00-06	0705-0397
TRX350TM FOURTRAX RANCHER 00-06	0705-0397
TRX400FA 04-07	0705-0397
TRX400FGA FOURTRAX RANCHER 4X4 04-07	0705-0397
TRX400FW FOURTRAX FOREMAN 4X4 95-03	0705-0397
TRX420 FA IRS 09-14	0705-0398
TRX420 FE 07-13	0705-0398
TRX420 FM 07-13	0705-0398
TRX420 FPA IRS 09-14	0705-0398
TRX420 FPE 11-13	0705-0398
TRX420 FPM 11-13	0705-0398
TRX420 TE 07-13	0705-0398
TRX420 TM 07-13	0705-0398
TRX450ES 98-01	0705-0397
TRX450FE/FM 02-04	0705-0397
TRX450S 98-01	0705-0397
TRX500FA 01-04	0705-0397
TRX500FA 05-14	0705-0398
TRX500FE 05-11	0705-0398
TRX500FGA 04	0705-0397
TRX500FGA 05-08	0705-0398
TRX500FM 05-11	0705-0398
TRX500FPA 09-12	0705-0398
TRX500FPE 07-11	0705-0398
TRX500FPM 08-11	0705-0398
TRX500TM 05-06	0705-0398
TRX650 RINCON 03-05	0705-0397
KAWASAKI	
KFX50 07-09/13-19	0705-0491
KFX90 07-10	0705-0491
KFX90 11-19	0705-0491
KLT185 86-87	0705-0366
KLF220 BAYOU 88-02	0705-0489
KLF250 BAYOU 03-11	0705-0489
KLF300A BAYOU 86-87	0705-0489
KLF300B BAYOU 88-05	0705-0489
KLF300C BAYOU 4X4 89-05	0705-0489
KVF300A PRAIRIE 4X4 99-02	0705-0490
KVF300B PRAIRIE 2X4 99-02	0705-0490
KVF360A PRAIRIE 4X4 03-12	0705-0361
KVF360B PRAIRIE 03-11	0705-0361
KVF360C PRAIRIE 4X4 03-12	0705-0361
KLF400 BAYOU 93-99	0705-0489
KVF400A PRAIRIE 4X4 97-98	0705-0361
KVF400B PRAIRIE 98	0705-0361
KVF400C PRAIRIE 4X4 99-02	0705-0361
KVF400D PRAIRIE 99-02	0705-0361
KVF650 BRUTE FORCE 05	0705-0488
KVF650 BRUTE FORCE 06-13	0705-0396
KVF650 I BRUTE FORCE 06-13	0705-0396
KVF650 PRAIRIE 02-06	0705-0488
KVF750 BRUTE FORCE 05-07	0705-0396
POLARIS	
SPORTSMAN 450 06-07	0705-0478
SPORTSMAN 500 4X4 HO 06-08	0705-0478
SPORTSMAN 700 4X4 06	0705-0478
SUZUKI	
LT-4WD 250 QUAD RUNNER 95-98	0705-0485
LT-F250 2WD 95-01	0705-0485
LT-F250 OZARK 02-06	0705-0479
LT-F250 OZARK 07-08/12-14	0705-0492
LT-F250F 4WD QUAD RUNNER 99-00	0705-0486
LT-F250F 4WD QUAD RUNNER 01-02	0705-0485
LT-F300F KING QUAD 99-00	0705-0486
LT-F300F KING QUAD 01-02	0705-0485
LT-F4WDX KING QUAD 300 95-98	0705-0485
LT-A400 2WD KING QUAD 08-09	0705-0484
LT-A400 EIGER 2WD 02-04	0705-0483

FITS MODEL	PART #
FUEL PETCOCK REBUILD KITS (CON'T)	
SUZUKI (CON'T)	
LT-A400 EIGER 2WD 06-07	0705-0482
LT-A400F 4WD KING QUAD 08-10	0705-0484
LT-A400F EIGER 4WD 02-04	0705-0483
LT-A400F EIGER 4WD 05-07	0705-0482
LT-F400 2WD KING QUAD 08-09	0705-0484
LT-F400 EIGER 2WD 02-04	0705-0483
LT-F400 EIGER 2WD 07	0705-0482
LT-F400F 4WD KING QUAD 08-10	0705-0484
LT-F400F EIGER 4WD 02-05	0705-0483
LT-F400F EIGER 4WD 06-07	0705-0482
LT-A500F QUAD MASTER AUTO 00-01	0705-0481
LT-A500F VINSON 02-05	0705-0479
LT-A500F VINSON 06-07	0705-0484
LT-F500F 98-00	0705-0487
LT-F500F VINSON 03-07	0705-0479
YAMAHA	
YFM80 BADGER 85-88/92-01	0705-0335
YFM80 GRIZZLY 05-08	0705-0335
YFM100 87-91	0705-0335
YFA1 89-04	0705-0335
YFM125 GRIZZLY 04-13	0705-0335
YFB250 TIMBERWOLF 92-98	0705-0335
YFB250FW TIMBERWOLF 94-00	0705-0335
YFM250 BEARTRACKER 99-04	0705-0335
YFM250 BIG BEAR 07-09	0705-0335
YFM250 MOTO-4 89-91	0705-0335
YFM250B BRUIN 05-06	0705-0335
YFM300 GRIZZLY 12-13	0705-0394
YFM350 GRIZZLY IRS 07-11	0705-0394
YFM350BA BRUIN 2WD 04-06	0705-0394
YFM350ER MOTO-4 87-95	0705-0335
YFM350FA BRUIN 4WD 04-06	0705-0394
YFM350FGW GRIZZLY 4WD 07-14	0705-0394
YFM350FW BIG BEAR 87-99	0705-0335
YFM350GW GRIZZLY 2WD 07-11	0705-0394
YFM350U BIG BEAR 96-99	0705-0335
YFM350FX WOLVERINE 95-05	0705-0335
YFM350X WOLVERINE 06-09	0705-0474
YFM400 BIG BEAR 2WD 00-04	0705-0335
YFM400 BIG BEAR 4WD 00-06	0705-0335
YFM400 BIG BEAR IRS 07-12	0705-0335
YFM400 GRIZZLY IRS 07-08	0705-0394
YFM400 KODIAK 2WD 00-04	0705-0394
YFM400 KODIAK 4WD 93-99	0705-0335
YFM400 KODIAK 4WD 00-06	0705-0394
YFM450 GRIZZLY EPS 11-14	0705-0393
YFM450 GRIZZLY IRS 07	0705-0393
YFM450 GRIZZLY IRS 08-14	0705-0394
YFM450 KODIAK 03-06	0705-0394
YFM450FX WOLVERINE 450 4X4 06-10	0705-0473
YFM600 GRIZZLY 98	0705-0335
YFM600 GRIZZLY 99-01	0705-0472
YFM660 GRIZZLY 02-08	0705-0392



CARBURETOR PRIMER PUMP KIT

OEM replacement carburetor primer pump.

FITS MODEL	PART #
FITS MOST HONDA AND KAWASKI MODELS	1009-0034

ENGINE



AIR CUT OFF VALVE REBUILD KITS

Includes all necessary parts to rebuild the air cut off valve circuit. ATV or motorcycle models with multiple carburetors include components to repair all carburetors. Includes necessary O-rings, diaphragm, spring, screws. Improperly functioning air cut off valves can stick open or closed causing popping on deceleration or poor running conditions.

FITS MODEL	PART #
AIR CUT OFF VALVE REBUILD KITS	
KAWASAKI	
KVF650 BRUTE FORCE 05-13	1003-1284
KVF650 PRAIRIE 02-03	1003-1284
KFX700 V-FORCE 04-09	1003-1285
KVF700 PRAIRIE 04-06	1003-1285
KVF750 BRUTE FORCE 05-06	1003-1285
SUZUKI	
LT-F250 QZARK 02-14	1003-1277
LT-A400 2WD KING QUAD 08-09	1003-1283
LT-A400 EIGER 2WD 02-04	1003-1283
LT-A400 EIGER 2WD 07	1003-1283
LT-A400F 4WD KING QUAD 08-10	1003-1283
LT-A400F EIGER 4WD 02-07	1003-1283
LT-F400 2WD KING QUAD 08-09	1003-1283
LT-F400 EIGER 2WD 02-04	1003-1283
LT-F400 EIGER 2WD 07	1003-1283
LT-F400F EIGER 4WD 02-06	1003-1283
LT-F400F 4WD KING QUAD 08-10	1003-1283
LT-A500F VINSON 02-07	1003-1283
LT-F500F VINSON 03-07	1003-1283
YAMAHA	
YFM250 BIG BEAR 07-09	1003-1276
YFM250 RAPTOR 08-13	1003-1277
YFM250 BEARTRACKER 99-04	1003-1278
YFM350 GRIZZLY IRS 07-11	1003-1276
YFM350BA BRUIN 2WD 04-06	1003-1276
YFM350FA BRUIN 4WD 04-06	1003-1276
YFM350FGW GRIZZLY 4WD 07-14	1003-1276
YFM350GW GRIZZLY 2WD 07-11	1003-1276
YFM35X WOLVERINE 06-09	1003-1276
YFM350 WARRIOR 87-04	1003-1278
YFM350FW BIG BEAR 99	1003-1278
YFM350ER MOTO-4 87-95	1003-1280
YFM350FW BIG BEAR 87-98	1003-1280
YFM350U BIG BEAR 96-99	1003-1280
YFM35FX WOLVERINE 95-05	1003-1280
YFM400 BIG BEAR 2WD 00-04	1003-1276
YFM400 BIG BEAR 4WD 00-06	1003-1276
YFM400 BIG BEAR IRS 07-12	1003-1276
YFM400 KODIAK 2WD 00-01	1003-1276
YFM400 KODIAK 4WD 93-97	1003-1280
YFM400 KODIAK 4WD 98-99	1003-1278
YFM400 KODIAK 4WD 00	1003-1277
YFM400 KODIAK 4WD 01-02	1003-1276
YFM400 GRIZZLY IRS 07-08	1003-1282
YFM400 KODIAK 2WD 03-04	1003-1282
YFM400 KODIAK 4WD 03-06	1003-1282
YFM450 GRIZZLY EPS 11-14	1003-1282
YFM450 GRIZZLY IRS 07	1003-1282
YFM450 GRIZZLY IRS 08-14	1003-1282
YFM450 KODIAK 03-06	1003-1282
YFM45FX WOLVERINE 450 4X4 06-10	1003-1282
YFM660 GRIZZLY 02-08	1003-1277

WATER PUMP REBUILD KITS

Includes every gasket, O-ring, bearing and seal required to rebuild a water pump.



FITS MODEL	PART #
WATER PUMP REBUILD KITS	
CAN-AM	
OUTLANDER 500 STD 4X4 07-15	9334-4862
OUTLANDER MAX 500 STD 4X4 07-14	9334-4862
TRAXTER 500 99-05	9334-4862
OUTLANDER 570 EFI (ALL) 16-19	9334-4862
OUTLANDER 650 (ALL) 15-19	9334-4862
COMMANDER 800 13-19	9334-4862
COMMANDER MAX 800 DPS 16-19	9334-4862
DEFENDER 800 16-19	9334-4862
DEFENDER MAX 800 DPS 17-19	9334-4862
MAVERICK TRAIL 800R 18-19	9334-4862
OUTLANDER 800 (ALL) 4X4 06-15	9334-4862
OUTLANDER MAX 800 (ALL) 4X4 07-15	9334-4862
OUTLANDER 850 DPS 16-19	9334-4862
OUTLANDER MAX 850 DPS 16-19	9334-4862
COMMANDER 1000 STD 11-18	9334-4862
COMMANDER MAX 1000 LTD 15-18	9334-4862
DEFENDER 1000 16-18	9334-4862
DEFENDER MAX 1000 DPS 17-18	9334-4862
MAVERICK 1000 STD 13-18	9334-4862
MAVERICK MAX 1000 STD 14-18	9334-4862
MAVERICK TRAIL 1000 18	9334-4862
OUTLANDER 1000 DPS 12-18	9334-4862
OUTLANDER MAX 1000 13-18	9334-4862
RENEGADE 1000 12-18	9334-4862
HONDA	
TRX420 FA IRS 17-19	9334-4858
TRX420 FA SOLID AXLE 17-19	9334-4858
TRX420 FM 07-19	9334-4858
TRX420 FA IRS 09-16	9334-4861
TRX420 FA SOLID AXLE 14-16	9334-4861
PIONEER 500 15-19	9334-4868
TRX500FA 15-19	9334-4858
TRX500FE 14-19	9334-4858
TRX500FM IRS 17-19	9334-4858
TRX500FM SOLID AXLE 14-19	9334-4858
TRX650 RINCON 03-05	9334-4867
TRX680 RINCON 06-19	9334-4867
BIG RED MUV 700 09-13	9334-4867
PIONEER 700 14-19	9334-4867
KAWASAKI	
KVF650 BRUTE FORCE 05-13	9334-4850
KVF650 PRAIRIE 02-03	9334-4850
KFX700 V-FORCE 04-09	9334-4850
KVF700 PRAIRIE 04-06	9334-4850
KVF750 BRUTE FORCE 05-19	9334-4850
TERYX 750 4X4 08-13	9334-4850
POLARIS	
400L (ALL) 94-95	9334-4841
BIG BOSS 400L 6X6 94-97	9334-4841
HAWKEYE 400 HO 2X4 11-14	9334-4851
MAGNUM 400L 6X6 96-97	9334-4841
RANGER 4X4 400 10-14	9334-4851
SPORTSMAN 400 4X4 94-97	9334-4841
SPORTSMAN 400 4X4 02-05	9334-4851
SPORTSMAN 400 HO 4X4 08-14	9334-4851
TRAIL BLAZER 400 03	9334-4841
XPLORER 400L 4X4 95-02	9334-4841
MAGNUM 425 4X4 95-98	9334-4851
XPEDITION 425 00-02	9334-4851
SPORTSMAN 450 06-07	9334-4851
ATP 500 4X4 04-05	9334-4851
BIG BOSS 500 6X6 98-03	9334-4851
MAGNUM 500 4X4 00-02	9334-4851
RANGER 4X4 500 99-06	9334-4851
RANGER 4X4 500 CREW 11-13	9334-4851
RANGER 4X4 500 EFI 06-13	9334-4851
RANGER 6X6 500 98-05	9334-4851
SPORTSMAN 500 4X4 96-08	9334-4851

FITS MODEL	PART #
WATER PUMP REBUILD KITS (CON'T)	
POLARIS (CON'T)	
SPORTSMAN 500 X2 06-09	9334-4851
SPORTSMAN TOURING 500 08-13	9334-4851
SPORTSMAN 550 11-13	9334-4865
SPORTSMAN 550 X2 10-14	9334-4865
SPORTSMAN 550 XP 10-14	9334-4865
SPORTSMAN TOURING 550 EPS 10-14	9334-4865
RANGER 4X4 700 05-09	9334-4860
SPORTSMAN 700 4X4 05-07	9334-4860
SPORTSMAN X2 700 EFI 08	9334-4860
RANGER 4X4 800 EFI 10	9334-4860
RANGER 4X4 800 EFI 11-14	9334-4863
RANGER 4X4 800 EFI MIDSIZE 13-14	9334-4863
RANGER 6X6 800 10	9334-4860
RANGER 6X6 800 11-16	9334-4863
RANGER XP 800 12	9334-4863
RZR 800 08-10	9334-4860
RZR S 800 09	9334-4860
RZR 4 800 11-14	9334-4863
RZR S 800 11-14	9334-4863
RZR S 800 11-14	9334-4863
SPORTSMAN 800 EFI 05-10	9334-4860
SPORTSMAN 800 EFI 11-14	9334-4863
SPORTSMAN TOURING 800 EFI 08-09	9334-4860
SPORTSMAN X2 800 EFI 07-09	9334-4860
SPORTSMAN 850 SP 15-16	9334-4864
SPORTSMAN 850 WV 14	9334-4864
SPORTSMAN 850 XP HO EPS 14-16	9334-4864
SPORTSMAN X2 850 11	9334-4864
SPORTSMAN XP 850 EPS 09-14	9334-4864
ACE 900 EPS XC 17-19	9334-5502
RANGER 900 CREW 14-15	9334-4866
RANGER 900 XP 13-15	9334-4866
RANGER 900 CREW 16-19	9334-5502
RANGER 900 CREW EPS 16-19	9334-5502
RANGER 900 XP 16-19	9334-5502
RZR 4 900 15	9334-4866
RZR 4 XP 900 12-14	9334-4866
RZR 4 900 16-18	9334-5502
RZR 900 50 55 INCH 15	9334-4866
RZR XP 900 11-14	9334-4866
RZR 900 50 INCH 18-19	9334-5502
RZR 900 60 INCH 16	9334-5502
RZR 900 60 INCH 18-19	9334-5502
GENERAL 1000 EPS 16-19	9334-5502
RANGER 1000 EPS BASE 18-19	9334-5502
RANGER XP 1000 EPS CREW 19	9334-5502
RANGER XP 1000 EPS CREW NSTR 19	9334-5502
RZR 1000 60 INCH 16-19	9334-5502
RZR RS1 18-19	9334-5502
RZR XP 1000 14-15	9334-4866
RZR S4 1000 19	9334-5502
RZR XP 1000 17-19	9334-5502
RZR XP 4 1000 17-19	9334-5502
RZR XP 4 TURBO 16-19	9334-5502
RZR XP TURBO 16-19	9334-5502
RZR XP TURBO S 18-19	9334-5502
RZR XP TURBO S4 19	9334-5502
SPORTSMAN 1000 XP 15-16	9334-4864
SPORTSMAN TOURING 1000 15-17	9334-4864
SUZUKI	
LTV-700F TWIN PEAKS 04-06	9334-4850
YAMAHA	
YFM400 GRIZZLY IRS 07-08	9334-4849
YFM400 KODIAK 4WD 00-06	9334-4849
450 RHINO 06-09	9334-4849
YFM450 GRIZZLY IRS 07-14	9334-4849
YFM450 KODIAK 03-06	9334-4849
YFM45FX WOLVERINE 450 4X4 06-10	9334-4849
YFM550 GRIZZLY 09-14	9334-4857
660 RHINO 04-07	9334-4846
YFM660 GRIZZLY 02-08	9334-4846
700 RHINO FI 08-13	9334-4857
VIKING 700 14-19	9334-4857
YFM700 GRIZZLY 07-15	9334-4857

MECHANICAL WATER PUMP SEALS

High quality mechanical water pump seals now available separately. Enhances our existing complete gasket kit.



FITS MODEL	PART #
MECHANICAL WATER PUMP SEALS	
ARCTIC CAT	
400 4X4 98-00	0935-0854
400 4X4 W/MT 01-02	0935-0854
454 4X4 96-98	0935-0854
500 4X4 W/AT 00-02	0935-0854
500 FIS 4X4 W/AT 02-09	0935-0854
650 4X4 H1 07-11	0935-0854
650 4X4 W/AT V2 04-06	0935-0852
650 H1 LTD 05-07	0935-0854
650 H1 MUDPRO 10-11	0935-0854
650 TRV 07-08	0935-0854
700 EFI 07-08	0935-0854
700 LTD 06-07	0935-0854
WILDCAT TRAIL 17	0935-0852
1000 H2 THUNDERCAT 08-10	0935-0854
CAN-AM	
OUTLANDER 500 LTD 4X4 10	0935-0857
OUTLANDER 500 STD 4X4 07-15	0935-0857
OUTLANDER 500 XT 4X4 07-14	0935-0857
OUTLANDER L 500 EFI 15	0935-0857
OUTLANDER L MAX 500 EFI 15	0935-0857
OUTLANDER MAX 500 EFI 07-15	0935-0857
TRAXTER 500 99-05	0935-0857
OUTLANDER DPS 570 EFI 16-19	0935-0857
OUTLANDER L 570 EFI 16	0935-0857
OUTLANDER LE 570 EFI 16	0935-0857
OUTLANDER MAX 570 EFI 16-19	0935-0857
OUTLANDER STD 570 EFI 17-19	0935-0857
OUTLANDER XMR 570 EFI 16-19	0935-0857
RENEGADE 570 EFI 16-19	0935-0857
RENEGADE XMR 570 EFI 17-19	0935-0857
OUTLANDER 650 06-19	0935-0857
OUTLANDER MAX 650 06-19	0935-0857
OUTLANDER STD 650 EFI 17-19	0935-0857
COMMANDER 800 13-19	0935-0857
COMMANDER MAX 800 DPS 16-19	0935-0857
DEFENDER 800 16-19	0935-0857
DEFENDER MAX 800 DPS 17-19	0935-0857
MAVERICK TRAIL 800R 18-19	0935-0857
OUTLANDER 800 4X4 (ALL) 06-15	0935-0857
OUTLANDER MAX 800 (ALL) 07-15	0935-0857
OUTLANDER 850 16-19	0935-0857
OUTLANDER MAX 850 (ALL) 16-19	0935-0857
COMMANDER 1000 (ALL) 13-19	0935-0857
COMMANDER MAX 1000 (ALL) 15-19	0935-0857
DEFENDER 1000 (ALL) 16-19	0935-0857
DEFENDER MAX 1000 (ALL) 17-19	0935-0857
MAVERICK 1000 (ALL) 13-19	0935-0857
OUTLANDER 1000 12-19	0935-0857
OUTLANDER MAX 1000 13-19	0935-0857
CF-MOTO	
CF500 07-14	0935-0852
RANCHER 500 CF500-5 UTV 11-13	0935-0852
X5 TERRALANDER 500 11-14	0935-0852
RANCHER 600 CF600-5 UTV 11-13	0935-0852
Z6 TERRACROSS 600 11-14	0935-0852
X6 TERRALANDER 625 EFI 11-14	0935-0852
Z6-EX TERRACROSS 625 EX 12-14	0935-0852
TRACKER 800 CF800-3 UTV 13-14	0935-0852
X8 TERRALANDER 800 12-14	0935-0852
Z8-EX TERRACROSS 800 EX 14	0935-0852
C FORCE 500 HO 15	0935-0852
C FORCE 500 S 16-17	0935-0852
C FORCE 500 X5 L CARB 14	0935-0852
C FORCE 500 X5 L EFI 14	0935-0852
C FORCE 500 X5 S CARB 14	0935-0852
C FORCE 500 X5 S EFI 14	0935-0852
C FORCE 500-2 L 11-12	0935-0852
C FORCE 500-2 S 07-14	0935-0852
C FORCE X5 500 L CARB 11-13	0935-0852

FITS MODEL	PART #
MECHANICAL WATER PUMP SEALS (CON'T)	
CF MOTO (CON'T)	
C FORCE X5 500 S CARB 11-13	0935-0852
C FORCE X5 500 S EFI 11-12	0935-0852
C FORCE X6 600 13	0935-0852
C FORCE X6 600 L 11-12	0935-0852
C FORCE X6 600 S 11	0935-0852
C FORCE 500-2A L 07-14	0935-0852
C FORCE X8 X-LANDER 12-14	0935-0852
U FORCE 500 HO 15	0935-0852
U FORCE RANCHER 500 11-13	0935-0852
U FORCE RANCHER 600 11-14	0935-0852
U FORCE TRACKER 800 13-14	0935-0852
Z FORCE 600 11	0935-0852
Z FORCE Z6 13	0935-0852
Z FORCE Z8 16	0935-0852
Z FORCE Z8 EX SPORT 15	0935-0852
Z FORCE Z8 SPORT 15	0935-0852
Z6 SPORT 12-14	0935-0852
Z6-EX SPORT 12-14	0935-0852
Z8-EX SPORT 14	0935-0852
C FORCE 800 15-16	0935-0852
HONDA	
TRX420 RANCHER (ALL) 07-19	0935-0853
PIONEER 500 15-19	0935-0853
TRX500 (ALL) 12-19	0935-0853
TRX650 RINCON 03-05	0935-0853
TRX680 RINCON 06-19	0935-0853
BIG RED MUV 700 09-13	0935-0853
PIONEER 700 14-19	0935-0853
KAWASAKI	
KLF400 BAYOU 93-99	0935-0854
KVF400A PRAIRIE 4X4 97-02	0935-0852
KVF650 BRUTE FORCE 05-13	0935-0852
KVF650 PRAIRIE 02-03	0935-0852
KFX 700 V-FORCE 04-09	0935-0852
KVF700 PRAIRIE 04-06	0935-0852
KVF750 BRUTE FORCE 05-19	0935-0852
TERYX 4 4X4 12-13	0935-0852
TERYX 750 4X4 08-13	0935-0852
TERYX 4X4 800 14-19	0935-0852
POLARIS	
HAWKEYE 400 HO 2X4 11-14	0935-0856
RANGER 4X4 400 10-14	0935-0856
SPORTSMAN 400 4X4 02-05	0935-0856
SPORTSMAN 400 HO 4X4 09-14	0935-0856
MAGNUM 425 4X4 95-98	0935-0856
XPEDITION 425 00-02	0935-0856
SPORTSMAN 450 06	0935-0856
ATP 500 4X4 04-05	0935-0856
BIG BOSS 500 6X6 98-03	0935-0856
MAGNUM 500 01-02	0935-0856
RANGER 4X4 500 99-06	0935-0856
RANGER 4X4 500 CREW 11-13	0935-0856
RANGER 4X4 500 EFI 06-13	0935-0856
RANGER 500 ETX 17	0935-0856
RANGER 6X6 500 98-05	0935-0856
SPORTSMAN 500 4X4 96-13	0935-0856
SPORTSMAN 500 X2 06-09	0935-0856
SPORTSMAN TOURING 500 08-13	0935-0856
XPLORER 500 97	0935-0856
SPORTSMAN 550 EPS 10-14	0935-0856
SPORTSMAN 550 X2 10-14	0935-0856
SPORTSMAN 550 XP 10-14	0935-0856
SPORTSMAN TOURING 550 EPS 10-14	0935-0856
SPORTSMAN 600 4X4 03	0935-0858
SPORTSMAN 600 4X4 05	0935-0858
RANGER 4X4 700 05-09	0935-0858
RANGER 6X6 700 EFI 06-09	0935-0858
SPORTSMAN 700 4X4 02-03	0935-0858
SPORTSMAN 700 4X4 05-07	0935-0858
SPORTSMAN X2 700 EFI 08	0935-0858
RANGER 4X4 800 EFI 10-14	0935-0858
RANGER 4X4 800 EFI CREW 10-14	0935-0858
RANGER 4X4 800 EFI MIDSIZE 13-14	0935-0858
RANGER 6X6 800 10-16	0935-0858
RANGER XP 800 12	0935-0858
RZR 4 800 10-14	0935-0858

FITS MODEL	PART #
MECHANICAL WATER PUMP SEALS (CON'T)	
POLARIS (CON'T)	
RZR 800 08-14	0935-0858
RZR S 800 09	0935-0858
RZR S 800 11-14	0935-0858
SPORTSMAN 800 EFI 05-14	0935-0858
SPORTSMAN 800 EFI 6X6 09-14	0935-0858
SPORTSMAN 800 HO EFI 09	0935-0858
SPORTSMAN TOURING 800 EFI 08-09	0935-0858
SPORTSMAN X2 800 EFI 07-09	0935-0858
SPORTSMAN 850 SP 15-18	0935-0859
SPORTSMAN 850 XP HO EPS MD 15	0935-0859
SPORTSMAN TOURING 850 (ALL) 10-19	0935-0859
SPORTSMAN X2 850 11	0935-0859
SPORTSMAN XP 850 EPS 09-14	0935-0859
ACE 900 EPS XC 16-19	0935-0855
RANGER 900 CREW 14-19	0935-0855
RANGER 900 XP 13-19	0935-0855
RZR 4 900 15-18	0935-0855
RZR 4 XP 900 12-14	0935-0855
RZR 900 50 55 INCH 15-17	0935-0855
RZR 900 50 INCH 18-19	0935-0855
RZR 900 60 INCH 16-19	0935-0855
RZR XP 900 11-14	0935-0855
GENERAL 1000 EPS 16-19	0935-0855
RANGER 1000 EPS BASE 18-19	0935-0855
RANGER XP 1000 EPS CREW 19	0935-0855
RANGER XP 1000 EPS CREW NSTR 19	0935-0855
RZR 1000 60 INCH 16-19	0935-0855
RZR RS1 18-19	0935-0855
RZR S4 1000 19	0935-0855
RZR XP 1000 14-19	0935-0855
RZR XP 4 1000 14-19	0935-0855
RZR XP 4 TURBO 16-19	0935-0855
RZR XP TURBO 16-19	0935-0855
RZR XP TURBO S 18-19	0935-0855
RZR XP TURBO S4 19	0935-0855
SPORTSMAN 1000 XP 15-18	0935-0859
SPORTSMAN TOURING 1000 15-19	0935-0859
SUZUKI	
LTA-450 X KING QUAD 07-10	0935-0854
LT-A500F QUAD MASTER AUTO 00-01	0935-0854
LT-A500F VINSON 02-07	0935-0854
LT-A500X 09-18	0935-0854
LT-F500F 98-02	0935-0854
LT-F500F VINSON 03-07	0935-0854
LTA-700 X KING QUAD 05-07	0935-0854
LTV-700F TWIN PEAKS 04-06	0935-0852
LTA-750 X KING QUAD 08-18	0935-0854
TEXTRON	
WILDCAT SPORT LTD 18	0935-0852
WILDCAT TRAIL LTD 18	0935-0852
WILDCAT XX EPS 18	0935-0854
YAMAHA	
YFM400 GRIZZLY IRS 07-08	0935-0852
YFM400 KODIAK 4WD 00-06	0935-0852
450 RHINO 06-09	0935-0852
KODIAK 450 4WD 18-19	0935-0852
YFM450 GRIZZLY IRS 07-14	0935-0852
YFM450 KODIAK 03-06	0935-0852
YFM45FX WOLVERINE 450 4X4 06-10	0935-0852
YFM550 GRIZZLY 09-14	0935-0852
660 RHINO 04-07	0935-0852
YFM660 GRIZZLY 02-08	0935-0852
700 RHINO FI 08-13	0935-0852
KODIAK 700 4WD 16-18	0935-0856
KODIAK 700 4WD 19	0935-0852
VIKING 700 14-19	0935-0852
WOLVERINE 16-18	0935-0856
YFM700 GRIZZLY 07-16	0935-0852
YFM700 GRIZZLY EPS 17-18	0935-0856
YFM700 GRIZZLY EPS SE 19	0935-0852
YXZ1000R EPS 16-19	0935-0854

ENGINE



1901-0335



1901-0336



1901-0337



1901-0340



1901-0338

DEM REPLACEMENT COOLING FANS

Easily installs using original mounting hardware. All fans are waterproof and dustproof. All fans (except Polaris fans) are typically 25% higher CFM than the stock fan. CFM = cubic feet per minute; it's a rating used to tell how much airflow a fan has. The Polaris fans are OEM compatible in design and output. Less expensive than factory replacements with more performance.

FITS MODEL	PART #
DEM REPLACEMENT COOLING FANS	
ARCTIC CAT	
375 02	1901-0340
400 02-07	1901-0340
500 02-09	1901-0340
550 TRV 09	1901-0340
650 4X4 04-10	1901-0340
700 06-10	1901-0340
PROWLER 1000 09	1901-0340
PROWLER 550 09	1901-0340
PROWLER 650 06-09	1901-0340
PROWLER 700 08-09	1901-0340
THUNDERCAT 4X4 08-10	1901-0340
1000 TRV 09-10	1901-0340
CAN-AM	
OUTLANDER 400 08	1901-0336
OUTLANDER 500 07-08	1901-0336
OUTLANDER 650 06-08	1901-0336
OUTLANDER 800 06-08	1901-0336
RENEGADE 500 08	1901-0336
RENEGADE 800 07-08	1901-0336
POLARIS	
SPORTSMAN 400 04 MODEL CODE - A04CH42AA/AE/AG, 23 CM (9")	1901-0336
SPORTSMAN 500 04 MODEL CODE - A04CH50AA/AG/AE/AG, 23 CM (9")	1901-0336
SPORTSMAN 500 04 MODEL CODE - A04CH50AQ/AQ/AR/AS/AT/AV/AW/AX, 28 CM (11")	1901-0334
SPORTSMAN 400 04 MODEL CODE - A04CH42AQ/AR/AS/AT/AV, 28 CM (11")	1901-0334
ATP 330 4X4 04	1901-0339
ATP 500 4X4 04-05	1901-0336
ATV PRO 500 4X4 PPS 02	1901-0336
BIG BOSS 6X6 00-02	1901-0336
DIESEL 00-01	1901-0336
LUH 6X6 PPS 02	1901-0336
MAGNUM 325 2X4 00-02	1901-0339
MAGNUM 325 4X4 00-02	1901-0339
MAGNUM 330 2X4 03-04	1901-0339
MAGNUM 330 4X4 03-04	1901-0339
MAGNUM 500 00-03	1901-0336
PTV 4X4 SERIES 10 03	1901-0336
PTV 6X6 SERIES 10 03	1901-0336
RANGER 2X4 & 4X4 04-05	1901-0335
RANGER 500 2X4 06-09	1901-0335
RANGER 500 4X4 06-09	1901-0335
RANGER 6X6 04-05	1901-0335
RANGER 700 4X4 07-09	1901-0338
RANGER 700 4X4 CREW 08-09	1901-0338
RANGER 700 6X6 06-09	1901-0338
RANGER XP 05	1901-0338
RANGER XP 700 4X4 06	1901-0338

FITS MODEL	PART #
DEM REPLACEMENT COOLING FANS (CON'T)	
POLARIS (CON'T)	
SPORTSMAN 335 99-00	1901-0339
SPORTSMAN 335 00	1901-0339
SPORTSMAN 400 01-03	1901-0336
SPORTSMAN 400 05	1901-0334
SPORTSMAN 450 06-07	1901-0334
SPORTSMAN 500 00-03	1901-0336
SPORTSMAN 500 05-10	1901-0334
SPORTSMAN 600 03-05	1901-0337
SPORTSMAN 6X6 00-03	1901-0336
SPORTSMAN 700 02-06	1901-0337
SPORTSMAN 800 05-06	1901-0338
SPORTSMAN 800 08-10	1901-0337
SPORTSMAN 800 EFI 6X6 09-10	1901-0337
SPORTSMAN MV7 05	1901-0337
SPORTSMAN TOURING 500 EFI 08-09	1901-0334
SPORTSMAN X2 500 06-09	1901-0334
TRAIL BLAZER 400 03	1901-0336
TRAIL BOSS 00-02	1901-0339
TRAIL BOSS 325 01	1901-0339
TRAIL BOSS 330 03-04	1901-0339
WORKER 335 99	1901-0339
WORKER 500 01	1901-0336
XPEDITION 325 01-02	1901-0339
XPEDITION 425 00-02	1901-0336
XPLORER 400 01-02	1901-0336
SPORTSMAN 400 HO 4X4 11	1901-0334
SPORTSMAN 500 11	1901-0334
SPORTSMAN XP 850 09	1901-0350
SPORTSMAN XP EPS 850 09	1901-0350
SPORTSMAN XP 850 10	1901-0350
SPORTSMAN XP EPS 850 10	1901-0350
RZR XP 900 11	1901-0350
SPORTSMAN TOURING 800 09 IF BUILT 02/03/09 TO 04/06/2009	1901-0337
SPORTSMAN X2 800 09 IF BUILT 02/03/09 TO 04/06/2009	1901-0337
SPORTSMAN 700 07 IF BUILT AFTER 10/05/06	1901-0337
SPORTSMAN 800 07 IF BUILT AFTER 10/05/06	1901-0337
SPORTSMAN 700 07 IF BUILT BEFORE 10/05/06	1901-0338
SPORTSMAN 800 07 IF BUILT BEFORE 10/05/06	1901-0338
RANGER 800 4X4 10	1901-0337
RANGER 800 4X4 CREW 10	1901-0337
RANGER 800 6X6 10	1901-0337
ACE 14-17 ALL	1901-0597
YAMAHA	
GRIZZLY 600 98-01 (REPL. OIL COOLER FAN)	1901-0320
KODIAK 400 4WD 96-98 (REPL. OIL COOLER FAN)	1901-0320



1901-0318



1901-0321



1901-0329

HI-PERFORMANCE COOLING FANS

Easily installs using original mounting hardware. Typically higher CFM than stock. Sealed waterproof and dustproof motors. 6,000 hour brush life. CFM = cubic feet per minute; it's a rating used to tell how much airflow a fan has.

FITS MODEL	DESCRIPTION	PART #
HI-PERFORMANCE COOLING FANS		
CAN-AM		
OUTLANDER 400 03-08	440 CFM	1901-0725
OUTLANDER 400 09-15	800 CFM	1901-0726
OUTLANDER 450 15-18	1300 CFM	1901-0712
OUTLANDER 500 07-08	600 CFM	1901-0724
OUTLANDER 500 09-12	800 CFM	1901-0726
OUTLANDER 500 13-15	1300 CFM	1901-0712
RENEGADE 500 08	600 CFM	1901-0724
RENEGADE 500 09-12	800 CFM	1901-0726
RENEGADE 500 13-15	1300 CFM	1901-0712
OUTLANDER 570 15-18	1300 CFM	1901-0712
RENEGADE 570 16-18	1300 CFM	1901-0712
OUTLANDER 650 06-08	600 CFM	1901-0724
OUTLANDER 650 09-12	800 CFM	1901-0726
OUTLANDER 650 13-18	1300 CFM	1901-0712
OUTLANDER 650/800 13-16	1300 CFM	1901-0635
RENEGADE 650 16-18	1300 CFM	1901-0712
COMMANDER 800 11-18		
(MUST REUSE OE SHROUD)	1300 CFM	1901-0712
COMMANDER 800 11-18		
(WITH SHROUD)	1300 CFM	1901-0713
DEFENDER 800 16-18		
(MUST REUSE OE SHROUD)	1300 CFM	1901-0714
OUTLANDER 800 06-08	600 CFM	1901-0724
OUTLANDER 800 09-12	800 CFM	1901-0726
OUTLANDER 800 13-14	1300 CFM	1901-0712
RENEGADE 800 07-08	600 CFM	1901-0724
RENEGADE 800 09-11	800 CFM	1901-0726
RENEGADE 800 12-15	1300 CFM	1901-0712
OUTLANDER 850 15-18	1300 CFM	1901-0712
RENEGADE 850 16-18	1300 CFM	1901-0712

FITS MODEL	DESCRIPTION	PART #
HI-PERFORMANCE COOLING FANS (CON'T)		
CAN-AM (CON'T)		
COMMANDER 1000 11-18		
(MUST REUSE OE SHROUD)	1300 CFM	1901-0712
COMMANDER 1000 11-18		
(WITH SHROUD)	1300 CFM	1901-0713
DEFENDER 1000 16-18		
(MUST REUSE OE SHROUD)	1300 CFM	1901-0714
MAVERICK 1000 13-18		
(MUST REUSE OE SHROUD)	1300 CFM	1901-0712
MAVERICK 1000 X3 17-18		
(MUST REUSE OE SHROUD)	1300 CFM	1901-0714
MAVERICK TRAIL 1000 18		
(MUST REUSE OE SHROUD)	1300 CFM	1901-0712
OUTLANDER 1000 12-18	1300 CFM	1901-0712
OUTLANDER 1000 XMR 13-18	1300 CFM	1901-0723
RENEGADE 1000 12-18	1300 CFM	1901-0712
HONDA		
PIONEER 500 15-18	600 CFM	1901-0628
PIONEER 700 14-18		
(MUST REUSE OE SHROUD)	600 CFM	1901-0708
PIONEER 1000 16-18	600 CFM	1901-0734
KAWASAKI		
BRUTE FORCE 300 12-18	320 CFM	1901-0729
PRAIRIE 360 03-12	330 CFM	1901-0731
KVF400 PRAIRIE 97-02	330 CFM	1901-0332
KFX400 03-06	440 CFM	1901-0327
KFX700 04-09	440 CFM	1901-0326
KFX450R 08-14	330 CFM	1901-0730
KLF400 BAYOU 93-99	440 CFM	1901-0328
KVF650 BRUTE FORCE 05-09	440 CFM	1901-0330
BRUTE FORCE 650 4X4 06-13	600 CFM	1901-0728
KVF700 PRAIRIE 04-06	440 CFM	1901-0330
KVF750 BRUTE FORCE 05-11	440 CFM	1901-0329
TERYX 750 08-09	600 CFM	1901-0331
TERYX 750 10-13	1100 CFM	1901-0715
BRUTE FORCE 750 4X4 12-18	600 CFM	1901-0727
TERYX TERYX4 14-18	800 CFM	1901-0718
MULE 2500 93-00	440 CFM	1901-0717
MULE 3000, 3010, 3020 4X4		
GAS AND DIESEL	600 CFM	1901-0322
MULE 3010/4010 DIESEL 07-13	1300 CFM	1901-0719
MULE 4000 09-18	440 CFM	1901-0716
MULE PRO FXT 15-18	800 CFM	1901-0718
POLARIS		
TRAIL BLAZER 250 96-97	440 CFM	1901-0325
XPRESS 300 96	440 CFM	1901-0325
350L 2X4, 4X4, 6X6 93	440 CFM	1901-0325
TRAIL BOSS 350L 90-92	440 CFM	1901-0325
400L 2X4 94-95	440 CFM	1901-0325
400L 4X4 94	440 CFM	1901-0325
400L 6X6 94	440 CFM	1901-0325
400L 6X6 96	440 CFM	1901-0325
BIG BOSS 6X6 400L 95	440 CFM	1901-0325
BIG BOSS 6X6 400L 97	440 CFM	1901-0325
SPORTSMAN 400L 97	440 CFM	1901-0325
XPLORER 400 99-00	440 CFM	1901-0325
XPLORER 400L 96-98	440 CFM	1901-0325
XPLORER 400 4X4 02	440 CFM	1901-0325
RANGER 800 XP 12	1340 CFM	1901-0413
MAGNUM 425 2X4 95-98	440 CFM	1901-0325
MAGNUM 425 4X4 95-98	440 CFM	1901-0325
BIG BOSS 500 6X6 98-99	440 CFM	1901-0325
DIESEL 99	440 CFM	1901-0325
MAGNUM 500 99	440 CFM	1901-0325
MAGNUM 500 6X6 96-97	440 CFM	1901-0325
SPORTSMAN 500 4X4 93-96	440 CFM	1901-0325
SPORTSMAN 500 96-99	440 CFM	1901-0325
WORKER 500 99	440 CFM	1901-0325
XPLORER 500 95	440 CFM	1901-0325
XPLORER 500 00-01	440 CFM	1901-0325
XPLORER 500 97	440 CFM	1901-0325
SPORTSMAN 550 11-14	1300 CFM	1901-0722
RANGER 570 16-18	950 CFM	1901-0700
RANGER 570 FULL SIZE		
(MUST REUSE OE SHROUD) 15-16	1630 CFM	1901-0710
RANGER 570 MID SIZE		
(MUST REUSE OE SHROUD) 16-18	950 CFM	1901-0711

FITS MODEL	DESCRIPTION	PART #
HI-PERFORMANCE COOLING FANS (CON'T)		
POLARIS (CON'T)		
RANGER 800 4X4 11	1340 CFM	1901-0413
XPRESS 400 96-97	440 CFM	1901-0325
RANGER 800 4X4		
DIESEL CREW 12	1340 CFM	1901-0413
RANGER 800 6X6 12	1340 CFM	1901-0413
RANGER 800 EPS 12	1340 CFM	1901-0413
RANGER 800 CREW 12	1340 CFM	1901-0413
RZR 800 08-10		
MORE THAN STOCK FAN	100 CFM	1901-0337
RZR S 800 09-10		
MORE THAN STOCK FAN	100 CFM	1901-0337
RZR 800 08-10		
MORE THAN STOCK FAN	200 CFM	1901-0338
RZR S 800 09-10		
MORE THAN STOCK FAN	200 CFM	1901-0338
SCRAMBLER 850 13-18	1300 CFM	1901-0722
SPORTSMAN 850 11-18	1300 CFM	1901-0722
RANGER 900 XP		
(MUST REUSE OE SHROUD) 13-18	1630 CFM	1901-0710
RZR S-900		
(MUST REUSE OE SHROUD) 15-18	1225 CFM	1901-0709
GENERAL		
(MUST REUSE OE SHROUD) 16-18	1225 CFM	1901-0709
RANGER 1000 XP		
(MUST REUSE OE SHROUD) 17	1630 CFM	1901-0710
RZR 1000 XP		
(MUST REUSE OE SHROUD) 14-18	1225 CFM	1901-0709
RZR S-1000		
(MUST REUSE OE SHROUD) 16-18	1225 CFM	1901-0709
SCRAMBLER 1000 14-18	1630 CFM	1901-0721
SPORTSMAN 1000 15-18	1630 CFM	1901-0721
SUZUKI		
KING QUAD LT-A400 02-17	440 CFM	1901-0733
KING QUAD LT-F400 02-17	440 CFM	1901-0733
LT-A450X 07-09	440 CFM	1901-0351
LT-A450XZ 08-09	440 CFM	1901-0351
LT-A500XP 09	440 CFM	1901-0351
LT-A500XPZ 09	440 CFM	1901-0351
KING QUAD LT-A500 15-18	440 CFM	1901-0732
LT-A700X 06-07	440 CFM	1901-0351
LT-V700F TWIN PEAKS 04-05	440 CFM	1901-0330
LT-A750X 08-09	440 CFM	1901-0351
LT-A750XP 09	440 CFM	1901-0351
LT-A750XPZ 09	440 CFM	1901-0351
LT-A750XZ 08-09	440 CFM	1901-0351
KING QUAD LT-A750 14-18	440 CFM	1901-0732
YAMAHA		
GRIZZLY 400 07-08	440 CFM	1901-0319
KODIAK 400 2WD 00-01	440 CFM	1901-0315
KODIAK 400 2WD 04	440 CFM	1901-0319
KODIAK 400 4WD 00-02	440 CFM	1901-0315
KODIAK 400 4WD 03-06	440 CFM	1901-0319
GRIZZLY 450 07-09	440 CFM	1901-0319
KODIAK 450 4WD 03-06	440 CFM	1901-0319
WOLVERINE 450 06-09	440 CFM	1901-0319
RHINO 450 04-09	800 CFM/SINGLE FAN	1901-0312
GRIZZLY 550 09	440 CFM	1901-0318
GRIZZLY 660 02-08	440 CFM	1901-0316
RHINO 660 04-07	800 CFM/SINGLE FAN	1901-0312
GRIZZLY 700 07-10	440 CFM	1901-0318
GRIZZLY/KODIAK 700 15-18	750 CFM	1901-0694
RHINO 700 08-09	800 CFM	1901-0321
VIKING 700 ALL	800 CFM	1901-0599
WOLVERINE & X4 16-18	800 CFM	1901-0706
YXZ 1000 16-18	800 CFM	1901-0707
YXZ1000 16-18		
(RECOMMENDED FOR TURBOS)	1300 CFM	1901-0627 ¹

¹ MAY REQUIRE 15 AMP CIRCUIT BREAKER

PLOWES
WINCHES
UTV
RACKS
IMPLEMENTES & TOWING
LUGGAGE
BODY
CONTROLS
ELECTRICAL
WHEELS & TIRES
SUSPENSION & DRIVE
BRAKING
ENGINE
RIDER
GARAGE
PROMO



POWER COMMANDER III USB

USB port provides an instant, problem-free way to connect your Power Commander to a computer. Provides precise information for fine tuning a fuel injected ATV when changing an air filter, installing a new exhaust system or doing additional engine performance modifications. Includes a built in microprocessor and a specific map designed to improve engine performance over stock; Dynojet continuously maps new calibrations for downloading on their website (www.powercommander.com). If you do not have a computer you can change the settings with three touch buttons on the faceplate. OEM style wiring connectors with improved harness protection are supplied. Easy to follow instructions included. Software is compatible with Windows 98se/ME/2000/XP; opens all maps with .djm extension. USB special cable and 9V battery power adapter are included. Made in the USA.



POWER VISION 3

Flash performance tunes via OEM diagnostic connector, no need to remove and send out ECU. Display vehicle data channels in real-time. Weather resistant for use in all conditions. High contrast display, viewable in direct sunlight. Fueling revised for maximum power and torque. Spark timing optimized for 91-93 octane fuel. Rev limit raised.



POWER COMMANDER FC

Uses OEM style connectors and high quality wiring harnesses. Small, lightweight and easy to fit on the ATV. Pre-programmed with maps specific to make and model. No computer necessary for modifying fuel management. Fully adjustable computer compatibility for ultimate tuning and personalization. Software is compatible with Power Commander, so you can download Power Commander maps to the unit. Integrated O2 optimizer where applicable. Made in the USA.



POWER COMMANDER V

Less than half the size of the PCIII USB. USB powered from computer (9-volt adapter no longer needed for programming). Two-position map switching function built in (map switch not included). Gear/speed input allows for map adjustment based on gear and speed. Analog input allows user to install any 0-5V sensor and build an adjustment table based on its input such as boost or temperature. With gear-position connected, the PCV is capable of allowing each cylinder to be mapped individually and for each gear. Unit has a -100/+250% fuel change range (up from -100/+200%), which allows more adjustment. Ten throttle position columns (up from nine on PCIII USB). Enhanced "accel pump" utility (increased adjustment and sensitivity ranges). Made in the USA.



POWER VISION CX

Performance tuner and data monitor that offers the latest flash tuning technology, realtime data monitoring, and other industry-exclusive features. Developed to tune most modern Polaris off-road vehicles with the Bosch ME17 ECU. Tunes via OEM diagnostic connector; no need to remove and send out ECU. Display vehicle data channels in real-time. Weather-resistant for use in all conditions. High-contrast display; viewable in direct sunlight. The Power Vision CX product Suite includes a handheld flash device, vehicle interface cable, and Power Core (Windows PC based tuning and datalogging application). Fueling revised for maximum power and torque. Spark timing optimized for 91-93 octane fuel. Rev limit raised in high and low gears. Speed limit raised in high and low gears. Torque limiting functions reduced or eliminated. Revised drive-by-wire throttle profiles for high and low gears. Lower fan turn-on temps. Left foot brake mode enabled. Retains ADC and Turf mode where applicable. C3 tuning software included; gives end users complete control of their calibration. Start with the original calibration, or modify/edit existing calibrations. Manage and send tune files to the Power Vision CX. Real-time cell tracing. Monitor and log supported data channels from the ECU. Tune lock option to protect unauthorized sharing. Winpeg 8 data center used to review datalogs generated from C3 in three different views (graph trace, table, or 3D). Synchronized datalog-to-calibration item referenced for precision tuning. Export graphs or .csv files. Made in the USA.

MODEL	PCIII USB	PCFC	PVCX	PV3	PCV	PCV*
ARCTIC CAT						
450/500 MODELS 13	-	1020-2204	-	-	-	-
550H1 09-14	-	1020-2205	-	-	-	-
550 MODELS 15-16	-	-	-	-	-	1020-2640
PROWLER 700 08	1020-0638	-	-	-	-	-
700 H1 09-12	-	-	-	-	1020-1037	-
700 MODELS 15-16	-	-	-	-	-	1020-2640
WILDCAT TRAIL 14-17	-	-	-	-	1020-2274	-
THUNDERCAT	-	1020-2208	-	-	-	-
1000/XT 08-13	-	-	-	-	-	-
1000 TRV 09	-	1020-2208	-	-	1020-1163	1020-1773
1000 TRV/MUDPRO 10-14	-	-	-	-	1020-2077	-
PROWLER 1000 08-13	-	-	-	-	1020-1038	-
WILDCAT 1000 12-14	-	1020-2211	-	-	1020-1774	-
CAN AM						
DS450 08-15	-	1020-2212	-	-	1020-1129	-
MAVERICK 13-17	-	1020-2275	-	-	-	1020-2074
MAVERICK 15-18	-	-	-	1020-3139	-	-
MAVERICK X3 17-18	-	-	-	-	1020-2755	-
MAVERICK X3 17-19	-	-	-	1020-3138	-	-
MAVERICK TRAIL 18-19	-	-	-	1020-3140	-	-
MAVERICK TURBO 15-17	-	-	-	1020-3139	-	-
MAVERICK SPORT 19	-	-	-	1020-3140	-	-
OUTLANDER 400 09-14	-	1020-2212	-	-	-	-

MODEL	PCIII USB	PCFC	PVCX	PV3	PCV	PCV*
CAN AM (CON'T)						
OUTLANDER 450 14-17	-	1020-2214	-	-	1020-2398	-
OUTLANDER/RENEGADE 500 13-15	-	1020-2214	-	-	-	1020-2641
OUTLANDER/RENEGADE 570 16-17	-	1020-2214	-	-	-	1020-2641
OUTLANDER/RENEGADE 650 06-17	-	1020-2214	-	-	-	1020-2641
OUTLANDER/RENEGADE 800 06-11	1020-0269	-	-	-	1020-1164	-
OUTLANDER/RENEGADE 800 12-15	-	1020-2214	-	-	1020-1630	1020-2641
COMMANDER 800 11-15	-	1020-2216	-	-	-	1020-1725
COMMANDER 800/1000 16-19	-	-	-	1020-3141	-	-
OUTLANDER/RENEGADE 850 16-17	-	-	-	-	-	1020-2642
OUTLANDER/RENEGADE 1000 12-15	-	1020-2214	-	-	1020-1630	-
COMMANDER 1000 11-15	-	1020-2216	-	-	-	1020-1547
OUTLANDER/RENEGADE 1000 12-15	-	-	-	-	-	1020-2641
OUTLANDER/RENEGADE 1000 16-17	-	-	-	-	-	1020-2642
DEFENDER HD8/HD10 18-19	-	-	-	1020-3142	-	-

MODEL	PCIII USB	PCFC	PVCX	PV3	PCV	PCV*
CF MOTO						
800 EX 14-15	-	-	-	-	1020-2797	-
HONDA						
RANCHER 07-08	1020-0354	-	-	-	-	-
RANCHER 420 09-13	-	-	-	-	1020-1165	-
RANCHER 420 14-17	-	1020-2370	-	-	-	-
FOREMAN 12-13	-	1020-2218	-	-	-	1020-1697
FOREMAN 14-18	-	1020-2370	-	-	-	1020-2358
RINCON 06-14	-	1020-2218	-	-	1020-1166	-
BIG RED 09-13	-	-	-	-	-	1020-1775
PIONEER 700 14	-	-	-	-	-	1020-2326
PIONEER 700 15-18	-	-	-	-	-	1020-2756
TRX700XX 08-09	-	-	-	-	1020-0971	-
KAWASAKI						
KFX450 08-14	-	1020-2222	-	-	1020-0908	1020-1776
BRUTE FORCE 750 08-11	-	-	-	-	-	1020-1777
BRUTE FORCE 750 12-14	-	1020-2224	-	-	-	1020-1709
TERYX 09-13	-	1020-2225	-	-	1020-1008	1020-1708
TERYX 4 12-13	-	1020-2225	-	-	-	1020-2006
TERYX MODELS 14-18	-	1020-2226	-	-	-	1020-2127
KYMCO						
UXV450 16	-	-	-	-	-	1020-2810
UXV700 14-16	-	-	-	-	-	1020-2811
POLARIS						
SPORTSMAN ETX 15	-	-	-	-	-	1020-2399
SPORTSMAN 450 16	-	-	-	-	-	1020-2539
SPORTSMAN 450/ 570/850/1000 -17-19	-	-	-	1020-3154	-	-
RANGER 150/ RANGER 500/ RANGER 570 17-19	-	-	-	1020-3157	-	-
RANGER 500 17	-	-	1020-2764	-	-	-
SPORTSMAN 550 09-14	-	1020-2227	-	-	-	-
RANGER 570 14	-	1020-2228	-	-	-	1020-2278
RZR 570 12-16	-	1020-2228	-	-	-	-
RZR 570 17	-	-	-	-	-	1020-2763
RANGER XP 06-08	1020-0328	-	-	-	-	-
RANGER 800 11-14	-	1020-2230	1020-2695	-	-	1020-2279
RZR 800/S 08-10	-	1020-2229	-	-	-	1020-1574
RZR 800/S/4 11-14	-	1020-2230	1020-2695	-	-	1020-1536
SPORTSMAN 800 05-14	-	1020-2231	-	-	1020-1251	-
SPORTSMAN 850 09-11	-	-	-	-	1020-1130	1020-1575
SPORTSMAN 850 12	-	-	-	-	-	1020-1698
SPORTSMAN 850 13-17	-	1020-2234	-	-	-	1020-2044
SCRAMBLER 850 13-17	-	1020-2234	-	-	-	1020-2044

MODEL	PCIII USB	PCFC	PVCX	PV3	PCV	PCV*
POLARIS (CON'T)						
SCRAMBLER 850 / 1000 17-19	-	-	-	1020-3154	-	-
ACE 900 16-17	-	-	-	-	-	1020-2541
RANGER XP900 13-15	-	1020-2235	1020-2699	-	-	-
RANGER XP900 16-17	-	-	1020-2699	-	-	1020-2540
RANGER XP1000 17-19	-	-	-	1020-3152	-	-
RZR 900 15-17	-	-	-	-	-	1020-2401
RZR 900 / S / 4 15-19	-	-	-	1020-3148	-	-
RZR XP900 11	-	1020-2236	1020-2696	-	-	1020-1625
RZR XP900 12-14	-	1020-2236	1020-2696	-	-	1020-1695
RZR S 1000 2016-2019	-	-	-	1020-3153	-	-
GENERAL 1000 16-17	-	-	1020-2700	-	-	-
GENERAL 1000 / 4 16-19	-	-	-	1020-3151	-	-
RANGER XP1000 17	-	-	-	-	-	1020-2808
RZR 1000 S 16-17	-	-	-	-	-	1020-2424
XP1000 / 4 14-19	-	-	-	1020-3149	-	-
XP TURBO 16-19	-	-	-	1020-3038	-	-
RSI 18-19	-	-	-	1020-3158	-	-
RZR XP1000 14	-	1020-2237	-	-	-	1020-2138
RZR XP1000 15-17	-	-	-	-	-	1020-2424
RZR XP TURBO 16-17	-	-	-	-	-	1020-2550
SCRAMBLER XP1000 14-16	-	1020-2234	-	-	-	1020-2280
SPORTSMAN XP1000 15-16	-	1020-2234	-	-	-	1020-2044
SPORTSMAN XP1000 17	-	-	-	-	-	1020-2759
SUZUKI						
KINGQUAD 400 11-17	-	-	-	-	-	1020-1474
LTZ400 09-12	-	-	-	-	1020-1034	-
LTR450 06-10	-	1020-2240	-	-	1020-0972	-
KINGQUAD 500 11-17	-	-	-	-	1020-1475	-
YAMAHA						
YZF450 R / X 09-17	-	1020-2246	-	-	1020-0909	1020-1781
GRIZZLY 550 09-14	-	1020-2250	-	-	1020-1168	-
GRIZZLY 700 07-13	-	1020-2250	-	-	1020-1010	-
GRIZZLY 700 14-17	-	1020-2250	-	-	-	1020-2282
KODIAK 700 16-17	-	-	-	-	-	1020-2809
RAPTOR 700 06-14	-	1020-2249	-	-	1020-0973	1020-1783
RAPTOR 700 15-17	-	1020-2249	-	-	-	1020-2481
RHINO 700 08-13	-	-	-	-	1020-0907	1020-1745
VIKING 14-17	-	1020-2251	-	-	-	1020-2137
WOLVERINE 16-17	-	-	-	-	-	1020-2479
YZX 1000 16-17	-	-	-	-	1020-2542	-

* CONTROLS BOTH IGNITION & FUEL

POWER MODULE

Waterproof plug and play device. Bypasses restrictions placed on power output at low speeds. Uses OEM style connectors. No cutting or soldering needed. Removing the Power Module returns the vehicle to stock configuration; no permanent changes are made. Made in the USA.



DESCRIPTION	PART #
POWER MODULE	
ARCTIC CAT	
650 V-TWIN AUTO 04-06	2101-0064
KAWASAKI	
KVF650 BRUTE FORCE 05-09	2101-0064
KVF650I BRUTE FORCE 06-09	2101-0064
KVF650 PRAIRIE 02-03	2101-0064

DESCRIPTION	PART #
POWER MODULE	
KAWASAKI (CON'T)	
KVF700 PRAIRIE 04-06	2101-0064
KVF750I BRUTE FORCE 02-07	2101-0064
SUZUKI	
LT700 TWIN PEAKS 04-05	2101-0064

PLOWS
WINCHES
UTV
RACKS
IMPLEMENT & TOWING
LUGGAGE
BODY
CONTROLS
ELECTRICAL
WHEELS & TIRES
SUSPENSION & DRIVE
BRAKING
ENGINE
RIDER
GARAGE
PROMO

ENGINE

CARB REPAIR KITS

Complete kit to rebuild OEM carburetors.



FITS MODEL	PART #
CARB REPAIR KITS	
ARCTIC CAT	
50 2X4 08	1003-0685
50 Y-6 06	1003-0684
90 2-STROKE 02-04	1003-1759
90 4-STROKE 04-05	1003-1758
90 UTILITY 2X4 06-13	1003-0682
250 2X4 99-01	1003-1770
250 2X4 02-05	1003-0551
250 2X4 06-07	1003-0550
250 2X4 08-09	1003-0549
250 4X4 01	1003-1770
250 4X4 02-05	1003-0551
300 2X4 98-00	1003-0548
300 2X4 01-04	1003-0545
300 2X4 10-16	1003-0546
300 4X4 98-00	1003-0548
300 4X4 01-05	1003-0545
350 CR 12	1003-0541
350 UTILITY 4X4 11	1003-0541
366 FIS W/AT 08	1003-1756
366 FIS W/AT 09-10	1003-1755
366 SE FIS W/AT 11	1003-1755
375 2X4 W/AT 02	1003-0543
375 4X4 W/AT 02	1003-0543
400 2X4 98	1003-0683
400 2X4 99-01	1003-0547
400 4X4 98-00	1003-0547
400 4X4 14-15	1003-0541
400 4X4 W/AT 03-04	1003-0539
400 4X4 W/MT 01	1003-0547
400 4X4 W/MT 02	1003-0540
400 4X4 W/MT 03-04	1003-0539
400 FIS 2X4 W/AT 03	1003-0539
400 FIS 2X4 W/AT 04	1003-0536
400 FIS 2X4 W/MT 03	1003-0539
400 FIS 2X4 W/MT 04	1003-0536
400 FIS 4X4 TRV 06-14	1003-1754
400 FIS 4X4 W/AT 03	1003-0539
400 FIS 4X4 W/AT 04-05	1003-0536
400 FIS 4X4 W/AT 06-07	1003-0537
400 FIS 4X4 W/AT 08	1003-0538
400 FIS 4X4 W/AT 13-14	1003-0541
400 FIS 4X4 W/AT LTD 07	1003-0537
400 FIS 4X4 W/MT 02	1003-0540
400 FIS 4X4 W/MT 03	1003-0539
400 FIS 4X4 W/MT 04-05	1003-0536
400 FIS 4X4 W/MT 06-07	1003-0537
400 FIS 4X4 W/MT 08	1003-0538
400 TBX 4X4 04-05	1003-0536
400 TBX 4X4 06	1003-0537
400 VP 4X4 W/AT / W/MT 05-06	1003-0536
ALTERRA 400 16-17	1003-0541
454 2X4 97-98	1003-0681
454 4X4 96-98	1003-0681
500 4X4 98-99	1003-0681
500 4X4 W/AT 00-02	1003-0535
500 4X4 W/MT 01	1003-0535
500 FIS 4X4 W/AT 02	1003-0535
500 FIS 4X4 W/AT 03	1003-0534
500 FIS 4X4 W/AT 04	1003-0533
500 FIS 4X4 W/AT 05-07	1003-0531
500 FIS 4X4 W/AT 08-09	1003-0532
500 FIS 4X4 W/MT 02	1003-0535
500 FIS 4X4 W/MT 03	1003-0534
500 FIS 4X4 W/MT 04	1003-0533
500 FIS 4X4 W/MT 05-07	1003-0531
500 FIS 4X4 W/MT 08-09	1003-0532
500 FIS TBX 4X4 03	1003-0534
500 FIS TBX 4X4 04	1003-0533
500 FIS TBX 4X4 05-06	1003-0531
500 FIS TBX 4X4 02	1003-0535
500 FIS TRV 4X4 03	1003-0534

FITS MODEL	PART #
CARB REPAIR KITS (CON'T)	
ARCTIC CAT (CON'T)	
500 FIS TRV 4X4 04-05	1003-1753
500 FIS TRV 4X4 06	1003-0531
500 FIS TRV 4X4 07-08	1003-0532
650 4X4 HI 07	1003-0529
650 4X4 HI 08-09	1003-0528
650 4X4 HI 10-11	1003-0527
650 4X4 W/AT V2 04-06	1003-0530
650 HI LTD 05-06	1003-1752
650 HI LTD 07	1003-0529
650 HI MUDPRO 10-11	1003-0528
650 HI TBX 07-09	1003-0529
650 TRV 07	1003-0529
650 TRV 08	1003-0528
650 TRV LTD 07	1003-0529
650I 4X4 12	1003-0527
PROWLER 650 07	1003-0529
PROWLER 650 XT 06-07	1003-0529
CAN-AM	
RALLY 175 03-07	1003-0524
OUTLANDER 330 04-05	1003-0526
OUTLANDER 330 4X4 05	1003-0526
OUTLANDER 400 03-04	1003-0525
OUTLANDER 400 STD 2X4 05	1003-0525
OUTLANDER 400 STD 4X4 05-08	1003-0525
OUTLANDER 400 XT 4X4 04-08	1003-0525
OUTLANDER MAX 400 STD 4X4 05-08	1003-0525
OUTLANDER MAX 400 XT 4X4 06-08	1003-0525
HONDA	
TRX70 86-87	1003-1781
TRX90 93-98	1003-0544
TRX90 99-05	1003-0567
TRX90 06-12	1003-0566
TRX90 13-19	1003-0565
ATC200 83	1003-0612
ATC200E 82-83	1003-0612
ATC200ES 84	1003-0612
ATC200M 84-85	1003-0612
ATC200S 84-86	1003-0613
ATC200X 83-85	1003-0614
ATC200X 86-87	1003-0615
TRX200 90-91	1003-0694
TRX200D 90-91	1003-0694
TRX200SX 86-88	1003-1774
ATC250ES 85	1003-0616
ATC250ES 86-87	1003-0617
ATC250SX 85	1003-0618
ATC250SX 86-87	1003-0617
TRX250 FOURTRAX 85	1003-0646
TRX250 FOURTRAX 86-87	1003-0679
TRX250 RECON 97-98	1003-0620
TRX250 RECON 99-01	1003-0624
TRX250TE RECON 02-04	1003-0624
TRX250TE RECON 05-14	1003-0621
TRX250TM RECON 02-04	1003-0624
TRX250TM RECON 05-14	1003-0621
TRX300 FOURTRAX 88-90	1003-0626
TRX300 FOURTRAX 91-00	1003-0652
TRX300FW FOURTRAX 4X4 88-90	1003-0626
TRX300FW FOURTRAX 4X4 91-00	1003-0652
TRX350 86-87	1003-0573
TRX350D 87-89	1003-0573
TRX350FE 00-03	1003-0569
TRX350FE 04-06	1003-0568
TRX350FM FOURTRAX RANCHER 00-03	1003-0569
TRX350FM FOURTRAX RANCHER 04-06	1003-0568
TRX350TE 00-03	1003-0569
TRX350TE 04-06	1003-0568
TRX350TM FOURTRAX RANCHER 00-03	1003-0569
TRX350TM FOURTRAX RANCHER 04-06	1003-0568
TRX400FA 04-07	1003-0630
TRX400FGA FOURTRAX RANCHER 4X4 04-07	1003-0630
TRX450ES / TRX450S 98-01	1003-0570
TRX450FE / TRX450FM 02-04	1003-0570
TRX500FA 01-04	1003-0571
TRX500FA 05-14	1003-0597
TRX400FW FOURTRAX FOREMAN 4X4 95-03	1003-0643

FITS MODEL	PART #
CARB REPAIR KITS (CON'T)	
HONDA (CON'T)	
TRX500FE 05-11	1003-0597
TRX500FGA 04	1003-0571
TRX500FGA 05-08	1003-0597
TRX500FM 05-11	1003-0597
TRX500FPA 09-14	1003-0597
TRX500FPE 07-11	1003-0597
TRX500FPM 08-11	1003-0597
TRX500TM 05-06	1003-0597
TRX650 RINCON 03-05	1003-0564
KAWASAKI	
KLF220 BAYOU 90-99	1003-0591
KLF220 BAYOU 00-02	1003-0592
KLF250 BAYOU 03-06	1003-0594
KLF250 BAYOU 07-11	1003-0593
KEF300 LAKOTA 95-03	1003-0585
KLF300A BAYOU 86-87	1003-1767
KLF300B BAYOU 88	1003-1767
KLF300B BAYOU 89-91	1003-0584
KLF300B BAYOU 92-95	1003-0583
KLF300B BAYOU 96-05	1003-0582
KLF300C BAYOU 4X4 89-96	1003-0581
KLF300C BAYOU 4X4 97-05	1003-0667
KVF300 BRUTE FORCE 12-18	1003-0580
KVF300A PRAIRIE 4X4 99-02	1003-0579
KVF300B PRAIRIE 2X4 99-02	1003-0579
KVF360A PRAIRIE 4X4 03-13	1003-0578
KVF360B PRAIRIE 03-11	1003-0578
KVF360C PRAIRIE 4X4 03-13	1003-0578
KLF400 BAYOU 93-95	1003-1768
KVF400C PRAIRIE 4X4 99-02	1003-0577
KVF400D PRAIRIE 99-02	1003-0577
KVF650 BRUTE FORCE 05-13	1003-0575
KVF650 I BRUTE FORCE 06-13	1003-0576
KVF650 PRAIRIE 02-03	1003-0575
KFX 700 V-FORCE 04-09	1003-0658
KVF700 PRAIRIE 04-06	1003-0662
KVF750 BRUTE FORCE 05-07	1003-0574
POLARIS	
SPORTSMAN 90 01	1003-0637
SPORTSMAN 90 02-03	1003-0522
SPORTSMAN 90 04-06	1003-0521
SPORTSMAN 90 07-16	1003-0638
RZR 170 09-14	1003-0628
PHOENIX 200 05-14	1003-0520
SAWTOOTH 200 06-07	1003-0520
BIG BOSS 250 4X6 89-92	1003-0501
BIG BOSS 250 6X6 91-93	1003-0501
TRAIL BLAZER 250 90-06	1003-0501
TRAIL BOSS 250 2X4 86-99	1003-0501
TRAIL BOSS 250 4X4 87-95	1003-0501
XPLORER 250 4X4 00-02	1003-0501
300 2X4 / 4X4 94-95	1003-0516
BIG BOSS 300 6X6 94	1003-0516
HAWKEYE 2X4 06-11	1003-0519
HAWKEYE 4X4 06-07	1003-0519
SPORTSMAN 300 4X4 08-10	1003-0519
XPLORER 300 4X4 96-99	1003-0516
XPRESS 300 96-99	1003-0516
MAGNUM 325 2X4 / 4X4 00-02	1003-0513
MAGNUM 325 4X4 HDS 02	1003-0513
MAGNUM 325 4X4 HDS AA / HDS 4X4 01	1003-0513
TRAIL BOSS 325 00-02	1003-0513
XPEDITION 325 00-02	1003-0514
ATP 330 4X4 04-05	1003-0512
MAGNUM 330 2X4 03	1003-0511
MAGNUM 330 2X4 04-05	1003-0512
MAGNUM 330 4X4 05	1003-0512
MAGNUM 330 4X4 AA AB AC 03	1003-0511
MAGNUM 330 4X4 AA AB AC 04	1003-0512
MAGNUM 330 4X4 FB 03	1003-0511
MAGNUM 330 4X4 FB 04	1003-0512
TRAIL BOSS 330 03	1003-0511
TRAIL BOSS 330 04-13	1003-0512
SPORTSMAN 335 99-00	1003-0515
WORKER 335 99	1003-0515
TRAIL BLAZER 330 08-13	1003-0512

FITS MODEL	PART #
CARB REPAIR KITS (CON'T)	
POLARIS (CON'T)	
350L 2X4 / 4X4 / 6X6 93	1003-0517
BIG BOSS 350L 6X6 93	1003-0517
SPORTSMAN 350 4X4 93	1003-0517
TRAIL BLAZER 350L 2X4 / 4X4 90-92	1003-0517
400L 2X4 94-95	1003-0507
400L 4X4 94	1003-0507
BIG BOSS 400L 6X6 94-96	1003-0507
BIG BOSS 400L 6X6 97	1003-0635
HAWKEYE 400 HO 2X4 11-14	1003-0510
MAGNUM 400L 6X6 97	1003-0634
RANGER 4X4 400 10-14	1003-0510
SPORTSMAN 400 4X4 94-96	1003-0507
SPORTSMAN 400 4X4 97	1003-0635
SPORTSMAN 400 4X4 02-05	1003-0509
SPORTSMAN 400 4X4 AA AE AG / AQ-AV 04	1003-0509
SPORTSMAN 400 HO 4X4 09-14	1003-0510
TRAIL BLAZER 400 03	1003-0635
XPLORER 400L 4X4 95-96	1003-0507
XPLORER 400L 4X4 97-00	1003-0635
XPLORER 400L 4X4 01-02	1003-1769
XPRESS 400L 2X4 96	1003-0507
XPRESS 400L 2X4 97	1003-0635
MAGNUM 425 2X4 95-96	1003-1766
MAGNUM 425 2X4 97	1003-0634
MAGNUM 425 2X4 98	1003-0639
MAGNUM 425 4X4 95-96	1003-1766
MAGNUM 425 4X4 97	1003-0634
MAGNUM 425 4X4 98	1003-0639
XPEDITION 425 00-02	1003-0640
SPORTSMAN 450 06	1003-0510
BIG BOSS 500 6X6 98-99	1003-0632
BIG BOSS 500 6X6 00-02	1003-0631
MAGNUM 500 2X4 HDS 02	1003-0641
MAGNUM 500 4X4 00-01	1003-0641
MAGNUM 500 4X4 AA / AB/FB 02	1003-0641
MAGNUM 500 4X4 HDS AA 01-02	1003-0641
MAGNUM 500 4X4 HDS FB 01	1003-0641
RANGER 2X4 500 05-09	1003-0629
RANGER 4X4 500 99	1003-0505
RANGER 4X4 500 04-06	1003-0629
RANGER 6X6 500 99	1003-0505
RANGER 6X6 500 00	1003-0633
RANGER 6X6 500 02-05	1003-0629
SPORTSMAN 500 4X4 96-98	1003-0505
SPORTSMAN 500 4X4 00	1003-0503
SPORTSMAN 500 4X4 HO 01-13	1003-0504
SPORTSMAN 500 4X4 HO AA-AC-AE-AG 04	1003-0504
SPORTSMAN 500 4X4 HO AD-AX 04	1003-0504
SPORTSMAN 500 4X4 RSE 00	1003-0503
SPORTSMAN 500 4X4 RSE 01-02	1003-0504
SPORTSMAN 500 6X6 00-08	1003-0631
SPORTSMAN FOREST 500 11-13	1003-0504
SPORTSMAN TOURING 500 10-13	1003-0504
WORKER 500 4X4 01	1003-0504
XPLORER 500 97	1003-0505
SPORTSMAN 600 4X4 03	1003-0502
SPORTSMAN 600 4X4 05	1003-0503
SPORTSMAN 700 4X4 02	1003-0503
SPORTSMAN 700 4X4 03-07	1003-0502
SPORTSMAN MV7 05	1003-0502
SUZUKI	
LT-50 84-87	1003-1765
LT-A50 02-05	1003-0678
LT-80 87-06	1003-0676
ALT-125 83-86	1003-1776
LT-125 83-87	1003-1776
LT-F160 91-01	1003-0674
LT-230E 87-88	1003-1764
LT-230E 89-93	1003-0673
LT-230G 85-86	1003-1764
LT-4WD 250 QUAD RUNNER 87-89	1003-1777
LT-4WD 250 QUAD RUNNER 90-96	1003-0671
LT-4WD 250 QUAD RUNNER 97-98	1003-1778
LT-F250 2WD 88-89	1003-1777
LT-F230 86-87	1003-1764
LT-250S 89-90	1003-0672

FITS MODEL	PART #
CARB REPAIR KITS (CON'T)	
SUZUKI (CON'T)	
LT-F250 2WD 90-99	1003-0671
LT-F250 2WD 00-01	1003-0559
LT-F250 OZARK 02-14	1003-0560
LT-F250F 4WD QUAD RUNNER 99	1003-0670
LT-F250F 4WD QUAD RUNNER 00-02	1003-0559
LT-300E 87-89	1003-1779
LT-F300F KING QUAD 99	1003-0562
LT-F300F KING QUAD 00-02	1003-0561
LT-F4WDX KING QUAD 300 91-98	1003-0562
LT-A400 2WD KING QUAD 08-09	1003-0557
LT-A400 EIGER 2WD 02-07	1003-0556
LT-A400F 4WD KING QUAD 08-10	1003-0557
LT-A400F EIGER 4WD 02-07	1003-0556
LT-F400 2WD KING QUAD 08	1003-0557
LT-F400 EIGER 2WD 02-07	1003-0556
LT-F400F 4WD KING QUAD 08-10	1003-0557
LT-F400F EIGER 4WD 02-07	1003-0556
LT-A500F QUAD MASTER AUTO 00-01	1003-0555
LT-A500F VINSON 02-05	1003-0554
LT-A500F VINSON 06-07	1003-0552
LT-F500F 98-02	1003-0553
LT-F500F VINSON 03-07	1003-0552
LTV-700F TWIN PEAKS 04-06	1003-0662
YAMAHA	
YFM80 BADGER 92-01	1003-0595
YFM80 GRIZZLY 05-08	1003-0596
YFM100 89-91	1003-0595
YFA1 89-04	1003-0655
YFM125 GRIZZLY 04-13	1003-0600
YFB250 TIMBERWOLF 92-98	1003-0603
YFB250FW TIMBERWOLF 94-00	1003-0603
YFM250 BEARTRACKER 99-04	1003-0605
YFM250 BIG BEAR 07-09	1003-0604
YFM250 MOTO-4 89-91	1003-0603
YFM250B BRUIN 05-06	1003-0602
YFM350 GRIZZLY IRS 07-11	1003-0610
YFM350 WARRIOR 87-92	1003-1780
YFM350 WARRIOR 93-04	1003-0695
YFM350BA BRUIN 2WD 04-06	1003-0610
YFM350ER MOTO-4 87	1003-0663
YFM350ER MOTO-4 88-93	1003-0607
YFM350ER MOTO-4 94-95	1003-0601
YFM350FA BRUIN 4WD 04-05	1003-0610
YFM350FA BRUIN 4WD 06	1003-0608
YFM350FGW GRIZZLY 4WD 07-14	1003-0608
YFM350FW BIG BEAR 87-96	1003-0663
YFM350FW BIG BEAR 97	1003-1761
YFM350FW BIG BEAR 98-99	1003-1760
YFM350GW GRIZZLY 2WD 07-11	1003-0608
YFM350U BIG BEAR 96-98	1003-0663
YFM350U BIG BEAR 99	1003-1760
YFM35FX WOLVERINE 96-98	1003-0666
YFM35FX WOLVERINE 99-05	1003-0563
YFM35X WOLVERINE 06-09	1003-0608
YFM400 BIG BEAR 2WD 00-04	1003-0665
YFM400 BIG BEAR 4WD 00-06	1003-0665
YFM400 BIG BEAR IRS 07-12	1003-0665
YFM400 GRIZZLY IRS 07-08	1003-0664
YFM400 KODIAK 2WD 00	1003-1762
YFM400 KODIAK 2WD 01	1003-0659
YFM400 KODIAK 2WD 03-04	1003-0657
YFM400 KODIAK 4WD 93-95	1003-0668
YFM400 KODIAK 4WD 96-98	1003-0649
YFM400 KODIAK 4WD 99	1003-0661
YFM400 KODIAK 4WD 00	1003-1762
YFM400 KODIAK 4WD 01-02	1003-0659
YFM400 KODIAK 4WD 03-06	1003-0657
450 RHINO 06-09	1003-0700
YFM450 GRIZZLY EPS 11-14	1003-0645
YFM450 GRIZZLY IRS 07-14	1003-0645
YFM450 KODIAK 03-06	1003-0645
YFM45FX WOLVERINE 450 4X4 06-10	1003-0645
YFM600 GRIZZLY 98-00	1003-0650
YFM600 GRIZZLY 01	1003-0654
660 RHINO 04-07	1003-0699
YFM660 GRIZZLY 02-08	1003-0669



JET KITS

Stage 1: Intended for ATVs with a stock engine using the stock air box, air filter and stock pipe. Stage 1 kits are fully adjustable to allow the use of a well designed aftermarket pipes and stock replacement air filters like K&N. In most cases power increases of approximately 5% throughout the entire power range can be achieved.

Stage 2: Intended for ATVs with a stock or mildly tuned engine using a well designed aftermarket pipe with a modified air box and a stock replacement air filter. Stage 2 kits are designed for applications where individual filters cannot be installed and for applications where air box modification improves the engine's performance. In most cases power increases of approximately 8% can be achieved.

FITS MODEL	PART #
JET KITS	
ARCTIC CAT	
400 2X4 & 4X4 AUTO TRANS 03-09	1 MQ622
400 2X4 & 4X4 STANDARD 03-07	1 MQ623
500 4X4 STANDARD 03-09	1 1007-0072
650 V-2 4X4 AUTO TRANS 04-05	1 1007-0133
HONDA	
TRX250 RECON 97-16	1 MQ105
TRX300FW 92-02	1 MQ103
TRX350 RANCHER 00-06	1 MQ108
TRX400 FW FOREMAN 96-03	1 MQ104
TRX400 RANCHER 04-06	1 1007-0073
TRX450 FW FOREMAN 98-04	1 MQ106
TRX500 FOREMAN/4X4/ES 05-11	1 1007-0122
TRX650 RINCON 03-05	1 MQ112
KAWASAKI	
BRUTE FORCE 300 12-16	1 1007-0381
KVF300 PRAIRIE 99-02	1 MQ208
KVF360 PRAIRIE 02-13	1 MQ211
PRAIRIE 650 02	1 MQ210
PRAIRIE 650 03	1 1007-0074
KVF650 BRUTE FORCE 05-13	1 1007-0132
KVF650I BRUTE FORCE 06-13	1 1007-0217
PRAIRIE 700 04-06	1 1007-0075
KFX700 V-FORCE 03-09	1 MQ214
KVF750 BRUTE FORCE 05-07	1 1007-0098
TERYX 750 4X4 LE 08	1 1007-0298
POLARIS	
170 RZR 10-14	1 1007-0395
200 PHOENIX 07-16	1 1007-0277
330 TRAIL BLAZER 08-09	1 1007-0303
400 SPORTSMAN HO 08-14	1 1007-0321
SUZUKI	
OZARK 250 02-14	2 MQ313
KINGQUAD 400 STANDARD 08-10	1 1007-0355
EIGER 400 2X4 & 4X4 02-07	1 MQ310
VINSON 500 4X4 02-07	1 MQ311
YAMAHA	
250 BIG BEAR 07-09	1 1007-0279
300 GRIZZLY 12-13	1 1007-0382
YFM350 FW WOLVERINE 96-05	1 MQ403
YFM350FW BIG BEAR 87-97	1 MQ404
YFM350 WARRIOR 93-04	1,2 MQ406
350 BRUIN AUTO 2X4 & 4X4 04-06	1 1007-0124
350 GRIZZLY AUTO 2X4 & 4X4 07-11	1 1007-0280
400 BIG BEAR IRS 07-12	1 1007-0289
450 WOLVERINE 4X4 06-10	1 1007-0306
YXR450 RHINO 06-09	1 1007-0307
YFM600 GRIZZLY 98-01	1 MQ407
YFM660 GRIZZLY 02-08	1 MQ415
YXR660 RHINO 04-07	1 1007-0119

TRIPLE LAYER AIR FILTERS (DRY AND PRE OILED)

Unique triple stage foam filter designed for the most extreme conditions. Eliminates the need for power robbing dust covers and outerwear covers. Increased protection against silt, water, and sand. Allows for extended filter service intervals. Can be cleaned, re-oiled, and re-used like a 2-stage filter. Available in standard and pre-oiled. Used by factory off-road teams around the world. Made in the USA.



FITS MODEL	DRY PART #	PRE-OILED PART #
TRIPLE LAYER AIR FILTERS		
HONDA		
TRX250D RECON 97-13	1011-2566	-
TRX300 90-01	1011-2564	1011-2598
TRX300FW 92-01	1011-2564	1011-2598
TRX350 RANCHER ALL 00-06	1011-2562	1011-2596
RANCHER AT400 04-07	1011-2562	1011-2596
TRX400 4X4 FOREMAN 95-04	1011-2564	1011-2598
TRX450 FOREMAN ALL 98-06	1011-2562	1011-2596
TRX500 RUBICON/FOREMAN 01-17	1011-2563	1011-2597
TRX650/680 RINCON 03-16	1011-2563	1011-2597
BIG RED 700 09-13	1011-2563	1011-2597
KAWASAKI		
KVF650 PRAIRIE 03-06	1011-2573	1011-2602
KVF650 BRUTE FORCE 05-13	1011-2573	1011-2602
KVF650 I BRUTE FORCE 05-13	1011-2572	-
KFX700 V-FORCE 04-09	1011-2573	1011-2602
KVF700 PRAIRIE 04-09	1011-2573	1011-2602
KVF750 BRUTE FORCE 05-17	1011-2572	-
SUZUKI		
LTF250 OZARK 03-12	1011-2584	-
LTF250 88-02	1011-2586	1011-2610
LTF300 KINGQUAD 99-03	1011-2586	1011-2610
LTF 4WDX KINGQUAD 91-03	1011-2586	1011-2610
LTF 4WD QUADRUNNER 87-03	1011-2586	1011-2610
LTV700 TWIN PEAK 04-06	1011-2573	1011-2602
POLARIS		
PHOENIX 200 06-16	1011-2579	1011-2608
HAWKEYE 250 06-07	1011-2579	1011-2608
TRAILBLAZER 250 2-STR 02-08	1011-2579	1011-2608
SAWTOOTH 250 06-07	1011-2579	1011-2608
SPORTSMAN 300 08-09	1011-2579	1011-2608
TRAILBLAZER 330 08-12	1011-2579	1011-2608
MAGNUM 325-500 4-STR 02-03	1011-2579	1011-2608
MAGNUM 330 03-06	1011-2579	1011-2608
TRAILBOSS 330 08-13	1011-2579	1011-2608
TRAILBOSS 325 4-STR 01-09	1011-2579	1011-2608
MAGNUM 325 - 500 THRU 01	1011-2578	1011-2607
TRAILBOSS 325 THRU 00	1011-2578	1011-2607
XPEdition 325 - 425 00-03	1011-2578	1011-2607
SPORTSMAN 335-500 - 6X6 96-01	1011-2578	1011-2607
SPORTSMAN 400 - 6X6 02-13	1011-2578	1011-2607
SPORTSMAN 500 4-STR 02-13	1011-2578	1011-2607
XPLORER 500 01-02	1011-2579	1011-2608
SPORTSMAN 700 02-05	1011-2578	1011-2607
700 X2 08-09	1011-2578	1011-2607
SPORTSMAN 800 06-13	1011-2578	1011-2607
YAMAHA		
YFM250 BEAR TRACKER 00-05	1011-2593	-
YFM250 BIG BEAR 07-09	1011-2593	-
YFM350 BIG BEAR 00-02	1011-2593	-
YFM350X WARRIOR 86-05	1011-2594	1011-2615
YFM350 WOLVERINE 95-02	1011-2594	1011-2615
YFM400 BIG BEAR 03-12	1011-2593	-
YFM600/660 GRIZZLY 98-08	1011-2594	1011-2615

AIR FILTERS

Engineered for maximum air flow while increasing horsepower. Maintains premium protection by stopping the finest dust particles. Made of dual bonded foam for easier cleaning. Flexible seams that will not crack. Filters are designed to fit all stock air boxes. Made in the USA.



PPO (PRECISION PRE-OILED) AIR FILTERS

Same high-quality filters available pre-oiled. High technology machine pre-oils filter to perfection while leaving no excess. Includes re-sealable filter bag. Made in the USA.



FITS MODEL	DRY PART #	PRE-OILED PART #
ARCTIC CAT		
50/90/DVX90/UTILITY90 06-15	1011-3124	-
ALTEERRA 90 17	1011-3124	-
250/300 ALL MODELS 98-00	M763-10-01	1011-2544
250/300 01-02	M763-10-02	1011-1398
400/500 ALL MODELS 98-02	M763-10-02	1011-1398
400/500 03-05	1011-0023	1011-2553
400/500 14-15	1011-3709	1011-3716
ALTEERRA 400/450 16-17	1011-3709	1011-3716
ALTEERRA 400 17	1011-3709	1011-3716
450 CR/XC 10-14	1011-3709	1011-3716
454 BEARCAT ALL MODELS 96-00	M763-10-02	1011-1398
400 TRV/TBX/FIS 05-09	1011-0564	1011-2546
500 FIS AUTO 03-04	1011-1126	1011-3714
500 TBX/FIS 04	1011-1126	1011-3714
500 TBX/FIS 05-08	1011-0564	1011-2546
500 TRV 03-05	1011-1126	1011-3714
500 TRV AUTO 06	1011-0564	1011-2546
ALTEERRA 500 17	1011-3709	1011-3716
550 TRV/LTD/S/CRUISERS/ATV 08-15	1011-1455	1011-3715
ALTEERRA 550 17	1011-1455	1011-3715
650 H.I. 05-07	1011-0564	1011-2546
650 V-TWIN 04-07	1011-0564	1011-2546
PROWLER 650 06-07	1011-0564	1011-2546
PROWLER 650 HI 08-12	1011-1455	1011-3715
700 EXCL. DIESEL 06-12	1011-1125	1011-3713
PROWLER 700 HI 08-13	1011-1455	1011-3715
THUNDERCAT 1000 08-17	1011-1125	1011-3713
WILDCAT 1000I 12-13	1011-3236	-
700 EXCL. DIESEL 06-08	1011-1125	1011-3713
ALTEERRA 700 17	1011-1455	1011-3715
650 PROW/MUDP/LTD 650'S 08-12	1011-1455	1011-3715
700 PROW/TRV/S/CRUISE 700'S 08-14	1011-1455	1011-3715
700 XT/LTD/TRV 14-15	1011-1455	1011-3715
700 TBX 10-17	1011-1455	1011-3715
1000 THDR/TRV/MUDP 08-17	1011-1125	1011-3713
CRUISER 1000I 12	1011-1125	1011-3713
1000 XT EPS 17	1011-1125	1011-3713
1000 ALTEERRA TRV 17	1011-1125	1011-3713
1000 THDR/TRV/MUDP 08-17	1011-1125	1011-3713
1000 XT 16	1011-1125	1011-3713
CAN-AM		
300 OUTLANDER 04-05	1011-1130	1011-2790
400 OUTLANDER 03-07	1011-1130	1011-2790
500 OUTLANDER 07-12	1011-1129	1011-2534
500 RENEGADE 08-12	1011-1129	1011-2534
650 OUTLANDER 06-08	1011-1129	1011-2534
650 OUTLANDER EFI 10-12	1011-1129	1011-2534
800 OUTLANDER 06-08	1011-1129	1011-2534
800 OUTLANDER MAX 12	1011-1129	1011-2534
OUTLANDER MAX 800R 13-17	1011-3235	-
OUTLANDER 800R EFI 12-17	1011-3235	-
800 RENEGADE 07-08	1011-1129	1011-2534
800 RENEGADE EFI 09-12	1011-1129	1011-2534

FITS MODEL	DRY PART #	PRE-OILED PART #
AIR FILTERS (CON'T)		
CAN-AM (CON'T)		
RENEGADE 1000 12-13	1011-3235	-
OUTLANDER 1000 & MAX 1000 12-17	1011-3235	-
COMMANDER 800 11	1011-2796 2	-
COMMANDER 1000 11	1011-2796 2	-
RENEGADE 800 12-17	1011-3235	-
OUTLANDER 1000 & MAX 1000 12-17	1011-3235	-
650 OUTLANDER 13-17	1011-3235	-
OUTLANDER/OUTLANDER MAX 16 -17	1011-3235	-
OUTLANDER L / L MAX 16 -17	1011-3235	-
OUTLANDER 6X6 1000 EFI 16 -17	1011-3235	-
OUTLANDER 6X6 650 EFI 16 -17	1011-3235	-
E-TON		
IMPULSE TXL50/90 98	1011-0565	1011-3125
TXL 50/90 ALL YEARS	1011-0565	1011-3125
AXL 50/90 ALL YEARS	1011-0565	1011-3125
DX 90 ALL YEARS	1011-0565	1011-3125
HONDA		
TRX 90/90EX 93-17	M763-20-03	1011-2541
ATC110 79-82	M763-20-04	1011-2547
ATC110 83-85	M763-20-05	1011-0854
ATC125M 84-85	M763-20-05	1011-0854
ATC125M 86	M763-20-06	1011-0855
TRX125 84-86	M763-20-05	1011-0854
TRX125M 87-88	M763-20-06	1011-0855
ATC185S 81-82	M763-20-04	1011-2547
ATC185S 83-85	M763-20-05	1011-0854
ATC200 81-82	M763-20-04	1011-2547
ATC200 83-85	M763-20-05	1011-0854
ATC200E 82-83	M763-20-05	1011-0854
ATC200ES 84	M763-20-05	1011-0854
ATC200M 84-85	M763-20-05	1011-0854
ATC200S 84-86	M763-20-05	1011-0854
ATC200X 83-85	M763-20-07	1011-2542
ATC200X 86-87	M763-20-08	1011-2545
TRX200 84-86	M763-20-05	1011-0854
TRX200 89-98	M763-20-09	1011-2551
TRX200SX 86-88	M763-20-06	1011-0855
ATC250ES 85-87	M763-20-10	1011-0856
ATC250R 82	M763-20-11	-
ATC250SX 85-87	M763-20-12	1011-0857
TRX250D RECON 97-17	M763-20-14	1011-0858
TRX250 85-87	M763-20-12	1011-0857
TRX300 90-01	M763-20-17	1011-0860
TRX300FW 92-01	M763-20-17	1011-0860
FL350 ODYSSEY 85-86	M763-20-23	-
ATC350X 85-86	M763-20-08	1011-2545
TRX350 RANCHER ALL 00-06	M763-20-21	1011-0863
FL400 PILOT 89-90	M763-20-18	-
TRX350 4X4 86-89	M763-20-19	1011-0861
TRX400 4X4 FOREMAN 95-04	M763-20-17	1011-0860
AT400 RANCHER 04-07	M763-20-21	1011-0863
TRX420 RANCHER ALL PA 07-17	1011-1128	1011-1136
TRX420 RANCHER FA FE FM TE 14-17	M763-20-20	1011-0862
TRX450 ALL 98-06	M763-20-21	1011-0863
TRX500 RUBICON/FOREMAN 01-17	M763-20-20	1011-0862
TRX650/680 RINCON 03-17	M763-20-20	1011-0862
BIG RED 09-13	M763-20-20	1011-0862
PIONEER 500 15-17	M763-20-20	1011-0862
PIONEER 700 14-17	M763-20-20	1011-0862
KAWASAKI		
KLT160 85	M763-40-01	1011-1401
KLT185 86-87	M763-40-01	1011-1401
KLT200 81-84	M763-40-01	1011-1401
KLT250 82-85	M763-40-01	1011-1401
KLF185 BAYOU 86-88	M763-40-01	1011-1401
KLF220 BAYOU 88-01	M763-40-05	1011-0864
KLF250 BAYOU 03-11	M763-40-05	1011-0864
KLF300 BAYOU 86-88	M763-40-01	1011-1401
KLF 300 BAYOU 89-04	M763-40-06	1011-0865
KVF300 PRAIRIE 99-03	M763-40-09	1011-1402
KVF300 BRUTE FORCE 12-17	1011-3123	-
KVF360 PRAIRIE 02-13	1011-0020	1011-2539
KLF400 BAYOU 93-02	M763-40-07	-
KVF400 PRAIRIE 97-06	M763-40-09	1011-1402
KAF300 MULE ALL YEARS	M763-40-10	1011-1403

FITS MODEL	DRY PART #	PRE-OILED PART #
AIR FILTERS (CON'T)		
KAWASAKI (CON'T)		
KAF520 MULE ALL YEARS (NON 4X4)	M763-40-10	1011-1403
KVF650 PRAIRIE 4X4 02	M763-40-11	1011-3721
KVF650 PRAIRIE 4X4 03-06	1011-0021	1011-2536
KVF650 BRUTE FORCE 05-13	1011-0021	1011-2536
KVF650 I BRUTE FORCE 05-17	1011-0457	1011-1137
KFX700 V-FORCE 04-09	1011-0021	1011-2536
KVF700 PRAIRIE 04-09	1011-0021	1011-2536
KVF750 I BRUTE FORCE 05-17	1011-0457	1011-1137
TERYX 750 09-13	1011-2038	1011-2039
KYMCO		
250/300 MXU/MONGOOSE 05-09	1011-2795	-
POLARIS		
SPORTSMAN 90 01-06	1011-1127	1011-2537
SPORTSMAN 90 07-13	1011-1456	1011-3717
SPORTSMAN 110 16-17	1011-1456	1011-3717
RZR 170 11-13	-	1011-2787 ¹
SAWTOOTH 250 06-07	M763-15-04	1011-1400
HAWKEYE 250 06-07	M763-15-04	1011-1400
ALL 2-STROKE (EXCEPT 400L) 87-01	M763-15-01	1011-0852
ALL XPLORER 95-00	M763-15-01	1011-0852
XPLORER 01-02	M763-15-04	1011-1400
PHOENIX 200 06-16	M763-15-04	1011-1400
TRAILBLAZER 250 THRU 00	M763-15-01	1011-0852
TRAILBLAZER 250 01	M763-15-04	1011-1400
TRAILBOSS 250 THRU 01	M763-15-01	1011-0852
TRAILBLAZER 250 2-STR 02-09	M763-15-04	1011-1400
SPORTSMAN ACE 325 EFI 15-16	1011-3711	1011-3718
SPORTSMAN 450 EPS QUAD 16-17	1011-3711	1011-3718
SPORTSMAN 570 EPS QUAD 16-17	1011-3711	1011-3718
TRAILBLAZER 330 08-12	M763-15-04	1011-1400
SPORTSMAN 300 08-09	M763-15-04	1011-1400
MAGNUM 325-500 THRU 01	M763-15-05	1011-0853
MAGNUM 325-500 4-STR 02-03	M763-15-04	1011-1400
MAGNUM 330 03-06	M763-15-04	1011-1400
TRAILBOSS 325 THRU 00	M763-15-05	1011-0853
TRAILBOSS 325 4-STR 01-09	M763-15-04	1011-1400
TRAILBOSS 330 08-13	M763-15-04	1011-1400
XPEDITION 325-425 00-03	M763-15-05	1011-0853
SPORTSMAN 335-500-6X6 96-01	M763-15-05	1011-0853
SPORTSMAN 500 4-STR 02-13	M763-15-05	1011-0853
SPORTSMAN 400-4X4 & 6X6 02-13	M763-15-05	1011-0853
HAWKEYE 400 11-13	M763-15-05	1011-0853
MAGNUM 425 95-01	M763-15-02	1011-1399
SPORTSMAN 550 11-12	M763-15-05	1011-0853

FITS MODEL	DRY PART #	PRE-OILED PART #
AIR FILTERS (CON'T)		
POLARIS (CON'T)		
SPORTSMAN 570 14-15	M763-15-05	1011-0853
RANGER 570 EFI/INTL 14-17	1011-3711	1011-3718
RZR 570 12-17	1011-3283	-
SPORTSMAN 700 02-05	M763-15-05	1011-0853
700 X2 08-09	M763-15-05	1011-0853
SPORTSMAN 800 06-13	M763-15-05	1011-0853
SPORTSMAN 850 16-17	1011-3711	1011-3718
SPORTSMAN 1000 16-17	1011-3711	1011-3718
RZR 800 08-13	-	1011-1994 ¹
*REPLACEMENT FOAM SLEEVE FOR 1011-1994		
RANGER 400/500 MIDSIZE 12-13	-	1011-1995 ¹
RANGER 800/900 11-13	-	1011-1994 ¹
RANGER 2X4/4X4/6X6 06-11 (ALL EXCEPT RZR)	-	1011-1995 ¹
*REPLACEMENT FOAM SLEEVE FOR 1011-1995		
RANGER 900 EFI 13-17	1011-3283	-
RZR 900 EFI 11-13	-	1011-2789 ²
RZR XP1000 14-15	1011-3334	1011-3335
SUZUKI		
LTZ50 07-09	1011-0595	1011-2535
LT80 87-06	M763-70-03	1011-0866
ALT/LT125 83-89	M763-70-04	1011-0867
ALT/LT185 84-89	M763-70-04	1011-0867
LT160 91-04	M763-70-05	1011-2538
LT250 QUADRUNNER 85-90	M763-70-06	1011-2548
LT250 88-02	M763-70-07	1011-0868
LT250 OZARK 03-12	M763-70-12	1011-1405
LT300 KINGQUAD 99-03	M763-70-07	1011-0868
LT4 4WD KINGQUAD 91-03	M763-70-07	1011-0868
LT4 4WD QUADRUNNER 87-03	M763-70-07	1011-0868
LT450 KINGQUAD + CAGE 07-11	1011-0561	1011-0883
LT450 KINGQUAD 07-11	1011-0562	1011-0884
LT400 EIGER QUADRUNNER 02-07	M763-70-10	1011-1404
KING QUAD 400 08-13	M763-70-10	1011-1404
LT500 VINSON QUADMATIC 02-07	M763-70-10	1011-1404
LT500F QUADRUNNER 98-02	M763-70-09	1011-2543
LT500A QUADMASTER 00-01	M763-70-09	1011-2543
LT500 KINGQUAD AXI + CAGE 08-15	1011-0561	1011-0883
LT500 KINGQUAD AXI 08-15 1	1011-0562	1011-0884
LTV700 TWIN PEAK 04-06	1011-0021	1011-2536
LT700 KINGQUAD FILTER + CAGE 05-07	1011-0561	1011-0883

FITS MODEL	PART #	PART #
AIR FILTERS (CON'T)		
SUZUKI (CON'T)		
LT700 KINGQUAD FILTER 05-07 1	1011-0562	1011-0884
LT750 KINGQUAD FILTER + CAGE 07-15	1011-0561	1011-0883
LT750 KINGQUAD FILTER 07-15 ¹	1011-0562 ³	1011-0884 ³
YAMAHA		
YFM80-100 ALL YEARS	M763-80-10	1011-1407
YFA1 125 BREEZE 89-05	M763-80-03	1011-0871
YFM125 GRIZZLY 05-13	M763-80-03	1011-0871
YFM125/175 TRI-MOTO 82-85	M763-80-07	-
YFM200 MOTO 4 85-89	M763-80-06	1011-0874
YTM200 TRI-MOTO 83-86	M763-80-08	1011-2540
YTM225DX TRI-MOTO 83-86	M763-80-06	1011-0874
YFB250 TIMBERWOLF 92-00	M763-80-05	1011-0873
YFM250 BEAR TRACKER 00-05	M763-80-11	1011-0875
YFM250 BIG BEAR 07-09	M763-80-11	1011-0875
YFM350 BIG BEAR 87-99	M763-80-05	1011-0873
YFM350 BIG BEAR 00-02	M763-80-11	1011-0875
YFM350X WARRIOR 86-05	M763-80-04	1011-0872
YFM350 WOLVERINE 95-02	M763-80-04	1011-0872
YFM350 BRUIN 04-06	1011-0022	1011-2550
YFM350 WOLVERINE 06-09	1011-0980	1011-3722
YFM350X GRIZZLY 07-13	M763-80-13	1011-1408
YFM400 KODIAK 93-99	M763-80-05	1011-0873
YFM400 KODIAK 00-02	M763-80-09	1011-1406
YFM400 KODIAK 03-06	M763-80-13	1011-1408
YFM400 BIG BEAR 03-12	M763-80-11	1011-0875
YFM400 GRIZZLY 07-09	M763-80-13	1011-1408
YFM450 KODIAK 03-06	M763-80-13	1011-1408
YFM450 WOLVERINE 06-10	1011-0980	1011-3722
YFM450 GRIZZLY 07-13	M763-80-13	1011-1408
RHNO 450 06-10	1011-1030	1011-1031
GRIZZLY 550 09-13	1011-1133	1011-1138
YFM600/660 GRIZZLY 98-08	M763-80-04	1011-0872
RHINO 660 04-07	1011-1030	1011-1031
GRIZZLY 700 07-15	1011-1133	1011-1138
KODIAK 700 16-17	1011-3955	1011-3956
GRIZZLY 4WD 16-17	1011-3955	1011-3956
GRIZZLY 700 16-17	1011-3955	1011-3956
RHINO 700 FI 08-13	1011-1377	1011-1378
WOLVERINE 16-17	1011-3332	1011-3333
VIKING 14-15	1011-3332	1011-3333
YXZ1000 FIRST FILTER 16-17	1011-3712	1011-3724

¹ PAPER FILTER WITH FOAM SLEEVE

² PAPER FILTER

³ REPLACEMENT FILTER FOR MOOSE FILTER WITH CAGE MUST FIRST ORDER MOOSE FILTER CAGE KIT

HIGH PERFORMANCE 4-STROKE PISTON KITS BY CP PISTONS

Pistons feature x-style forgings and fully boxed-style (race pistons). Forgings come standard with skirt coating which reduces friction, which in return reduces heat. Our race piston kits include DLC pin. Internal bracing maximizes durability while decreasing friction in the pin assembly. This technology had been proven and used because of its high resistance to abrasive wear, which extends the service life and reliability under extreme conditions. Full radius dome designs maximize quench while eliminating hot spots that promote detonation. Each kit includes a piston, wrist pin, circlips and a top end gasket kit. Made in the USA.



STEEL DRIVE PLATES CLUTCH SPRINGS

Steel Drive Plates: Won't expand and fade like stock OEM plates. 300% longer life than stock. Sold in sets of six or seven.

Clutch Springs: precision wound using the finest chrome silicone wire. Heat-treated and shot peened for maximum life. Stronger than OEM springs.

FITS MODEL	BORE SIZE	PART #	CIRCLIPS	RING SET
KAWASAKI				
KVF BRUTE FORCE 750 11.0:1 08-14	85MM STD. BORE	0910-1715 ¹	-	0912-0295 ²
TERYX 750 11.0:1 08-16	85MM STD. BORE	0910-1715 ¹	-	0912-0295 ²
POLARIS				
SPORTSMAN 800R 11.0:1 08-14	80MM STD. BORE	0910-1717 ¹	-	0912-0296 ²
RZR 800 11.0:1 STD. BORE 08-14	80MM STD. BORE	0910-1717 ¹	-	0912-0296 ²
RZR 900XP 11.5:1 11-14	93MM STD. BORE	0910-2450 ^{1,3}	-	0912-0373 ²
RZR 900XP 11.5:1 15-18	93MM STD. BORE	0910-3668 ^{1,3}	-	-
RZR 1000XP 11.5:1 14-17	93MM STD. BORE	0910-3668 ^{1,3}	-	-
SUZUKI				
KING QUAD 700 11.5:1 05-07	102MM STD. BORE	0910-3669	-	0912-0581
KING QUAD 700 11.5:1 05-07 (+2MM OVERSIZE)	104MM BORE	0910-2445	-	-
YAMAHA				
RHINO 660 11.0:1 02-05	102MM +2 OVERSIZE	0910-3671	0913-0077	0912-0581
RHINO 700RI 11:1 06-15	102MM STD. BORE	0910-3672	-	0912-0581

¹ KIT INCLUDES TWO PISTONS ² TWO REPLACEMENT PARTS NEEDED ³ GASKET SET NOT INCLUDED

FITS MODEL	STEEL DRIVE PLATES PART #	CLUTCH SPRINGS PART #
STEEL DRIVE PLATES/CLUTCH SPRINGS		
HONDA		
TRX300 ALL MODELS 88-00	M80-7105-5	FHDS23-4
TRX350 ALL MODELS 86-89	M80-7105-5	-
TRX350 RANCHER 4X4 00-07	M80-7105-5	-
TRX400 FW 95-03	M80-7105-5	-
TRX450 FOURTRAX FOREMAN 99-01	M80-7105-5	FHDS23-4
TRX450 FOURTRAX FOREMAN 02-04	-	FHDS23-4
YAMAHA		
YFM350 BIG BEAR ALL 87-93	-	FHDS58-5
YFM400 BIG BEAR 4WD/2WD 01-06	-	FHDS80-5





PROMO
GARAGE
RIDER
ENGINE
BRAKING
SUSPENSION & DRIVE
WHEELS & TIRES
ELECTRICAL
CONTROLS
BODY
LUGGAGE
IMPLEMENTS & TOWING
RACKS
UTV
WINCHES
PLOWS



M.U.D. RIDING GLOVE

The ultimate glove for hunter, rancher and/or farmer with an ATV or UTV. Water resistance and windproof top hand fabric for warmth and comfort. Slim fit, genuine leather palm and Ax™ Suede connect finger panels allows interaction with touchscreen devices. Tac-grip printing and pre-curved finger design. Flexible top hand and finger panels. Light-weight lining fabric for moisture control and added comfort. Leather thumb and fingertips. Hook and loop cuff strap adjustment.

SIZE	PART #
SM	3330-6155
MD	3330-6156
LG	3330-6157
XL	3330-6158
2X	3330-6159



UNRELENTING TEE

60% Cotton / 40% Polyester blend fabric. Direct screen print graphics. Made in the USA.

SIZE	PART #	SIZE	PART #
SM	3030-18634	XL	3030-18637
M	3030-18635	2X	3030-18638
L	3030-18636	3X	3030-18639



M.U.D. TEE

Cool pre-shrunk, 100% cotton Direct screen print graphics. Made in the USA.

SIZE	PART #	SIZE	PART #
MD	3030-15965	2X	3030-15968
LG	3030-15966	3X	3030-15969
XL	3030-15967		



AGROID VARIANCE TEE

60% Cotton / 40% Polyester blend fabric. Direct screen print graphics. Made in the USA.

SIZE	PART #	SIZE	PART #
SM	3030-18532	XL	3030-18535
M	3030-18533	2X	3030-18536
L	3030-18534	3X	3030-18537



UNRELENTING HOODY

80% cotton / 20% polyester fabric. Direct screen print graphics. Made in the USA.

SIZE	PART #	SIZE	PART #
SM	3050-5188	XL	3030-5191
M	3030-5189	2X	3030-5192
L	3030-5190	3X	3030-5193



M.U.D. KRYPTEK CAMO HAT

Stitched patch. Mesh back. Snapback.

DESCRIPTION	PART #
M.U.D. KRYPTEK CAMO HAT	2501-3271



AGROID VARIANCE HOODY

52% cotton / 48% polyester fabric. Direct screen print graphics. Made in the USA.

SIZE	PART #	SIZE	PART #
SM	3050-5160	XL	3030-5163
M	3030-5161	2X	3030-5164
L	3030-5162	3X	3030-5165



AGROID VARIANCE HAT

Stitched patch. Snapback.

DESCRIPTION	PART #
AGROID VARIANCE HAT	2501-3270

PLOWES

WINCHES

UTV

RACKS

IMPLEMENTES & TOWING

LUGGAGE

BODY

CONTROLS

ELECTRICAL

WHEELS & TIRES

SUSPENSION & DRIVE

BRAKING

ENGINE

RIDER

GARAGE

PROMO



MIPS® NEW MIPS® TECHNOLOGY!

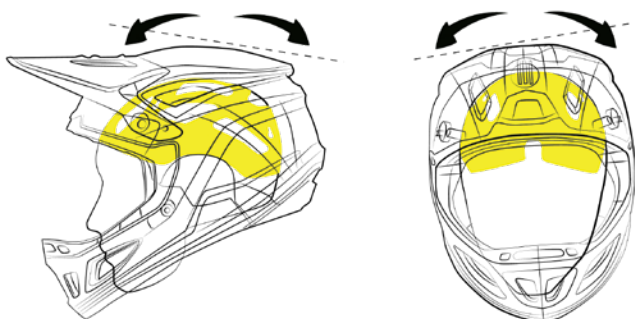

HOW MIPS® WORKS

In a helmet with MIPS Brain Protection System (BPS) there is a Low Friction Layer that separates your head and the helmet. When a helmet with MIPS® BPS is subjected to an angled impact, the low friction layer allows the helmet to slide relative to the head. The MIPS® BPS is designed to add protection in helmets against the rotational motion. The rotational motion is a combination of rotational energy (angular velocity) and rotational forces (from angular acceleration) that both may affect the brain and increase the risk for minor and severe brain injuries. MIPS® BPS has been scientifically proven to reduce rotational motion in certain impacts when implemented in a helmet by absorbing and redirecting rotational energies and forces that otherwise may be transferred to the brain.

F.I. SESSION HELMET

Helmet is equipped with MIPS® technology. Multi density EPS liner for impact absorption. Injection molded polycarbonate shell is lightweight, compact and strong. Nine intake and three exhaust vents feed into the internal air channels providing excellent ventilation. Unique friction hinge visor is easily adjusted and secure. Extra-large eye port for excellent field of vision. Fully removable moisture wicking liner and cheek pads. Nose guard provides excellent coverage from roost and is removable. Two shell sizes and two EPS sizes engineered for optimum fit. DOT and ECE approved.

SIZE	BLACK/WHITE	BLACK/HI-VIZ	BLACK/BLUE	RED/WHITE	MATTE BLACK
XS	0110-5724	0110-5731	0110-5738	0110-5745	0110-6472
SM	0110-5725	0110-5732	0110-5739	0110-5746	0110-6473
MD	0110-5726	0110-5733	0110-5740	0110-5747	0110-6474
LG	0110-5727	0110-5734	0110-5741	0110-5748	0110-6475
XL	0110-5728	0110-5735	0110-5742	0110-5749	0110-6476
2X	0110-5729	0110-5736	0110-5743	0110-5750	0110-6477
3X	0110-5730	0110-5737	0110-5744	0110-5751	0110-6478

HELMET SIZING CHART						
SHELL SIZE	XS	S	M	L	XL	2X
HAT SIZE	6 5/8 - 6 3/4	6 7/8 - 7	7 1/8 - 7 1/4	7 3/8 - 7 1/2	7 5/8 - 7 3/4	7 7/8 - 8
INCHES	20 7/8 - 21 1/4	21 5/8 - 22	22 3/8 - 22 3/4	23 1/8 - 23 1/2	24 - 24 3/8	24 3/4 - 25 1/8
CENTIMETERS	53 - 54	55 - 56	57 - 58	59 - 60	61 - 62	63 - 64

SAFETY WARNING: Riding a motorcycle, ATV or UTV is a dangerous activity. When riding, always wear a helmet, eye protection and protective clothing. There is no assurance that serious injury or death can be avoided even if you wear the product shown in this catalog and take all precautions to avoid every risk. Please ensure that your Moose Racing® products fit properly. Improperly fitting products can impair your ability to control your motorcycle, ATV or UTV.



DUST MASK

Protects your mouth and your nose from harmful dust as you head down the trail. Sewn in interior filter blocks 99.5% of all dust particulates. Two one-way exhaust valves which reduces lens fogging, releases heat, CO², and water vapor. Patent pending 3D Nosebox™ and upgraded nose clip. Comfortable for most men, women, and children. Universal size accommodates neck sizes up to 45,5 cm (18"). Helmet and goggles compatible. Washable and reusable.

DESCRIPTION	PART #
DUST MASK	2503-0330



ATV SOLE

M1.3™ ATV BOOT

Chassis is constructed with polyurethane coated synthetic leather that is abrasion resistant and flexible. Reinforced TPU shin, ankle, and foot plates are engineered to improve stability without sacrificing mobility. Low profile compact lower toe box improves brake feel and ability to shift. Integrated internal lace loop system secures foot and increases ankle stability. Heavyweight suede leather inner calf guard improves abrasion and heat resistance. Rigid steel shank reinforced sole eliminates flex and provides superior foot support. Polyurethane plastic closure strap with metal buckle is adjustable and secure. Internal soft EVA foam reinforced in impact areas improves comfort. Multi-layer synthetic rubber outsole is long lasting and provides superior grip. Polyester inner lining wicks moisture. Tested and certified according to European standard EN 13634:2015.

SIZE	BLACK	SIZE	BLACK
7	3410-1997	12	3410-2002
8	3410-1998	13	3410-2003
9	3410-1999	14	3410-2004
10	3410-2000	15	3410-2005
11	3410-2001		

M1.3™ ADULT ATV BOOT SIZE GUIDE

USA SIZE	7	8	9	10	11	12	13	14	15
EURO SIZE	40	41.5	43	44	45	46	47	48.5	50
UK	6.5	7.5	8.5	9.5	10.5	11.5	12.5	13.5	14.5
JAPAN	25	26	27	28	29	30	31	32	33
INSIDE LENGTH (INCHES)	10.2	10.4	10.8	11.2	11.4	11.8	12.2	12.5	12.9
INSIDE LENGTH (CM)	26	26.5	27.5	28.5	29	30	31	32	33



BOOT, HELMET & GLOVE DRYER

PEET® multi dryer provides convection air technology that circulates air to safely dry footwear, gloves and helmets. Eliminates odor caused by perspiration and bacteria. Removes mold and mildew that deteriorates linings. Two dryports for gloves, one dryport for helmet and four footwear dryports included. Does not get hot or blow hot air. Dryports must be used for drying all gear. 220-volt. Gloves, boots and helmet not included.

DESCRIPTION	PART #
BOOT, HELMET & GLOVE DRYER	3430-0465

SAFETY WARNING: Riding a motorcycle, ATV or UTV is a dangerous activity. When riding, always wear a helmet, eye protection and protective clothing. There is no assurance that serious injury or death can be avoided even if you wear the product shown in this catalog and take all precautions to avoid every risk. Please ensure that your Moose Racing® products fit properly. Improperly fitting products can impair your ability to control your motorcycle, ATV or UTV.



QUALIFIER SLASH GOGGLE

Flexible, yet durable molded goggle frame with venting. Optically pure clear polycarbonate lens with scratch resistant and anti-fog coating. Large eye port for maximum vision in all directions. Elastic strap (tested and certified according to European Standard EN 1938-2010, with tacky grip print to hold goggle in place. Molded face foam provides secure fit and seals out dust and dirt.

NOTE: Replacement lenses available; see mooseracing.com.

COLOR	PART #	COLOR	PART #
WHITE/BLACK	2601-2505	GREEN/BLACK	2601-2120
PINK/BLACK	2601-2506	ORANGE/BLACK	2601-2121
BLACK/WHITE	2601-2118	RED/BLACK	2601-2122
BLUE/WHITE	2601-2119	HI VIZ	2601-2123

SAFETY WARNING: Riding a motorcycle, ATV or UTV is a dangerous activity. When riding, always wear a helmet, eye protection and protective clothing. There is no assurance that serious injury or death can be avoided even if you wear the product shown in this catalog and take all precautions to avoid every risk. Please ensure that your Moose Racing® products fit properly. Improperly fitting products can impair your ability to control your motorcycle, ATV or UTV.



CAMO



HATCH



XCR CAMO & HATCH GOGGLE

Soft multi-density foam with fleece backing improves comfort, provides excellent moisture management and seals out dirt. Optically pure polycarbonate lens with scratch resistant and anti-fog coating. Large eye port for maximum viewing. Injected polyurethane frame is flexible and durable. Ventilated frame drives out heat and perspiration. Outrigger system designed to create a consistent seal and balanced fit. Elastic strap with tacky silicone print secures goggle. Integrated nose guard for maximum roost coverage. Tested and certified according to European standard EN 1938:2010.

NOTE: Replacement lenses available; see mooseracing.com.

COLOR	PART #	COLOR	PART #
CAMO GRAPHIC	2601-2341	HATCH GRAPHIC	2601-2345
GREEN/BLACK	2601-2342	BLACK/Hi-VIZ	2601-2346
YELLOW/ORANGE	2601-2343	BLACK/ORANGE	2601-2347
BLUE/ORANGE	2601-2344	BLUE/RED	2601-2348
BLACK	2601-2344	GREEN/YELLOW	2601-2348

SAFETY WARNING: Riding a motorcycle, ATV or UTV is a dangerous activity. When riding, always wear a helmet, eye protection and protective clothing. There is no assurance that serious injury or death can be avoided even if you wear the product shown in this catalog and take all precautions to avoid every risk. Please ensure that your Moose Racing® products fit properly. Improperly fitting products can impair your ability to control your motorcycle, ATV or UTV.



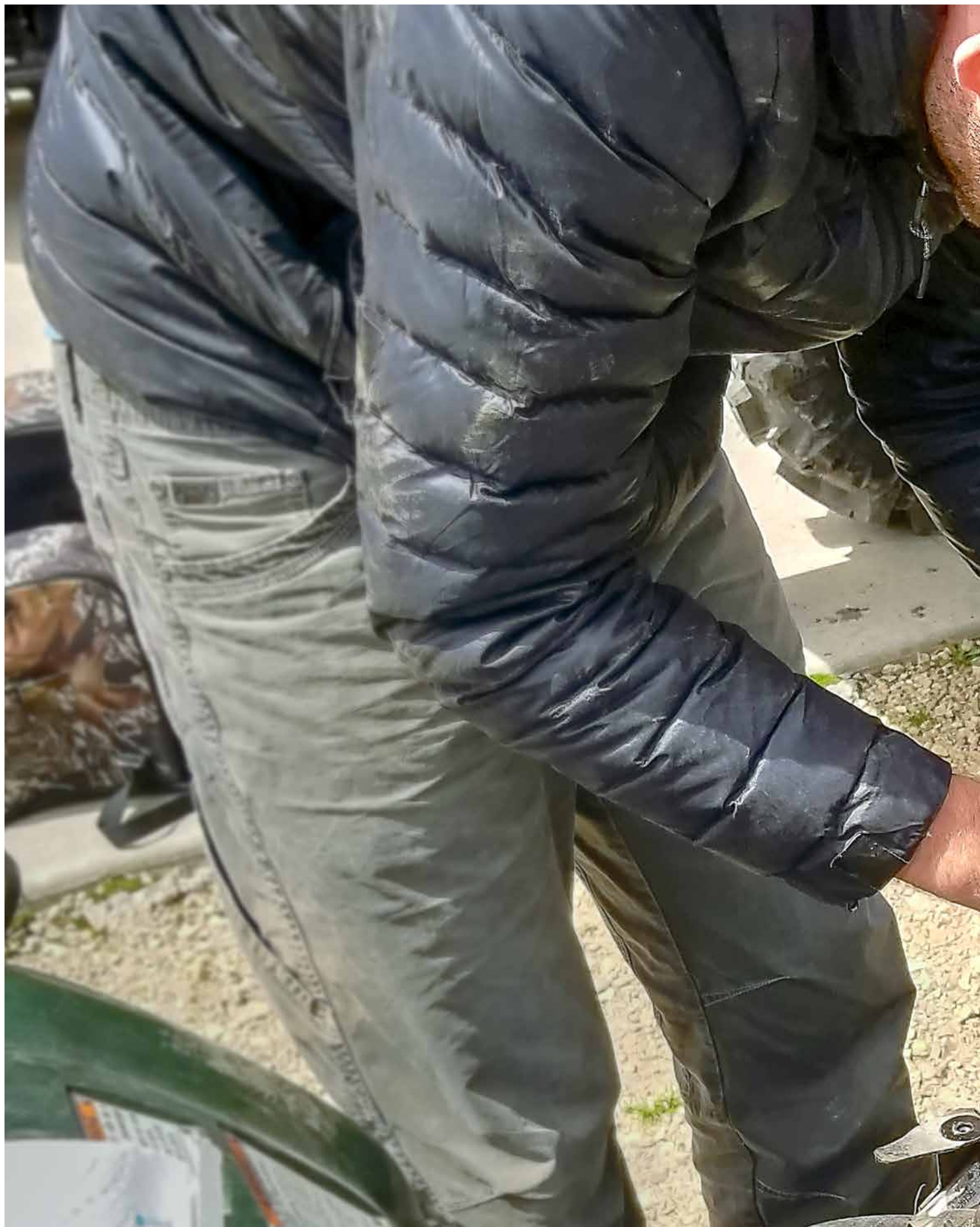



PLOWS

WINCHES

UTV

RACKS

IMPLEMENTS
& TOWING

LUGGAGE

BODY

CONTROLS

ELECTRICAL

WHEELS
& TIRES

SUSPENSION
& DRIVE

BRAKING

ENGINE

RIDER

GARAGE

PROMO

GARAGE

STANDARD



RATCHET



QUAD PACK



HEAVY-DUTY TIE-DOWNS

High-quality tie-downs that last. 183 cm (6') L x 25 mm (1") W. Two oversized, high-strength rubber coated hooks. Straps are printed with the Moose Utility Division® logo. Choice of standard, ratchet or quad pack which includes both. Ratchet: 2000 lb; Standard: 1350 lb. Made in the USA.

DESCRIPTION	PART #
25 MM (1") STANDARD TIE-DOWNS	
BLACK	3920-0294
RED	3920-0295
BLUE	3920-0296
25 MM (1") RATCHET TIE-DOWNS	
BLACK	3920-0297
RED	3920-0298
BLUE	3920-0299
QUAD PACK-TIE-DOWNS 1 PAIR RATCHET/1 PAIR STANDARD	
BLACK	3920-0300

25 MM (1") SOFT TIE EXTENSIONS

Perfect for bars or secure areas too thick for hooks. Won't scratch paint or plastic. 45.5 cm (18") length. 4500 lb test nylon webbing. Made in the USA.

DESCRIPTION	PART #
BLACK	3920-0307
RED	3920-0308
BLUE	3920-0309



CARABINER TIE-DOWN

Makes securing your machine an easier job. One high-strength rubber coated hook and one high-strength carabiner. 25 mm (1") wide straps are printed with the Moose Racing® logo and identification tag. Built in soft tie helps prevent damage to your machine. 213 cm (7') long (30.5 cm (1") longer than industry standard), 1350 lb break strength. 425 lb working load limit. Sold in pairs. Made in the USA.

DESCRIPTION	PART #
BLACK	3920-0305
RED	3920-0355
BLUE	3920-0356
ORANGE	3920-0357



SOFT SHACKLE

Abrasion resistant collar. Pull cord release. 8 mm (5/16") size with 8 mm braided strands.

DESCRIPTION	PART #
SOFT SHACKLE	4505-0754



TOW STRAP

4,6 m (15') polyester strap with two heavy-duty forged steel hooks. 10000 lb tensile strength. Made in the USA.

DESCRIPTION	PART #
TOW STRAP	3920-0306



SWIVEL CARABINER TIE-DOWN

183 cm (6') L x 38 mm (1 1/2") W. Oversized high-strength rubber coated hook on one end. Swivel carabiner hook means no more twisted straps. Standard weight capacity; 1850 lb Ratchet weight capacity; 2000 lb Sold in pairs. Made in the USA.

DESCRIPTION	PART #
STANDARD	3920-0338
RATCHET	3920-0339

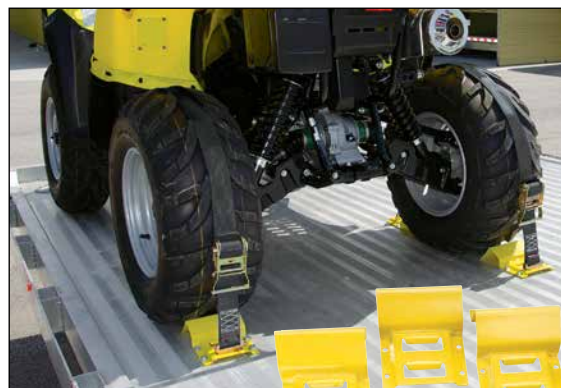
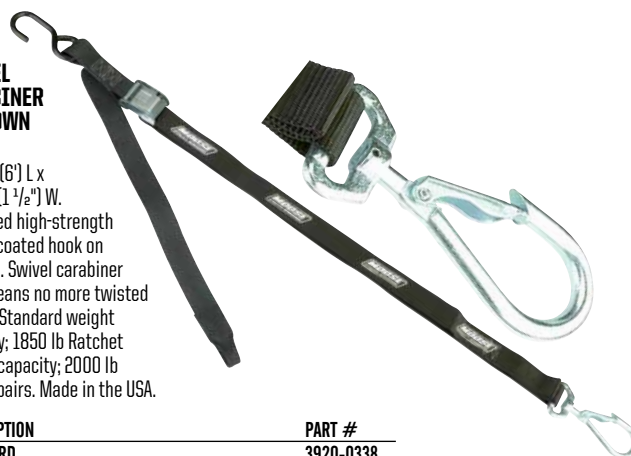

WHEEL CHOCK AND TIE-DOWN STRAP KIT

Maximum vehicle weight 1500 lbs (680 Kg). Use on both rear wheels. Secure your atv or other off-road vehicle during transport. Heavy-duty 51 mm (2") webbing wraps around wheels. Eliminates the hassle of tangled tie-down straps. Kit includes: 4 powder coated e-track wheel chocks, 2- 51 mm (2") x 183 cm (6') e-track ratchet straps. Straps will work on tires as small as 25,5 cm (10") and as large as 76 cm (30") in diameter. Double slotted e-fitting allows for proper hook up on large and small tires. Wheel chocks are permanently mounted, simply drive over over brackets for loading and unloading. Hardware is not included.

DESCRIPTION	PART #
WHEEL CHOCK AND TIE-DOWN STRAP KIT	3920-0399



3910-0008
107 cm (42") - 132 cm (52") W x 193 cm (76") L,
566 kg (1250 lb) capacity



MUDRAMP4685
117 cm (46") W x 216 cm (85") L;
544 kg (1200 lb) capacity

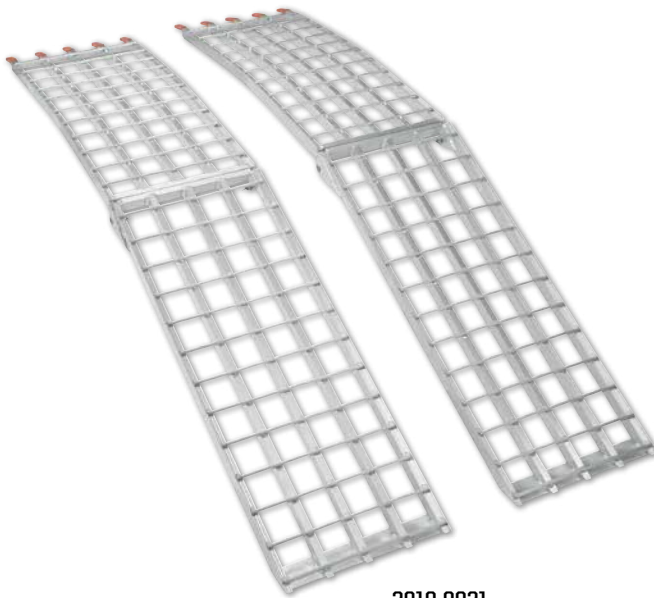

3910-0031
45,5 cm (18") W x 241 cm (95") L each;
1134 kg (2500 lb) capacity



MUDRAMP4871
122 cm (48") W x 180 cm (71") L;
453 kg (1000 lb) capacity



MUDRAMP1290P
30,5 cm (12") W x 229 cm (90") L each;
544 kg (1200 lb) capacity

ALUMINUM RAMPS

Durable and lightweight. Weather resistant and comes with sturdy aluminum frames. Bar style surface for better traction. Come with EZ grip rubber rests and nylon straps. WARNING: DO NOT RIDE ON RAMPS AT ANYTIME.

DESCRIPTION	PART #
TRI-FOLD ADJUSTABLE ALUMINUM RAMP	
107 CM (42") - 132 CM (52") W X 193 CM (76") L	3910-0008
TRI-FOLD ALUMINUM RAMP	
117 CM (46") W X 216 CM (85") L	MUDRAMP4685
UTV ALUMINUM RAMP	
45,5 CM (18") W X 241 CM (95") L (SOLD IN PAIRS)	3910-0031
BI-FOLD ADJUSTABLE ALUMINUM RAMP	
122 CM (48") W X 180 CM (71") L	MUDRAMP4871
ARCHED FOLDING ALUMINUM RAMP	
30,5 CM (12") W X 229 CM (90") L (SOLD IN PAIRS)	MUDRAMP1290P
RAMP REPLACEMENT STRAPS	3910-0028



TOOL WRAP

An easy way to organize and carry your tools and other supplies. Rugged 500 denier tarpaulin material construction protects your cargo and easily handles the rigors of off-road, competition, dual sport or adventure touring use, and is easy to clean. Revised shape better secures and segregates your tools, and includes a small zipper bag for odds and ends like fuses and chain master links. This wrap rolls tight, collapsing around your tools, to save you room when you stow it in your backpack or rear fender pack. YKK zippers. Closed Pack Size: 25,5 cm (10") L x 14 cm (5 1/2") W x 25 mm (1") H. Contents not included.

DESCRIPTION	PART #
TOOL WRAP	3510-0084



SPARK PLUG CARRIERS

Impact-resistant plastic design fits snug around spare spark plug. Perfect for fanny pack or fender bag. Keeps plug clean and gapped. Sold in pairs.

DESCRIPTION	PART #
SPARK PLUG CARRIERS	2103-0215



PLUG WRENCH

Plug wrench for water cooled 2-strokes has a 12 point, broached wrench for tight situations. Handle can be custom bent for a better fit on your application. Fits standard 20,6 mm (1 3/16") plug size. Made in the USA.

DESCRIPTION	PART #
AIR COOLED PLUG WRENCH	M204
WATER PUMP PLUG WRENCH	M205



SAFETY WIRE

Stainless steel safety wire. Spooled on a convenient plastic casing. Spool perfect size for storage compartment or fanny pack. 1 lb can is perfect for shop or garage use. Available in two different diameters. Made in the USA.

DESCRIPTION	PART #
WIRE 0,7 MM (0.028") X 36,5 M (120')	M112-0028
WIRE 0,8 MM (0.032") X 22,8 M (75')	M112-0032
1 LB CAN 0,7 MM (0.028")	3850-0210
1 LB CAN 0,8 MM (0.032")	3850-0126



SAFETY WIRE DRILL JIG KIT

Nut drill jig allows the safety wire holes to be drilled through the head of bolts or through nuts. It will accept up to a 3,5 mm diameter. Metric bolt drill jig provides six drill holes for metric sizes: 6 x 1.0, 8 x 1.0, 8 x 1.25, 10 x 1.5 and 12 x 1.5 bolts.

DESCRIPTION	PART #
SAFETY WIRE DRILL JIG KIT	3850-0404



EMERGENCY CABLE REPAIR KIT

Contains cable components to repair many types of cables. Two wire diameter sizes, and assortment of cable ends for throttle, brakes and clutch. Small and compact container to carry on the road or off. A must have for older machines.

DESCRIPTION	PART #
EMERGENCY CABLE REPAIR KIT	0660-0012

SUPER SIPHON

Dangerous liquids and chemicals can be transferred without fear of injury. Works with almost all liquids including water, gas, diesel, kerosene, paint and thinners. 12,7 mm (1/2") diameter.



DESCRIPTION	PART #
SUPER SIPHON	0706-0226

OIL ABSORBENT PADS

Perfect for shop use; under stored vehicles, on shop benches to hold tool/parts, for mess-free carburetor repairs or any fuel or oil related repairs. Will not absorb water. Can be wrung out and re-used. Absorbs 13 to 25 times its weight in oil and related liquids. Dimensions: 43 cm (17") x 48,5 cm (19") sheets. Sold in five packs. Made in the USA.



DESCRIPTION	PART #
OIL ABSORBENT PADS	3850-0397



2-PIECE FUNNEL

Multi-use 2-piece funnel. 305 mm (12") detachable flexible spout. Includes easy grip handle. 381 mm (15") overall length. 152 mm (6") diameter. 19,1 mm (3/4") O.D. tip.

DESCRIPTION	PART #
2-PIECE FUNNEL	3850-0202



EASY POUR FLEX SPOUT

Multi-purpose flexible funnel spout. Double threads to fit most containers. Complete with stopper cap and hang tab. 235 mm (9 1/4") length. 19,1 mm (3/4") O.D. tip.

DESCRIPTION	PART #
EASY POUR FLEX SPOUT	3850-0201



4-IN-1 MAGNETIC SCREWDRIVER

Fishbowl display contains 20 screwdrivers. Screwdriver contains extension, two Phillips and two flat bits. Great for fanny packs. Fishbowl sold to dealers. Each sold to consumers. Made in the USA.



DESCRIPTION	PART #
4-IN-1 MAGNETIC SCREWDRIVER	3850-0092



TWO IN ONE HEX/SOCKET WRENCH SET

Special design hex key wrenches that let you use hex or socket. Hex and ball sizes - 5 mm, 6 mm, 7 mm, 8 mm, 9 mm and 10 mm. Socket sizes - 5 mm, 6 mm, 7 mm, 8 mm, 9 mm and 10 mm. Comes with reusable pouch.

DESCRIPTION	PART #
TWO IN ONE HEX/SOCKET WRENCH SET	3812-0606



TWO IN ONE HEX/STAR WRENCH SET

Special design hex key wrenches that let you use star or hex socket. Torx sizes: T20, T25, T30, T40, T45 and T50. Hex sizes: 5 mm, 6 mm, 7 mm, 8 mm, 9 mm and 10 mm. Comes with reusable pouch.

DESCRIPTION	PART #
TWO IN ONE HEX/STAR WRENCH SET	3812-0607



10-PIECE HEX WRENCH SET

Made from high-quality chrome vanadium. Comes with plastic holder. Includes sizes 1,5 mm thru 10 mm.

DESCRIPTION	PART #
10-PIECE HEX WRENCH SET	3812-0043



T-HANDLE DRIVER SOCKET SET

Drop forged "T" shaft. Socket sizes: 8 mm, 10 mm and 12 mm. Measures 178 mm (7").

DESCRIPTION	PART #
T-HANDLE DRIVER SOCKET SET	3812-0608



CROSS SCREW DRIVER TOOL SET

Cross shaped handle has die cast construction. The cross is a mini 3-way with 8 mm, 9 mm and two 10 mm sockets. The two 10 mm sockets are for the bits included. Hex bit sizes: 2 mm, 2,5 mm, 3 mm, 4 mm 5 mm and 6 mm Star bit size: T25. Screwdriver bit sizes: Phillips #2 and slotted 4 mm.

DESCRIPTION	PART #
CROSS SCREW DRIVER TOOL SET	3850-0402



GASKET SCRAPER TOOL

Perfect size for ATV and motorcycle repairs and maintenance. Strong pressed steel blade w/plastic handle. Blade width 25,4 mm (1"), overall length 279 mm (11").

DESCRIPTION	PART #
GASKET SCRAPER TOOL	3850-0401



NYLON RATCHET CLAMPS

One-piece, space saver, quick release and no special tools needed. Black in color. Available in 16-8-100 packs. 16-pack size breakdown: 4 pcs - 8 mm; 4 pcs - 9 mm; 4 pcs - 10 mm; and 4 pcs - 12 mm. 100-pack size breakdown: 25 pcs - 8 mm; 25 pcs - 9 mm; 25 pcs - 10 mm; and 25 pcs - 12 mm. Made in the USA.

DESCRIPTION	PART #
NYLON RATCHET CLAMPS	
16-PACK	2402-0164
100-PACK	2402-0165



STAINLESS STEEL CABLE TIES

Perfect for high temperature applications. Ball bearing and barb fastening assembly locks tightly and will not slip. Use anywhere a normal cable tie isn't strong enough or can't take the heat. Two lengths available, sold in packs of five. Made in the USA.

DESCRIPTION	PART #
203 MM (8")	2120-0144
356 MM (14")	2120-0145

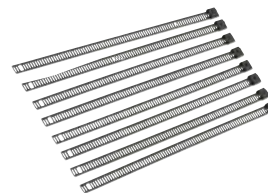

LADDER STYLE CABLE TIES

Self-locking design for fast and secure installation. Made from 316 stainless steel and ideal for applications that involve corrosion, vibration and high temperatures. Compatible and look great when used to install exhaust and header wraps. Available in two colors; natural silver stainless steel and black polyester powder coated black. Available in 203 mm (8") and 356 mm (14") lengths. Sold in eight packs.

DESCRIPTION	PART #
203 MM (8") SILVER	2120-0642
203 MM (8") BLACK	2120-0643
356 MM SILVER	2120-0644
356 MM BLACK	2120-0645



CABLE TIES

These ties are made of strong 6/6 nylon. They have UV additive so they will not fade or get brittle. Available in a 30-pack and available in an assortment of sizes; 10 cm (4"), 15 cm (6") & 21 cm (8") lengths. Available in white, black, gray and orange. Made in the USA.

DESCRIPTION	PART #
WHITE	2404-0586
BLACK	2404-0587
GRAY	2404-0588
ORANGE	2404-0589

4-WAY TIRE VALVE REPAIR TOOL

Repairs core and stem threads. Has core screwdriver and broken core extractor. Very small and compact.



DESCRIPTION	PART #
4-WAY TIRE VALVE REPAIR TOOL	3810-0032



ALUMINUM VALVE CORE TOOL

All aluminum with knurled handle. Used to remove and install tire valve cores.

DESCRIPTION	PART #
ALUMINUM VALVE CORE TOOL	3810-0033



VALVE CORE TOOL

Screwdriver handle Valve Core Tool. For extracting and installing tire valve cores.

DESCRIPTION	PART #
VALVE CORE TOOL	3810-0031



TY-ER IRONS

Ergonomic plastic molded handle for increased comfort. Spooned end prevents tubes from pinching. Zinc coated steel. Measures 267 mm (10 1/2") long. Sold in pairs. Made in the USA.

DESCRIPTION	PART #
TY-ER IRONS	M01066



MIGHTY TIRE IRON

Long heavy-duty tire iron for increased leverage. Handle design eases workload by reducing discomfort and fatigue. The iron is made of chrome vanadium and the spoon design prevent pinching of tubes. Made in the USA.

DESCRIPTION	PART #
MIGHTY TIRE IRON	3810-0068



RADIATOR FIN STRAIGHTENER

Handy six-in-one straightener. Straighten damaged fins and remove debris without danger of puncture. Straightener sections are clearly marked for fin size. Compact enough to use even in confined spaces. The straightener head is 79.4 mm (3 1/8") in diameter and the handle is 88.9 mm (3 1/2") long. Straightens 8, 9, 10, 12, 14 and 15 fins per inch. A quick tool for putting all those cooling fins back to work!

DESCRIPTION	PART #
RADIATOR FIN STRAIGHTENER	3850-0263



HEAVY-DUTY PULLEY, SPROCKET, GEAR HOLDER

This holding tool can be a big help when removing pulleys, gears or sprockets. Wide range of adjustability. Two secure pins of two different sizes allow a fit for most applications.

DESCRIPTION	PART #
HEAVY-DUTY PULLEY, SPROCKET, GEAR HOLDER	3808-0015



FLYWHEEL PULLER SET

Metric 10 piece puller set. Has thread pitch and size combinations to fit almost all ATVs and UTVs. Made from high grade steel. Storage case included.

DESCRIPTION	PART #
FLYWHEEL PULLER SET	3802-0056

FLYWHEEL PULLER SET SIZES

M14 X PITCH 1.5	M22 X PITCH 1.5	M25 X PITCH 1.5
M19 X PITCH 1.0	M26 X PITCH 1.0	M27 X PITCH 1.0
M16 X PITCH 1.5	M27 X PITCH 1.25	M22 X PITCH 1.0
M26 X PITCH 1.5	M28 X PITCH 1.0	M24 X PITCH 1.0
M18 X PITCH 1.5	M20 X PITCH 1.0	M28 X PITCH 1.5



UNIVERSAL METRIC AND SAE 270PC O-RING ASSORTMENT

High temperature (700°F), oil, gas, coolant and chemical resistant. Used to seal oil lines, fuel system components and coolant passages on motorcycles, ATV, UTV, PWC, and snowmobiles.

DESCRIPTION	PART #
UNIVERSAL METRIC AND SAE 270PC O-RING ASSORTMENT	2402-0163



FLYWHEEL PULLER

M33xP1.5 flywheel puller with right-hand thread. Compare to OEM PA-46075. Fits Polaris Outlaw 500 03-07, Polaris Predator 500, Adly 500/500s, Suzuki LT250 Ozark, Yamaha YZF450 04-07 and WR450F 04-06.



DESCRIPTION	PART #
FLYWHEEL PULLER	3801-0326

POLARIS WATER PUMP DRIVE & ROTOR SERVICE TOOL

Compare to OEM PA-49316. Designed for removing and installing the water pump drive gear on the rotor and to remove the rotor from the crankshaft. Fits most Polaris ATV and Side x Side models and also works on the RZR XP.



DESCRIPTION	PART #
WATER PUMP DRIVE & ROTOR SERVICE TOOL	3801-0327

POLARIS TRANSMISSION LOCKING TOOL

Removes locking nut on the transmission output. For Polaris Phoenix 05-17. Compare to OEM PA-47309.



DESCRIPTION	PART #
POLARIS TRANSMISSION LOCKING TOOL	3802-0073

POLARIS/KAWASAKI CLUTCH SPIDER NUT DRIVER

For servicing or rebuilding a clutch. Compare to Polaris OEM #2870338. Fits P85 and P90 clutches found on Polaris ATVs and snowmobiles 72-present (except 900 RZR XP 4x4 11-12 and 900 RZR XP 4 4x4 12) and Kawasaki 300/400 Prairie and 4x4 99-02. Use with PART #3803-0174.



DESCRIPTION	PART #
POLARIS/KAWASAKI CLUTCH SPIDER NUT DRIVER	3803-0173

POLARIS CLUTCH SPIDER NUT DRIVER

For servicing or re-building a Polaris clutch. Compare to Polaris OEM #2870341. Fits P85 and P90 clutches found on Polaris ATVs, Side x Sides and snowmobiles 72-present. Use with PART #3803-0173.



DESCRIPTION	PART #
POLARIS CLUTCH SPIDER NUT DRIVER	3803-0174

HONDA CLUTCH PULLER

Fits most 4-stroke Honda four-wheelers except Rubicon. Has both male and female threads. Puller bolt installs in either end of the tool. Compare to OEM 07933-HB3000A. For TRX400EX FourTrax 99-00, TRX400FW FourTrax Foreman 95-03, TRX450ES FourTrax Foreman 4x4 ES 98-01, TRX450S FourTrax Foreman 4x4 S 98-99, TRX450S FourTrax Foreman 2000 and TRX500FA FourTrax Foreman Rubicon 4x4 AT 00-01.



DESCRIPTION	PART #
HONDA CLUTCH PULLER	3803-0175

POLARIS FUEL PUMP NUT WRENCH

Mandatory tool to remove the fuel pump. PFA nut. Fits all Polaris. Replaces OEM #PU-50326. WR450F 04-06.



DESCRIPTION	PART #
POLARIS FUEL PUMP NUT WRENCH	3804-0059

POLARIS ATV REAR END LOCKING NUT TOOL

Compare to OEM #PA-47360. This tool is used to remove and install the locking nut on the rear gear-case.



DESCRIPTION	PART #
POLARIS ATV REAR END LOCKING NUT TOOL	3805-0163

STEERING KNUCKLE/BALL JOINT SEPARATOR

Consists of a tool body and both types of press bolts. Designed to separate the ball joint from the knuckle body without damaging the A-arm, ball joint stud or rubber boot. For Honda TRX250 Recon 97-01, TRX250R 86-89, TRX250X 87-88/91-92, TRX300EX 93-01, TRX450R 04-07 and TRX450ER 06-07 and Yamaha YFZ350 Banshee 87-01 and YFM350X Wolverine 87-01.



DESCRIPTION	PART #
STEERING KNUCKLE/BALL JOINT SEPARATOR	3805-0164

HONDA ATV SWING ARM TOOL

Great 2-in-1 tool for removing and reinstalling the pivot bolt lock nut. The other end is for removing the pivot bolt. Compare to Honda OEM #07908-4690003. Works on Honda 4-strokes.



DESCRIPTION	PART #
HONDA ATV SWING ARM TOOL	3805-0165

HONDA PINION BEARING NUT TOOL

Designed for removing and reinstalling the pinion bearing nut in Honda ATVs. 60 mm - Fits early ATC, TRX250/300/350. 64 mm - Fits TRX250/350/400/420/450/500/650/680.



DESCRIPTION	PART #
60 MM	3805-0166
64 MM	3805-0167

KAWASAKI ATV PINION NUT TOOL

This pinion nut tool fits Kawasaki KVF360/650/700/750 series. 12,7 mm (1/2") square drive.



DESCRIPTION	PART #
KAWASAKI ATV PINION NUT TOOL	3805-0168

POLARIS BALL JOINT REPLACEMENT TOOL

Used to remove and install the lower ball joints on Polaris ATV and Side x Side models with pressed-in ball joints on the front strut casting. Includes one ball joint install adapter, puller plate, receiving cup, forcing screw, 19,1 mm (3/4") - 16 x 16 L x 28 H nut, two 6,4 mm (1/4") - 20 x 70 L screws and two 6,4 mm (1/4") - 20 x 50 L screws.



DESCRIPTION	PART #
POLARIS BALL JOINT REPLACEMENT TOOL	3805-0169

POLARIS ATV/UTV TOOL KIT

Essential tool kit designed for Polaris ATV/UTV models. Kit Includes: Clutch spider nut driver (round) [OEM #2870338], Clutch spider nut driver (triangle) [OEM #2870341], rear end locking nut tool [OEM #PA-47360], flywheel puller M33 x P1.5 [OEM #PA-46075], Phoenix transmission locking nut tool [OEM #PA-47309], water pump and rotor service tool [OEM #PA-49316] and fuel pump nut wrench [OEM PU-50326].



DESCRIPTION	PART #
POLARIS ATV/UTV TOOL KIT	3812-0611

HONDA ATV TOOL KIT

Essential tool kit designed for Honda ATV models. Kit Includes: ATV steering knuckle/ball joint separator, ATV swing arm tool [OEM #07908-4690003], 64 mm pinion bearing nut tool, 60 mm pinion bearing nut tool and clutch puller tool [OEM #07933-HB3000A].



DESCRIPTION	PART #
HONDA ATV TOOL KIT	3812-0612

M1 ATV BOLT KIT

Includes hundreds of pieces developed to work with most ATVs. Includes hex/Allen bolts and nuts of multiple lengths/sizes/types, flat washers, lock washers, and two sizes of plastic rivets for fenders. The perfect kit to handle most repairs.



DESCRIPTION	PART #
M1 ATV BOLT KIT	2401-1008



DESCRIPTION	PART #
M.U.D. SHOP BANNER (58.5 CM (23") X 119 CM (47"))	9904-0986
M.U.D. TRACK BANNER (91 CM (36") X 213 CM (84"))	9904-0985

DESCRIPTION	PART #
AGROID COLORS DECAL (89 MM (3 1/2")) SOLD IN 6-PACK	4320-2023

DESCRIPTION	PART #
M.U.D. DECAL (12,5 CM (5"))	4320-2024

SPECIAL THANKS TO



OUR PARTNERS





- PROMO
- GARAGE
- RIDER
- ENGINE
- BRAKING
- SUSPENSION & DRIVE
- WHEELS & TIRES
- ELECTRICAL
- CONTROLS
- BODY
- LUGGAGE
- IMPLEMENTS & TOWING
- RACKS
- UTV
- WINCHES
- PLOWES



W A S E



3501 KENNEDY ROAD | JANESVILLE, WISCONSIN 53545

DISTRIBUTED
EXCLUSIVELY BY:

**PARTS
UNLIMITED**

**PARTS
CANADA**

**PARTS
EUROPE**

MOOSE UTILITY DIVISION IS A REGISTERED TRADEMARK. ALL RIGHTS RESERVED. COPYRIGHT 2019. LEMANS CORPORATION. THESE MATERIALS MAY NOT BE COPIED OR REPRODUCED IN ANY MANNER WITHOUT WRITTEN PERMISSION OF LEMANS CORPORATION. PRINTED IN THE USA.